

## SURGIPLUS INSTRUMENTS

Stadium Road Daska 51010

Sialkot- Pakistan .

Phone: +92 0300 7144593

Fax: +92-52-3254544

Email: [surgiplus@surgiplus.com.pk](mailto:surgiplus@surgiplus.com.pk)

[info@surgiplus.com.pk](mailto:info@surgiplus.com.pk)

[sales@surgiplus.com.pk](mailto:sales@surgiplus.com.pk)

# Percussion Hammers & Aesthesiometers



**01-101**  
TROEMNER  
Size: 245 mm

1/2



**01-102**  
DEJERINE  
Size: 200 mm

1/2



**01-103**  
DEJERINE  
With Needle  
Size: 210 mm

1/2



**01-104**  
TAYLOR  
Size: 195 mm

1/2



**01-105**  
BERLINER  
Size: 200 mm

1/2



**01-106**  
BUCK  
With Needle  
And Brush  
Size: 180 mm

1/2

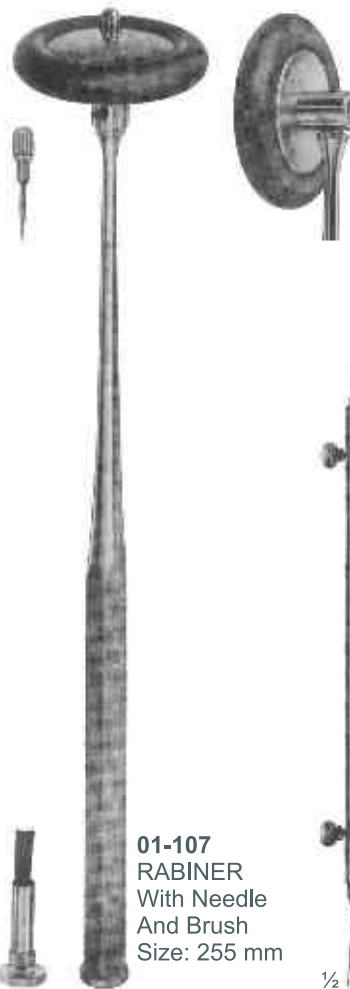

**01-107**  
RABINER  
With Needle  
And Brush  
Size: 255 mm

1/2



**01-108**  
ALY  
Size: 190 mm

1/2



**01-109**  
WARTENBERG  
Pinwheel For  
Neurological  
Examination  
Size: 185 mm

1/2



# Stethoscopes



**01-110**  
PINARD (Aluminum)  
Size: 155 mm

½



**01-111**  
aus Holz (Wooden)  
Size: 145 mm

½



**01-112**  
BOWLES  
Stethoscope  
With Diaphragm

¼



**01-113**  
ANESTOPHON

⅓



**01-114**  
FORD-BOWLES  
Duel Chest Piece  
With Two Outlets

¼



**01-115**  
BOWLES

¼

## Head Mirrors & Head Bands



**01-116**  
ZIEGLER  $\varnothing$  mm  
Head mirror only  
with rubber coating



**01-117**  
ZIEGLER  $\varnothing$  mm  
Head mirror only  
with metal coating



**01-118**  
ZIEGLER  
Head band of plastic black

**01-119**  
ZIEGLER  
Head band of plastic white



**01-120**  
MURPHY  
Head band of celluloid, white

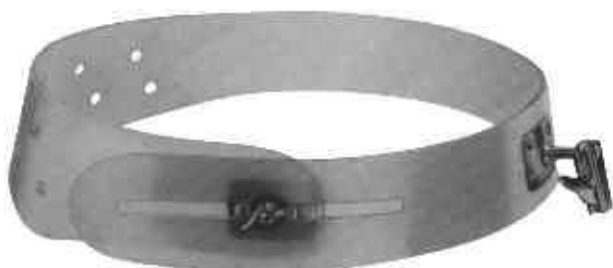

**01-121**  
Head band of plastic,  
white, soft pattern



**01-122**  
Head mirror with black  
plastic head band.

# Head Light

## 01-123

CLAR

Head light, 6 volt, with adjustable joint,  
white celluloid head band,  
cord with plugs for transformer

## 01-124

White celluloid head band, only, for

## 01-125

Spare mirror only, for



**01-126**  
spare bulb

## 01-127

CLAR

Head light, 6 volt, with adjustable joint,  
white celluloid head band, with foam rubber pad  
and cord with plugs for transformer

## 01-128

White celluloid head band, only, for head light

## 01-129

mirror only, for head light

spare foam rubber pad, for head band

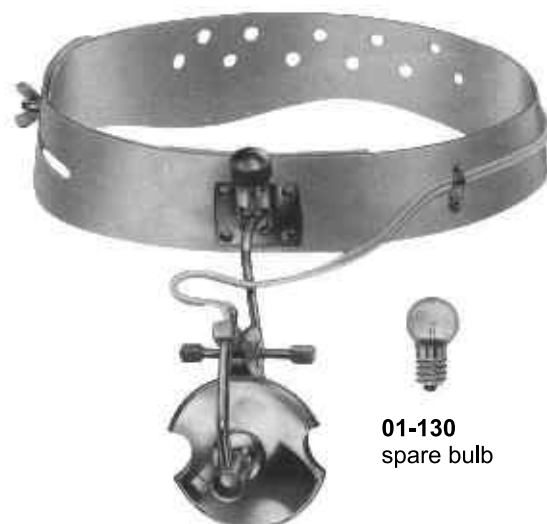

**01-130**  
spare bulb

## 01-131

CLAR

Head light, 6 volt, with adjustable joint,  
white plastic head band,  
cord with plugs for transformer



**01-132**  
spare bulb

# Tongue Depressors

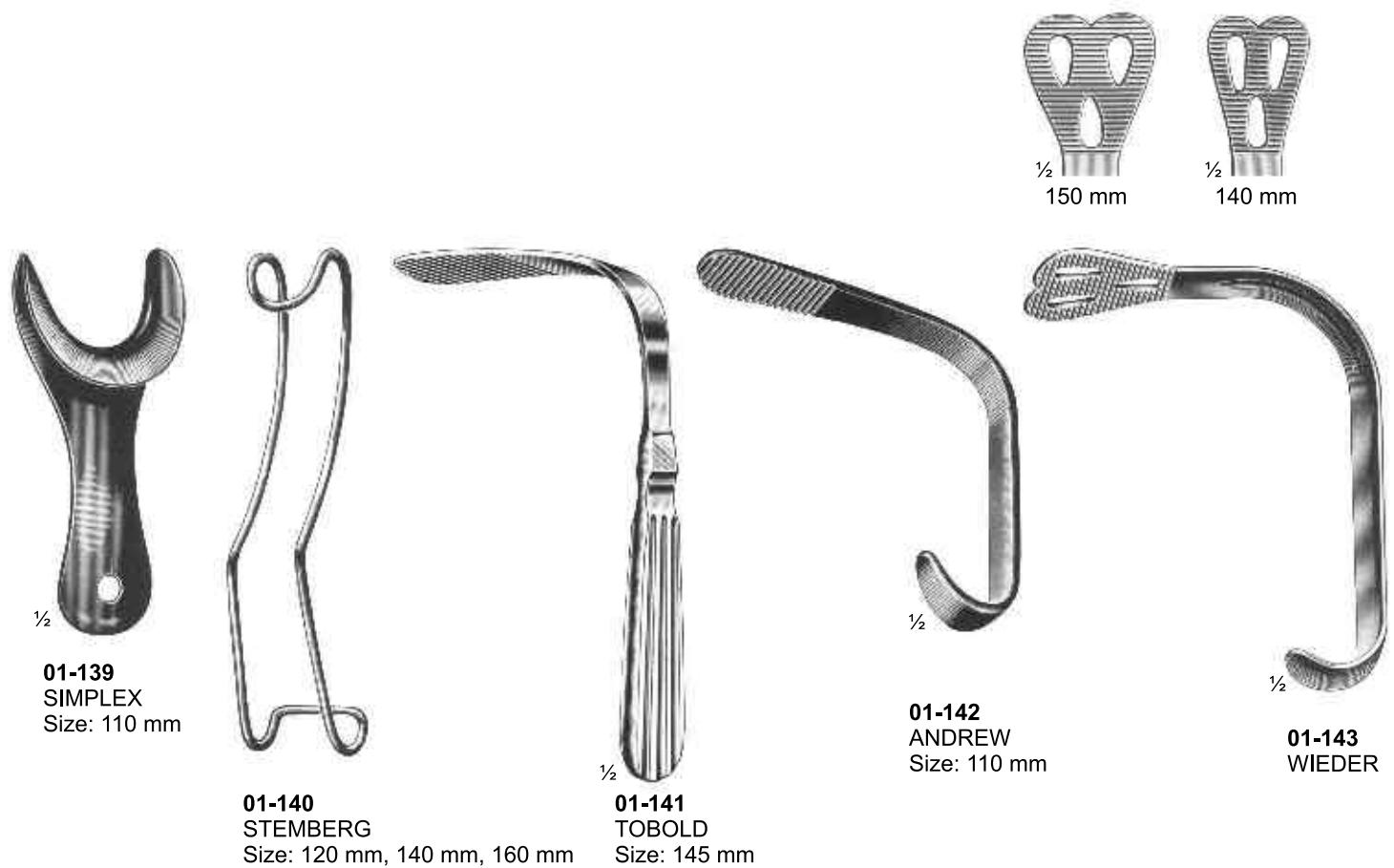
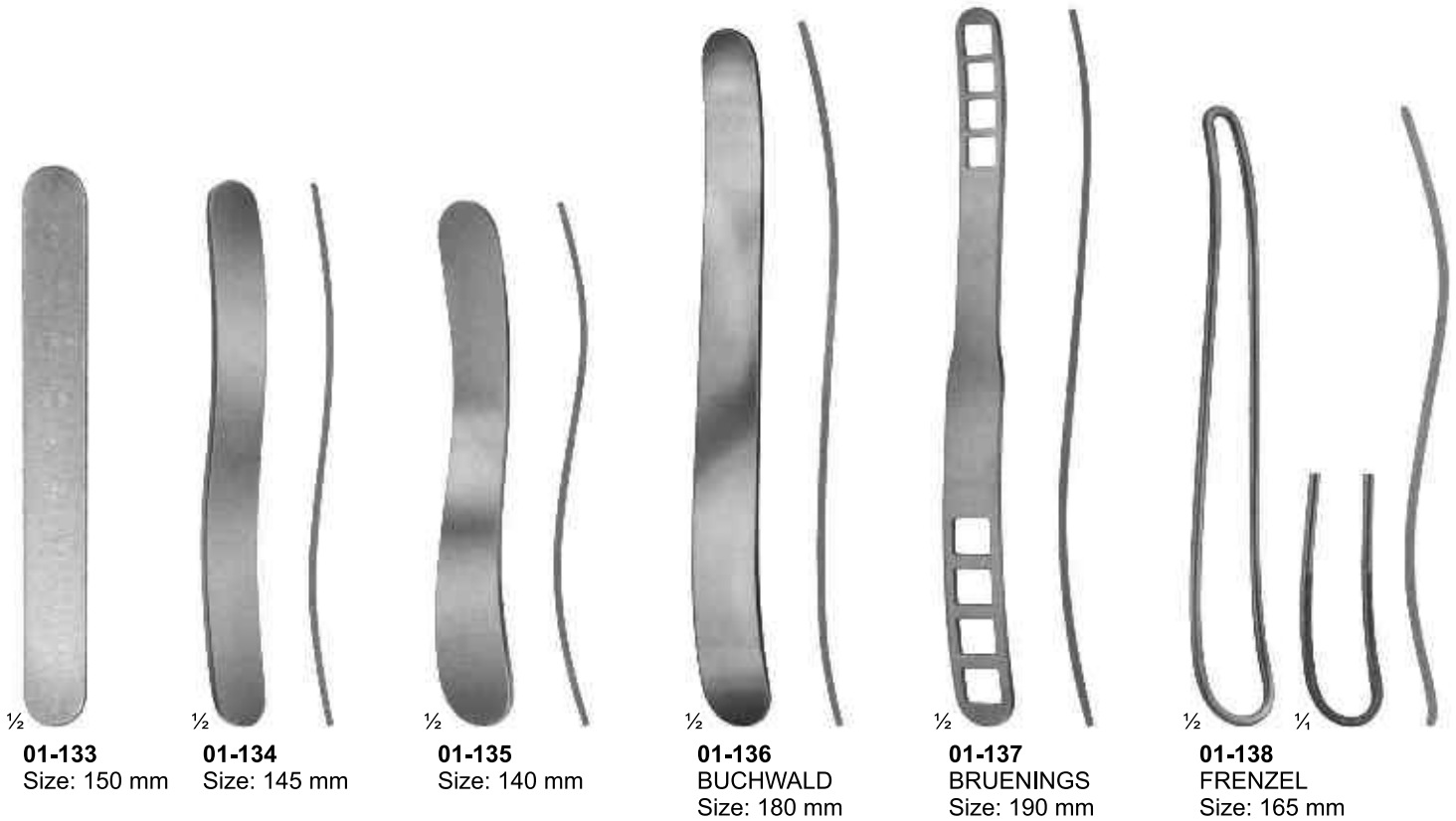



# Tongue Depressors



1/2

**01-144**  
SCHIMMELBUSCH  
Ether Mask



1/2

**01-145**  
HEISTER  
Mouth Gag  
Size: 130 mm



1/2

**01-146**  
FERGUSSON-ACKLAND  
Mouth Gag  
Size: 145 mm



1/2

**01-147**  
DENHARDT  
Mouth Gag With Silicon  
Inserts, Interchangeable  
Size: 125 mm



1/2

**01-148**  
ROSER KONIG  
Mouth Gag  
Size: 160 mm, 185 mm



1/2

**01-149**  
YOUNG  
Size: 165 mm



1/4

1 Pair Of  
Rubber Pads

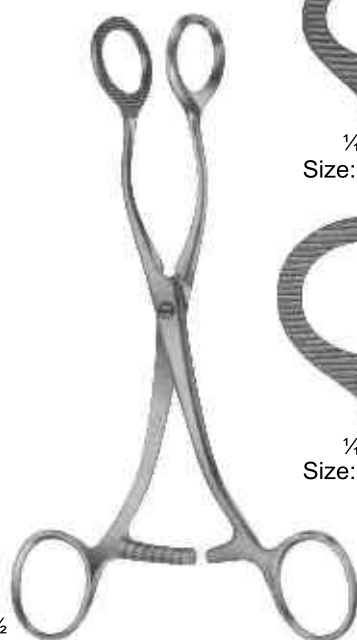

1/2

**01-150**  
COLLIN  
Size: 160 mm, 170 mm



1/4

Size: 160 mm



1/4

Size: 170 mm

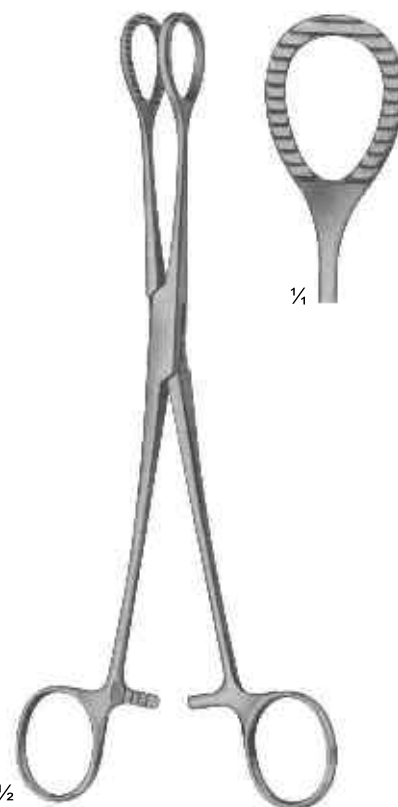

1/2

**01-151**  
HEYWOOD-SMITH modif.  
Size: 215 mm

# Blood Lancets & Laryngeal Mirrors



**01-152**  
FRANCKE  
Automatic Blood Lancet



**01-153**  
KOLLE  
Microscopic Needle Holder  
With Plastic Handle  
Size: 240 mm



Fig. 000



Fig. 00



Fig. 0

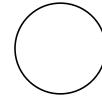

Fig. 1

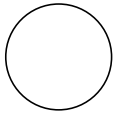

Fig. 2

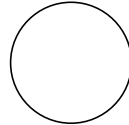

Fig. 3

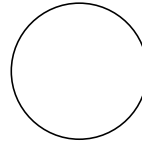

Fig. 4

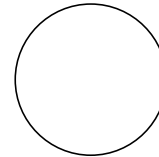

Fig. 5

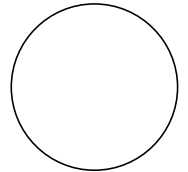

Fig. 6

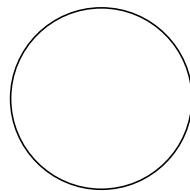

Fig. 7

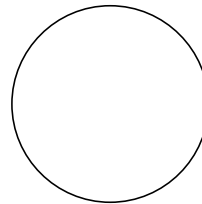

Fig. 8

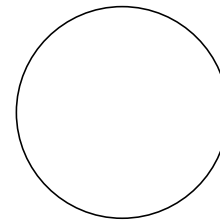

Fig. 9

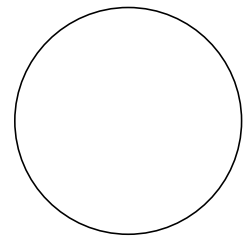

Fig. 10



**01-158**  
Spare Mirrors Only  
Size: 12 mm



**01-159**  
Spare Mirrors Only  
Size: 14 mm



**01-154**  
Laryngeal Mirrors With  
Hexagonal Handle  
Size: 180 mm



**01-155**  
Mirror Handle  
Size: 110 mm



**01-156**  
Mirror Handle  
Size: 105 mm



**01-157**  
MICHEL  
Rhinoscopic Mirrors With  
Interchangeable Mirror Inserts  
Size: 250 mm

# Diagnostic Sets



**01-160 - 162**  
MAGILL



**01-160**  
Infants  
Size: 150 mm



**01-161**  
Children  
Size: 200 mm



**01-162**  
Adults  
Size: 250 mm



**01-163**  
Medium battery handle  
only, 25 mm diam.



**01-163-A**  
Spare bulb  
2.7 volt, for  
otoscopes



**01-163-B**  
Spare bulb  
2.6 volt, for  
ophthalmoscopes



**01-164**  
Otoscope Set, Consists Of  
Battery Handle Without Batteries,  
3 Ear Specula, 1 Bulb In Velvet Lined Case

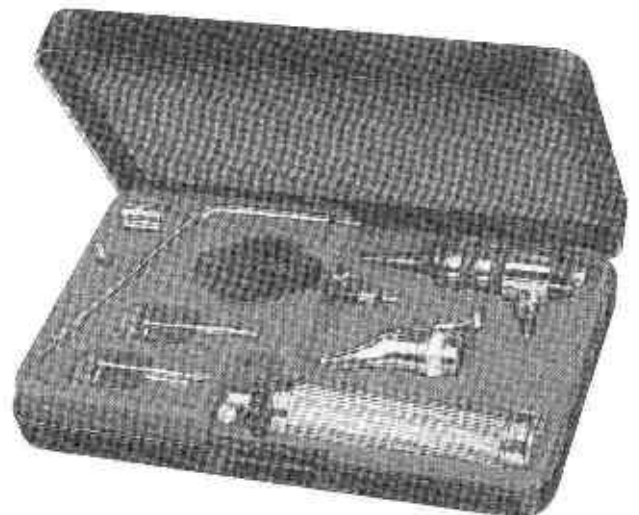

**01-165**  
Diagnostic Set, Otoscope With Three Specula,  
Nasal Speculam, Lamp Holder, Two Laryngeal  
Mirrors, Tongue Blade Holder

# Diagnostic Sets

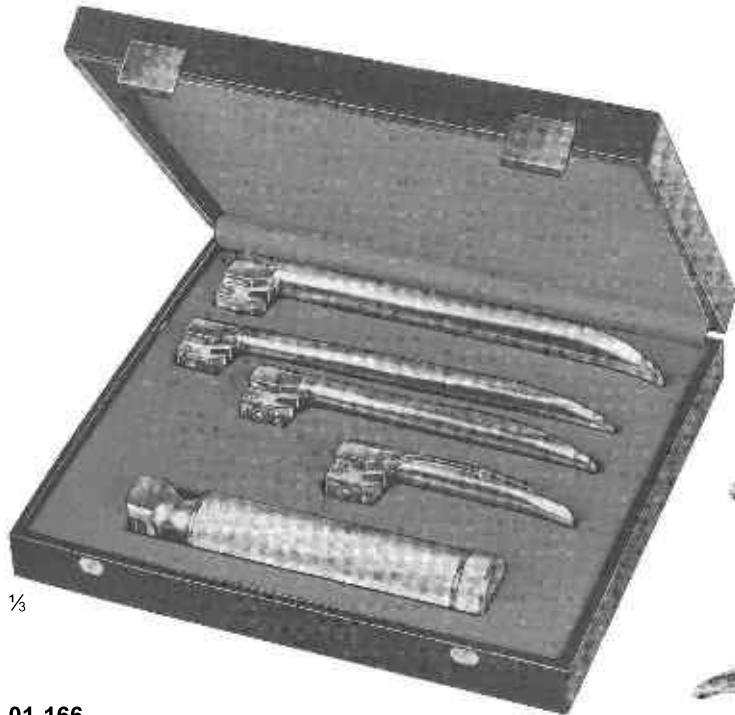

1/3

**01-166**  
**MILLER**  
 Laryngoscope Set, Consists Of Battery Handle ( Without Battery )  
 With Four Miller Laryngoscope Blades

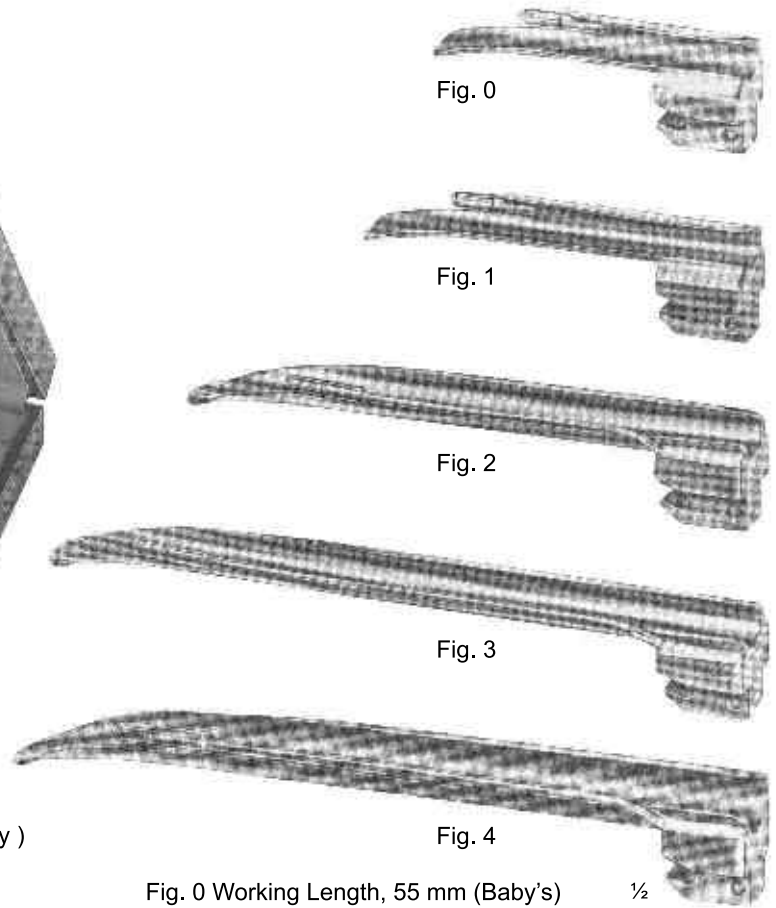

Fig. 0

Fig. 1

Fig. 2

Fig. 3

Fig. 4

Fig. 0 Working Length, 55 mm (Baby's) 1/2  
 Fig. 1 Working Length, 80 mm (Children's)  
 Fig. 2 Working Length, 130 mm (Adolescent's)  
 Fig. 3 Working Length, 170 mm (Women's)  
 Fig. 4 Working Length, 180 mm (Men's)



1/3

**01-167**  
**GUEDEL-NEGUS**  
 Laryngoscope Set, Consists Of Battery Handle ( Without Battery )  
 With Four Miller Laryngoscope Blades

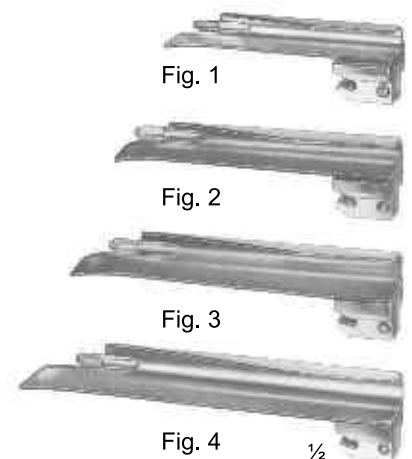

Fig. 1

Fig. 2

Fig. 3

Fig. 4

Fig. 1 Working Length, 70 mm (Children's) 1/2  
 Fig. 2 Working Length, 90 mm (Adolescent's)  
 Fig. 3 Working Length, 110 mm (Women's)  
 Fig. 4 Working Length, 135 mm (Men's)



# Diagnostic Sets



1/3

**01-168**  
 McIntosh  
 Laryngoscope Set, Consists Of Battery Handle ( Without Battery )  
 With Three McIntosh Blades, Fig. 1, Fig. 2, Fig. 3

**01-169**  
 McIntosh  
 Laryngoscope Set, Consists Of Battery Handle ( Without Battery )  
 With Five McIntosh Blades, Fig. 1, Fig. 2, Fig. 3, Fig. 4, Fig. 5



Fig. 0



Fig. 1



Fig. 2



Fig. 3

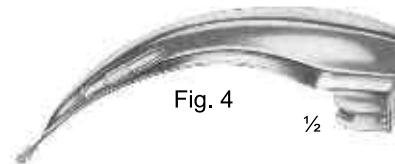

Fig. 4

1/2

Fig. 0 Working Length, 55 mm (Baby's)  
 Fig. 1 Working Length, 75 mm (Children's)  
 Fig. 2 Working Length, 90 mm (Adolescent's)  
 Fig. 3 Working Length, 110 mm (Women's)  
 Fig. 4 Working Length, 135 mm (Men's)



1/3

**01-170**  
 FOREGGER  
 Laryngoscope Set, Consists Of  
 Battery Handle ( Without Battery )  
 With Three Foregger Blades,  
 Fig. 1, Fig. 2, Fig. 3,

**01-171**  
 FOREGGER  
 Laryngoscope Set, Consists Of  
 Battery Handle ( Without Battery )  
 With Five Foregger Blades,  
 Fig. 1, Fig. 2, Fig. 3, Fig. 4, Fig. 5



Fig. 1



Fig. 2



Fig. 3



Fig. 4

1/2

Fig. 1 Working Length, 70 mm (Children's)  
 Fig. 2 Working Length, 90 mm (Adolescent's)  
 Fig. 3 Working Length, 110 mm (Women's)  
 Fig. 4 Working Length, 135 mm (Men's)



1/2

**01-172**  
 Fiber Optic  
 Battery Handle



1/2

**01-173**  
 Fiber Optic  
 Battery Handle



1/4

**01-174**  
 Replacement Lamp  
 ( Krypton ) 2.5 V



1/4

**01-175**  
 Replacement Lamp  
 ( Halogen ) 2.5 V

# Examination & Measuring Instruments



**01-176**  
Caliper Of Aluminum  
Up To 180 mm

½



**01-177**  
VERNIER  
Universal Caliper Of Steel  
Up To 120 mm

½



**01-178**  
CAROLL  
Size: 140 mm

½



**01-179**  
TOWNLEY  
Size: 100 mm

½



½

**01-180**  
COLLIN  
Druck Pressure 72 kg  
Size: 125 mm



½

**01-181**  
BERTILLON  
Caliper For Measuring The Head  
Size: 320 mm



¼

**01-182**  
CASTROVIEJO  
Caliper



½

**01-183**  
MOLTGEN  
Goniometer



**01-185**  
Size: 150 mm



**01-184**  
Size: 500 mm



# Dissecting Knives



**02-101 - 110**  
Fig. 1 - 10



**02-101**  
Fig. 1



**02-102**  
Fig. 2

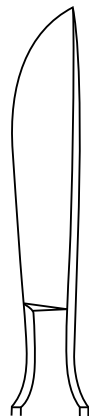

**02-103**  
Fig. 3



**02-104**  
Fig. 4



**02-105**  
Fig. 5



**02-106**  
Fig. 6



**02-107**  
Fig. 7



**02-108**  
Fig. 8



**02-109**  
Fig. 9



**02-110**  
Fig. 10

# Autopsy & Cartilage Knives

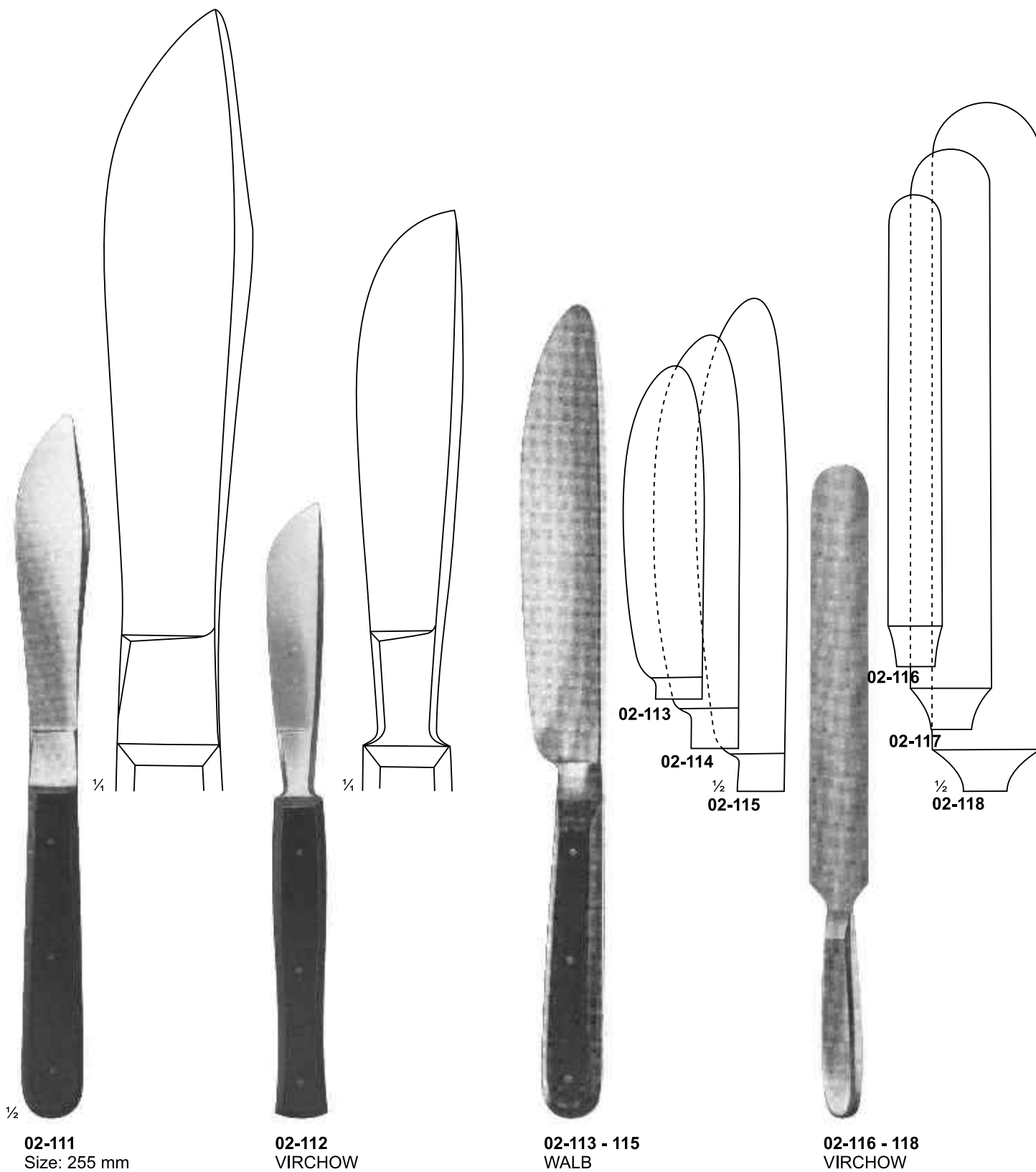



# Scalpels, Tenotomes & Resection Knives

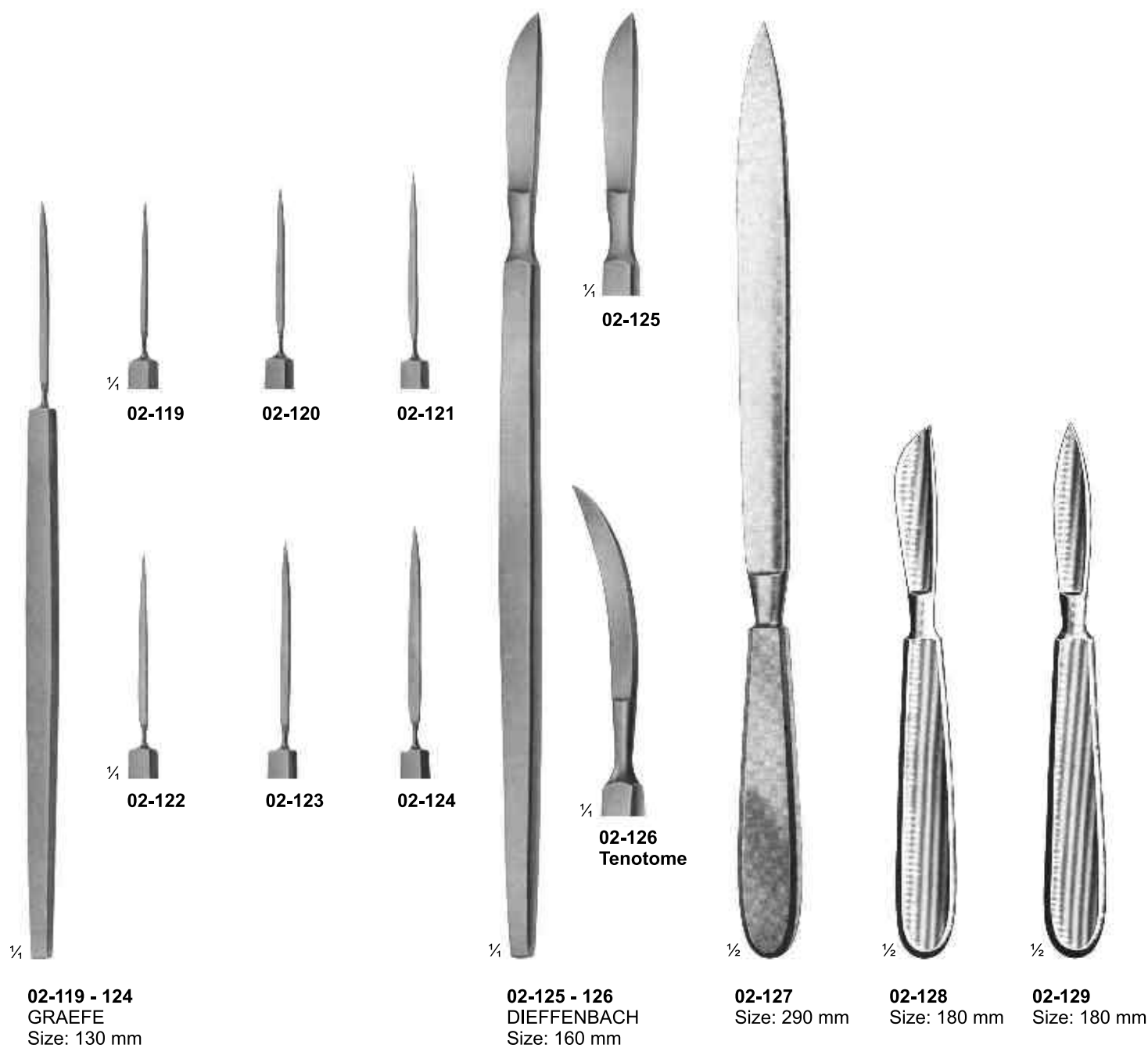

# Scalpels, Tenotomes

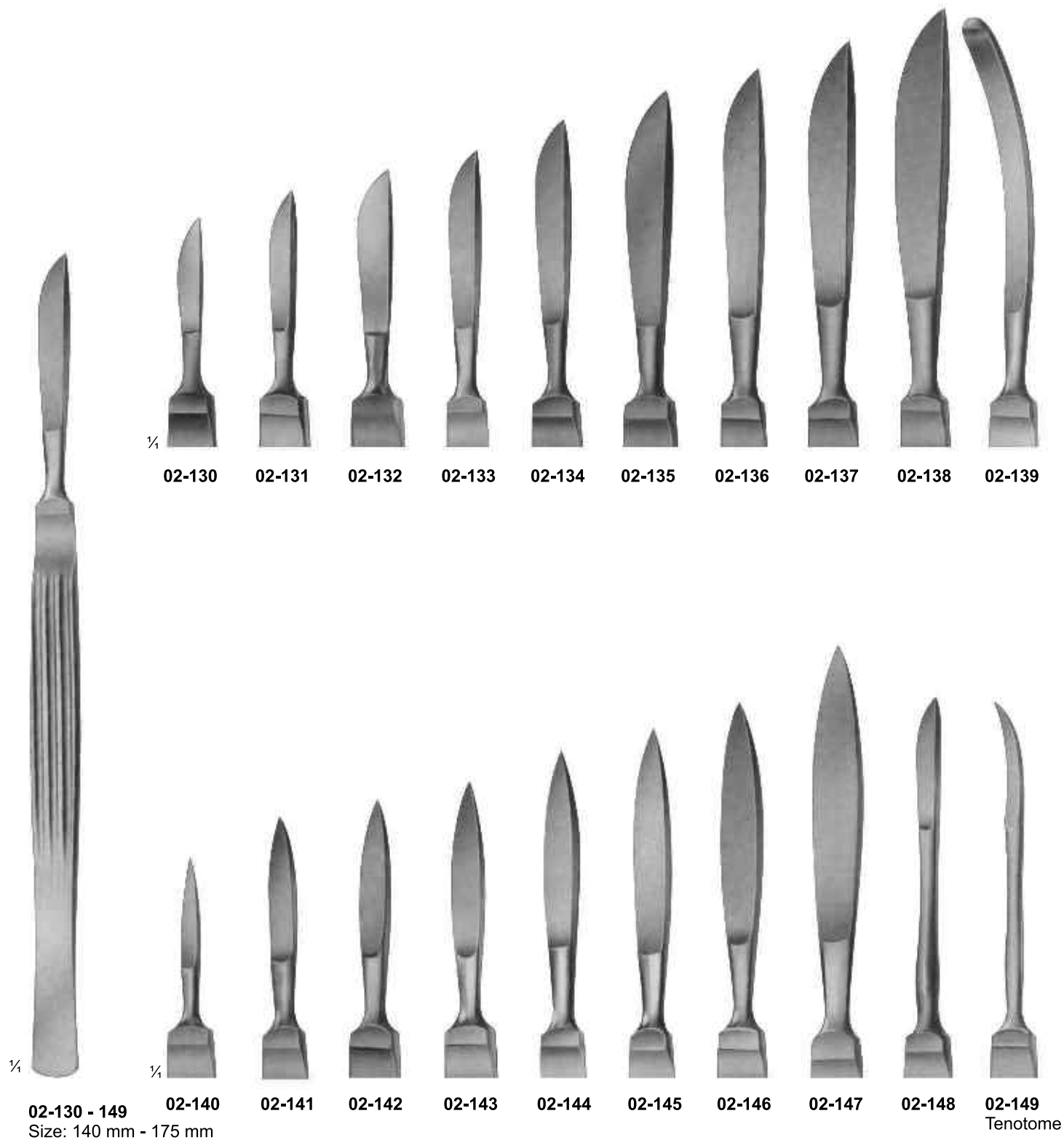

# Amputating Knives, Cartilage Knives, Autopsy Knives

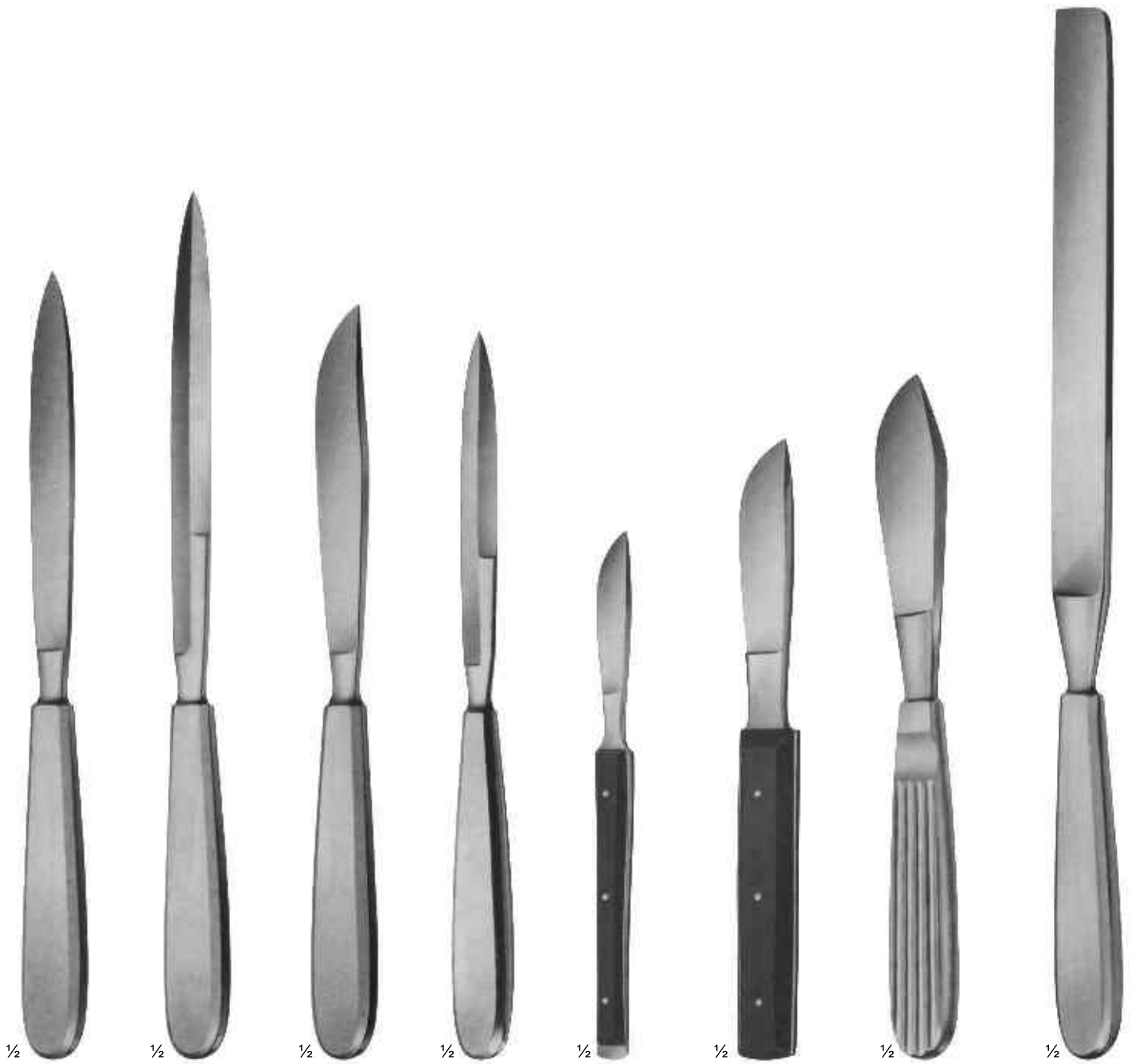

<b>02-150</b> Size: 130 mm	<b>02-154</b> CATLIN Size: 160 mm	<b>02-155</b> LANGENBECK Size: 120 mm	<b>02-156</b> Size: 110 mm	<b>02-157</b> Size: 55 mm	<b>02-158</b> Size: 70 mm	<b>02-159</b> Size: 80 mm	<b>02-160</b> Size: 195 mm
<b>02-151</b> Size: 160 mm	Blade Length	Blade Length	Blade Length	Blade Length	Blade Length	Blade Length	Blade Length
<b>02-152</b> Size: 190 mm	Amputating	Flap Knives	Interosseous	With Raspatory,	Wooden Handle	Metal Handle	Metal Handle
<b>02-153</b> Size: 200 mm	Knives		Knives	Wooden Handle			
Blade Length							
Amputating Knives							

# Cone Knives, Myomatome, Trigeminal & Tonsil Knives





# Scalpels, Dura Knives & Comedone Extractors

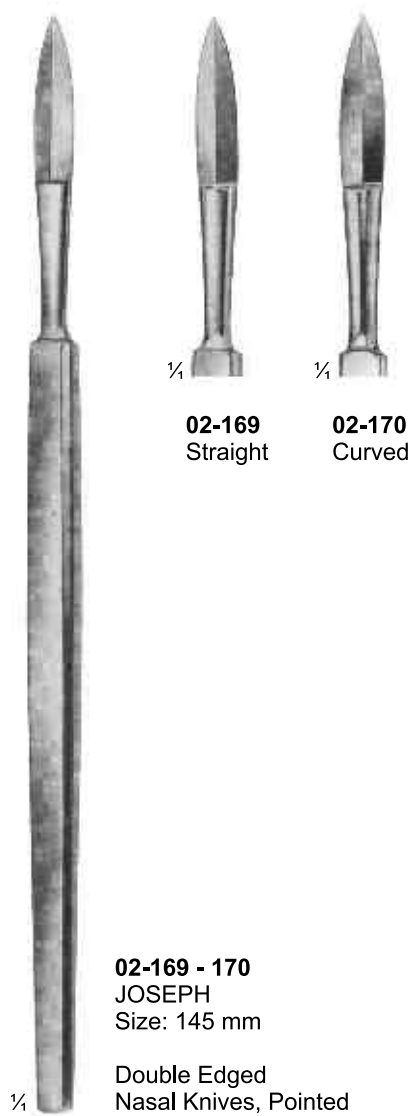

**02-169**  
Straight

**02-170**  
Curved

**02-169 - 170**  
JOSEPH  
Size: 145 mm

Double Edged  
Nasal Knives, Pointed

1/4

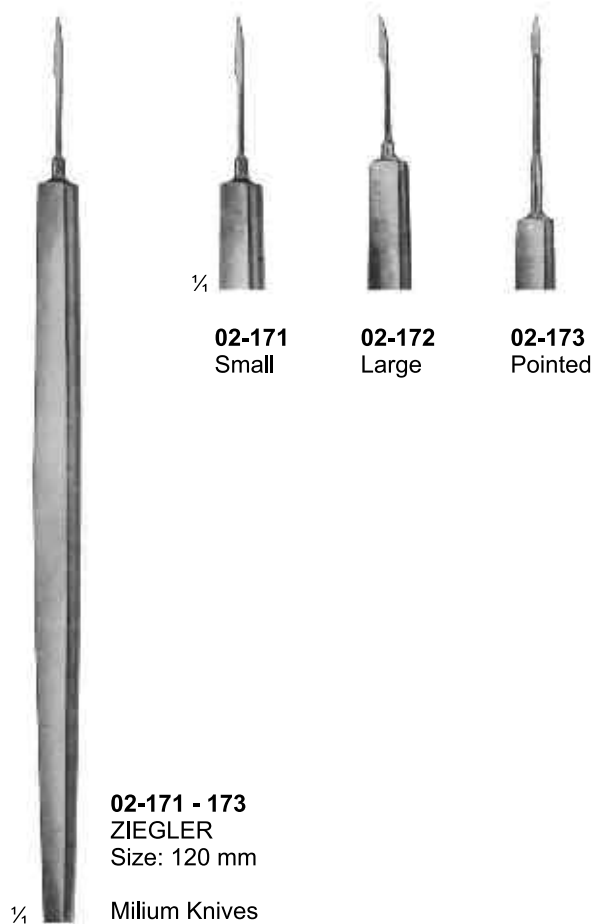

**02-171**  
Small

**02-172**  
Large

**02-173**  
Pointed

**02-171 - 173**  
ZIEGLER  
Size: 120 mm

Milium Knives

1/4



**02-174**  
VIDAL  
Lupus Scraper  
Size: 135 mm

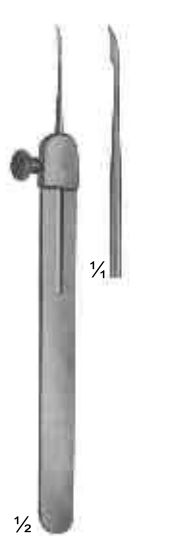

**02-175**  
MONCORPS  
Milium Knives  
Size: 130 mm



**02-176**  
SAALFELD  
Size: 100 mm

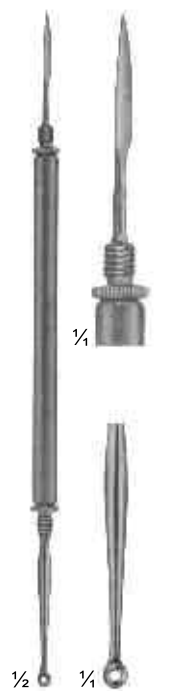

**02-177**  
HEBRA  
Size: 180 mm



**02-178**  
Size: 145 mm



**02-179**  
UNNA  
Size: 145 mm

# Razor Blade Holders & Breakers



**02-180**  
TROUTMAN-CHRIS  
Size: 100 mm



**02-181**  
TROUTMAN-CHRIS  
Size: 100 mm



**02-182**  
Size: 110 mm



**02-183**  
CASTROVIEJO  
Size: 130 mm



**02-184**  
Size: 185 mm

# Scalpel Handles

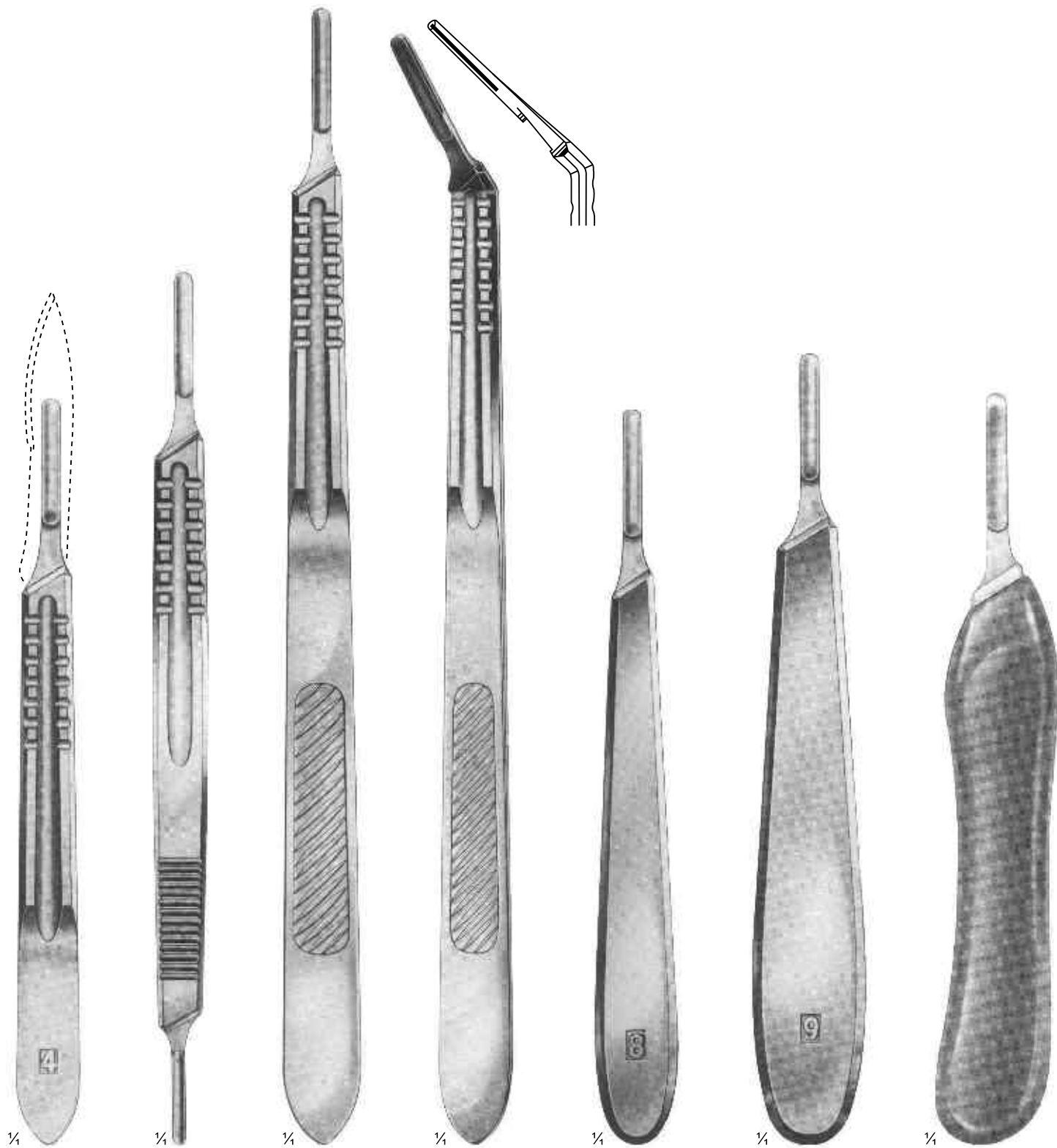

**02-185**  
STANDARD  
No. 4  
Solid

**02-186**  
Double Handel  
No. 4 + No. 3  
Solid

**02-187**  
No. 4 L  
Straight  
Solid

**02-188**  
No. 4 L  
Solid Angled

**02-189**  
COLLIN  
No. 8  
Hollow

**02-190**  
COLLIN  
No. 9  
Hollow

**02-191**  
Plastic

# Scalpel Handles

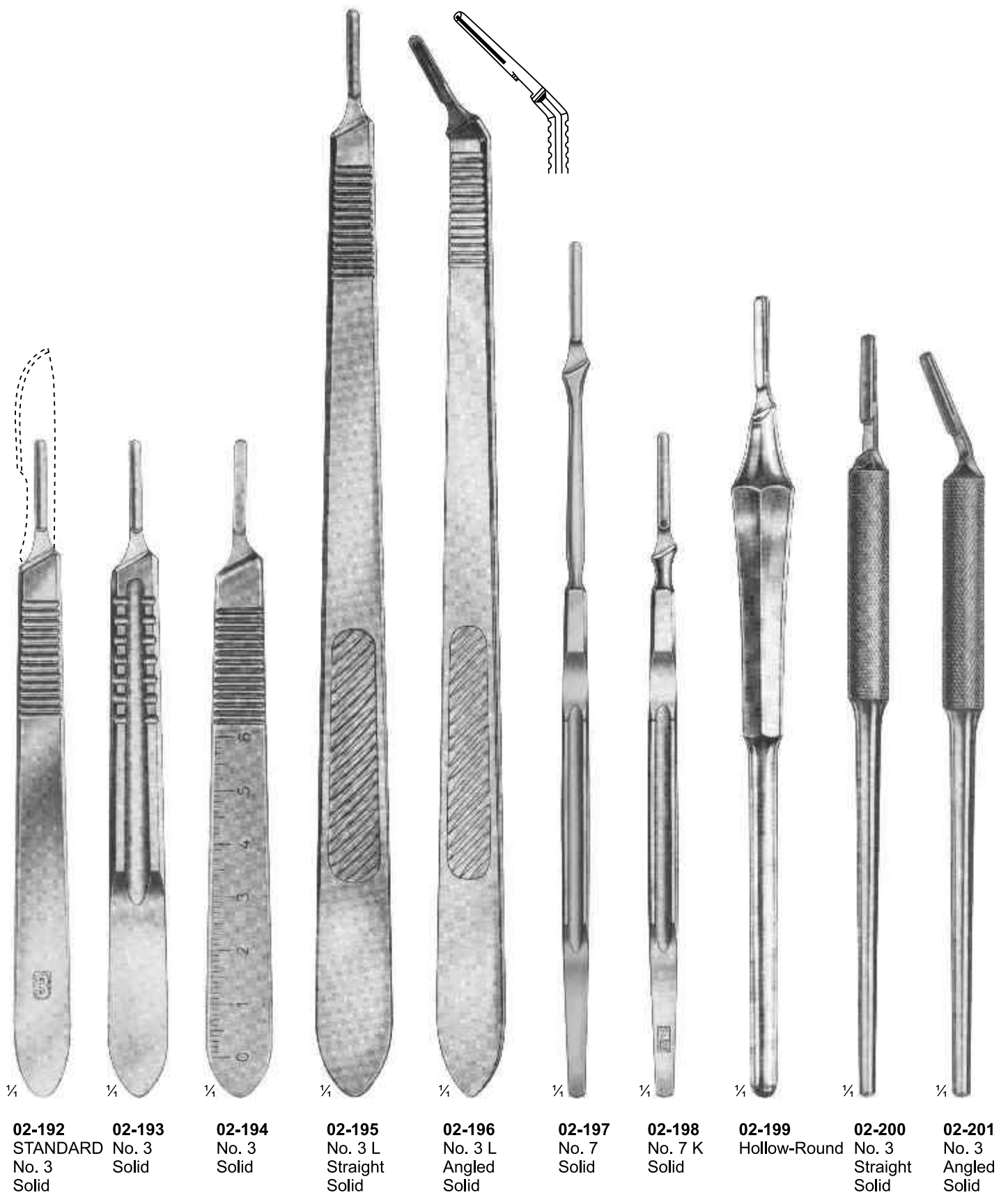

# Micro Scissors, "Spring Type" Flat Handles

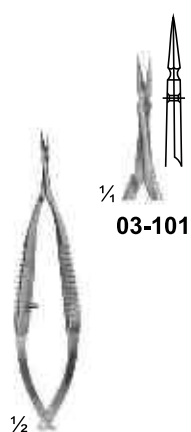

**03-101 - 103**  
VANNAS  
Size: 85 mm

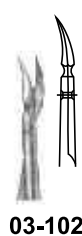

**03-102**



**03-103**

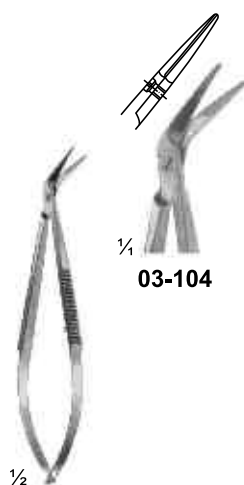

**03-104 - 105**  
CASTROVIEJO  
Size: 95 mm

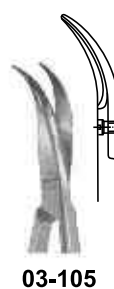

**03-105**



**03-106**  
NOYES  
Size: 125 mm

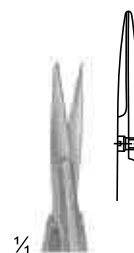

$\frac{1}{4}$

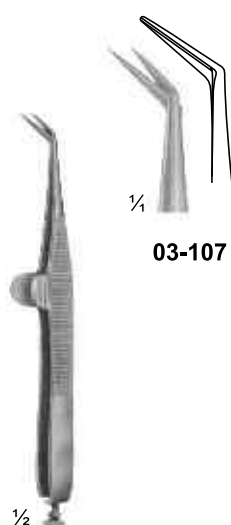

**03-107 - 108**  
WECKER  
Eye Scissor  
Size: 110 mm

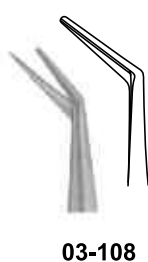

**03-108**

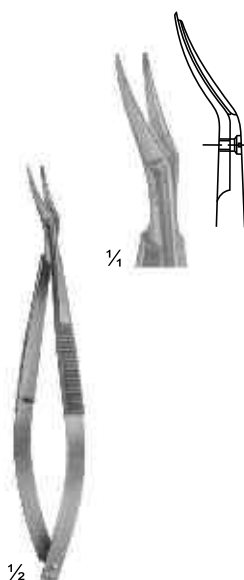

**03-109**  
CASTROVIEJO  
Eye Scissor  
Size: 115 mm

$\frac{1}{4}$



**03-110 - 111**  
CASTROVIEJO  
Eye Scissor  
Size: 110 mm

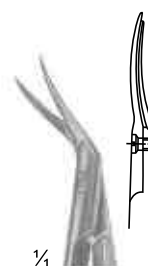

$\frac{1}{4}$

**03-110**



**03-111**

# Micro Scissors, "Spring Type" Flat Handles

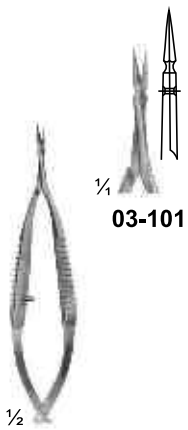

**03-101 - 103**  
VANNAS  
Size: 85 mm

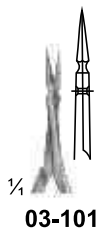

**03-101**



**03-102**



**03-103**

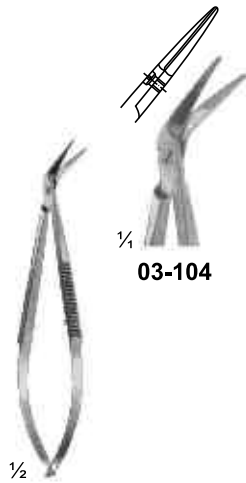

**03-104 - 105**  
CASTROVIEJO  
Size: 95 mm



**03-104**

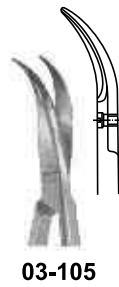

**03-105**



**03-106**  
NOYES  
Size: 125 mm

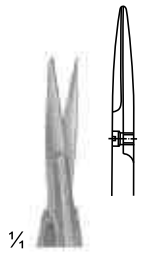

**1/4**

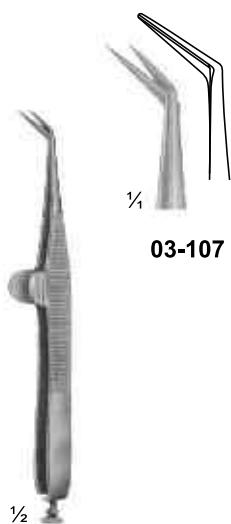

**03-107 - 108**  
WECKER  
Eye Scissor  
Size: 110 mm



**03-107**

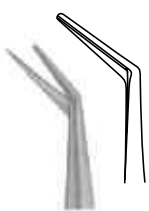

**03-108**

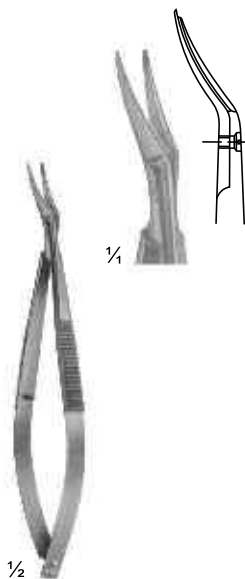

**03-109**  
CASTROVIEJO  
Eye Scissor  
Size: 115 mm

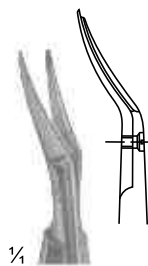

**1/4**



**03-110 - 111**  
CASTROVIEJO  
Eye Scissor  
Size: 110 mm

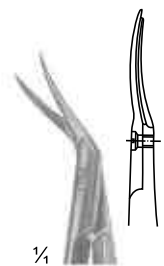

**03-110**



**03-111**

# Micro Scissors, "Spring Type" Flat Handles

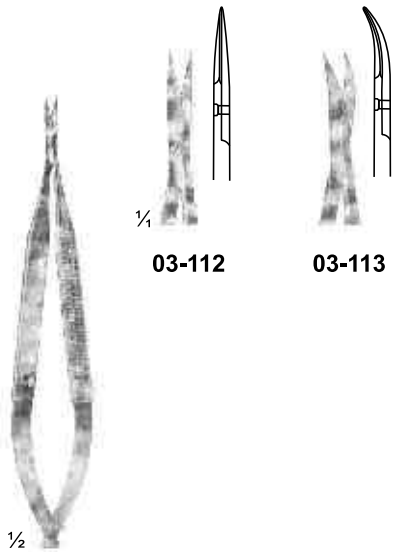

**03-112 - 113**  
Size: 120 mm

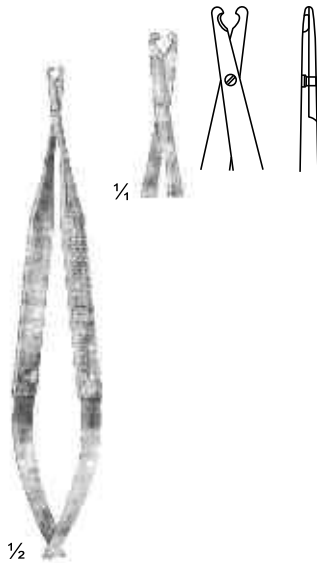

**03-114**  
BIEMER  
Vein Scissor  
Size: 130 mm

**03-115**  
Size: 160 mm

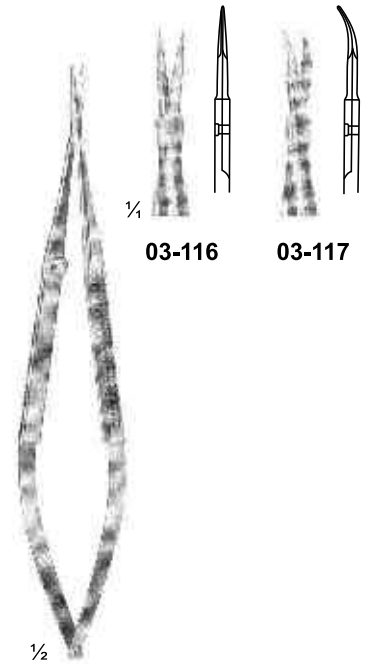

**03-116 - 117**  
VANNAS  
Size: 160 mm

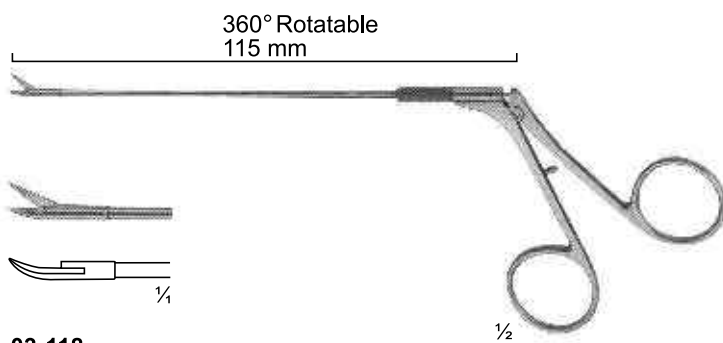

**03-118**  
CASPAR  
Micro Scissor Curved  
Size: 115 mm

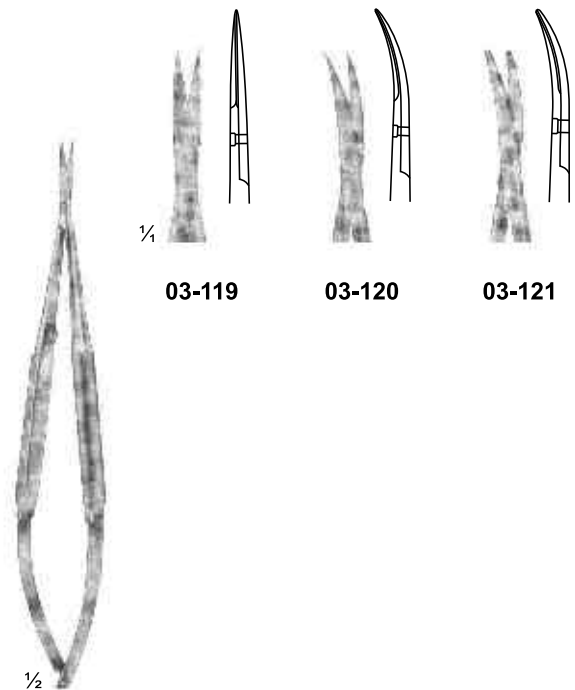

**03-119 - 121**  
Micro Dissecting Scissor  
Size: 145 mm

# Micro Scissors, "Spring Type" Bayonet Shape

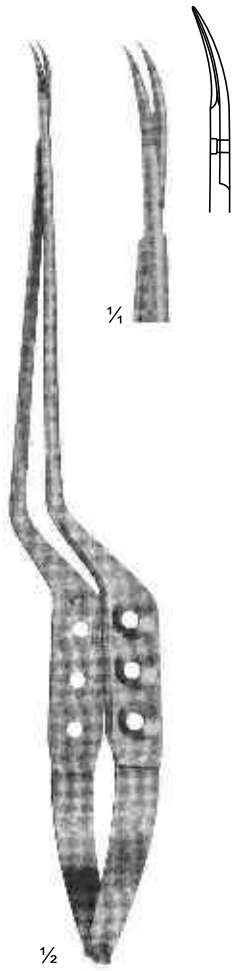

**03-122**  
YASARGIL  
Size: 245 mm

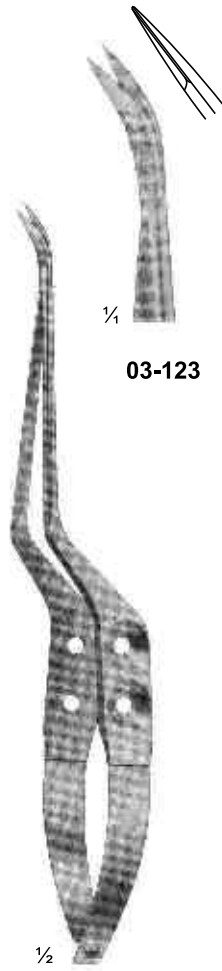

**03-123**



**03-124**

**03-123 - 124**  
Laterally Angled  
Size: 200 mm

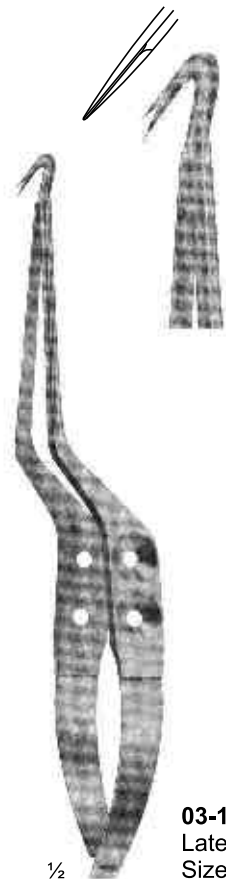

**03-125**  
Laterally Angled  
Size: 190 mm

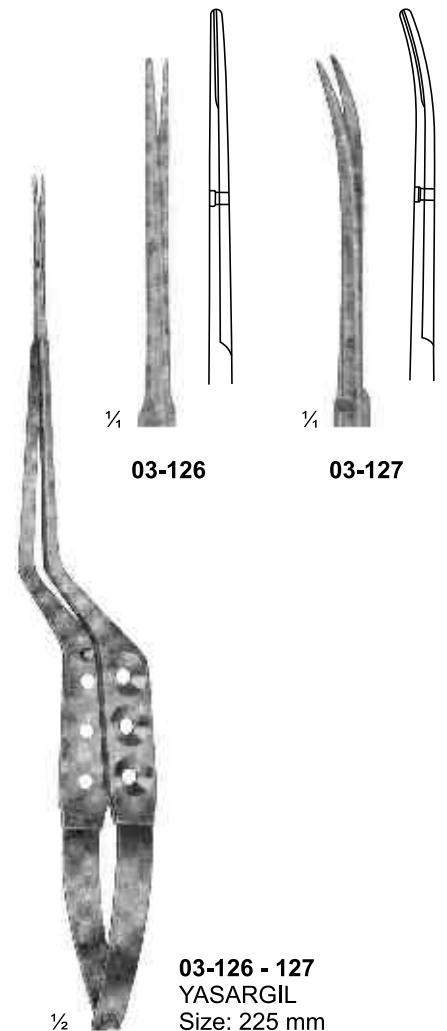

**03-126**

**03-127**

**03-126 - 127**  
YASARGIL  
Size: 225 mm



# Delicate Scissors

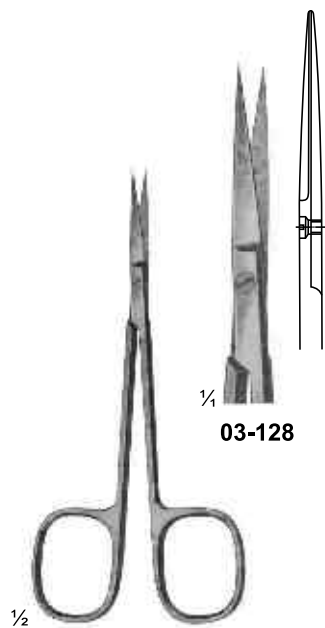

03-128

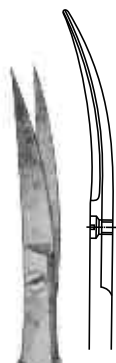

03-129

03-128 - 129  
Size: 120 mm

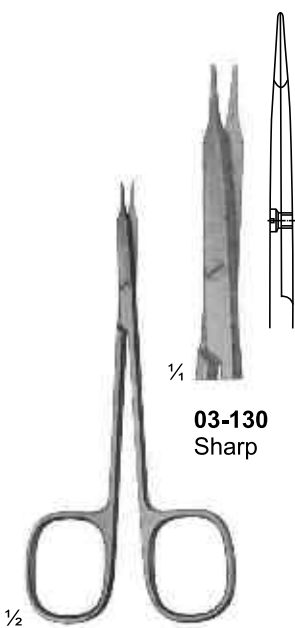

03-130  
Sharp

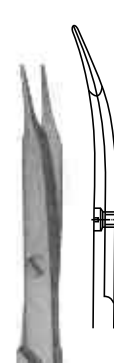

03-131  
Sharp

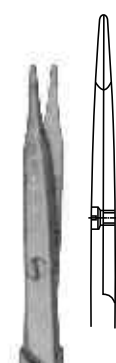

03-132  
Blunt

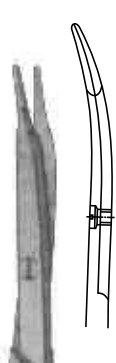

03-133  
Blunt

03-130 - 133  
STEVENS  
Dissecting Scissors  
Size: 115 mm

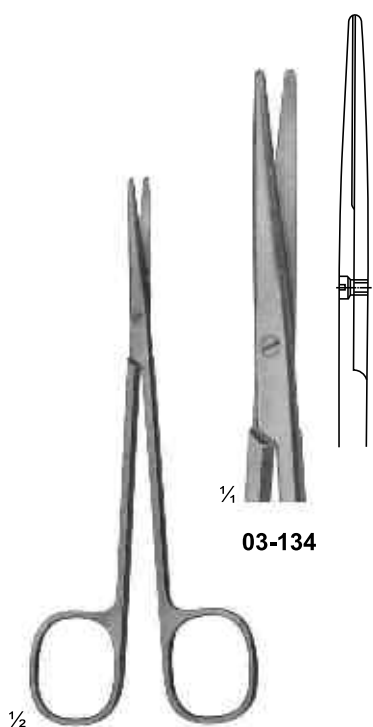

03-134

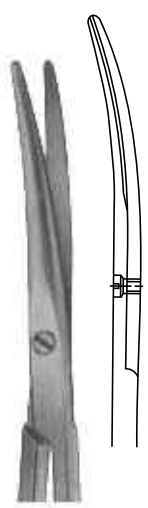

03-135

03-134 - 135  
METZENBAUM  
Dissecting Scissors  
Size: 145 mm

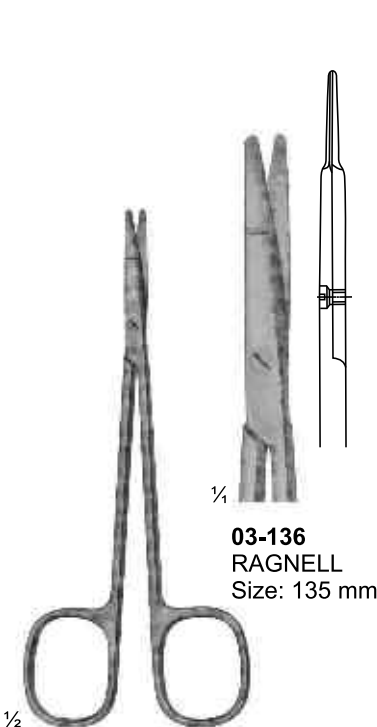

03-136  
RAGNELL  
Size: 135 mm

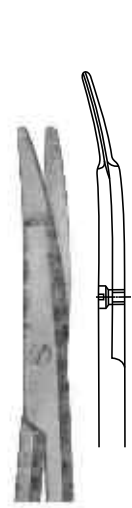

03-137  
RAGNELL  
Size: 135 mm

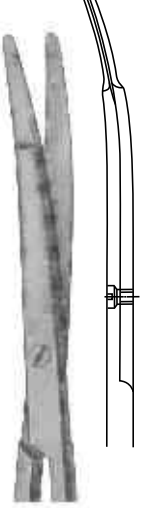

03-138  
Size: 150 mm

03-136 - 138  
Special flat points for  
dissecting and  
undermining the skin  
Size: 145 mm

# Delicate Scissors

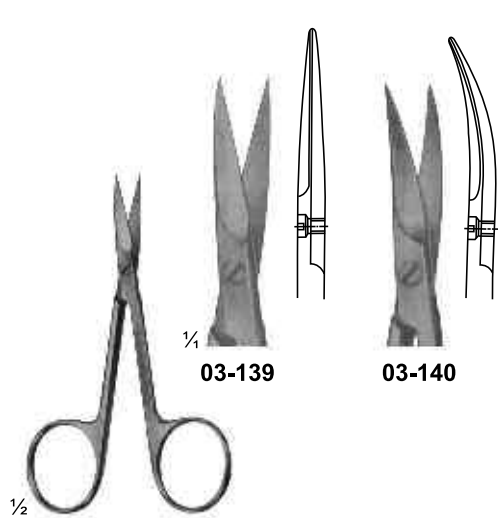

**03-139**

**03-140**

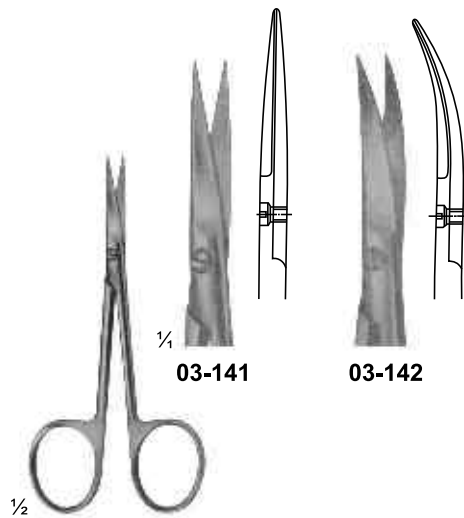

**03-141**

**03-142**

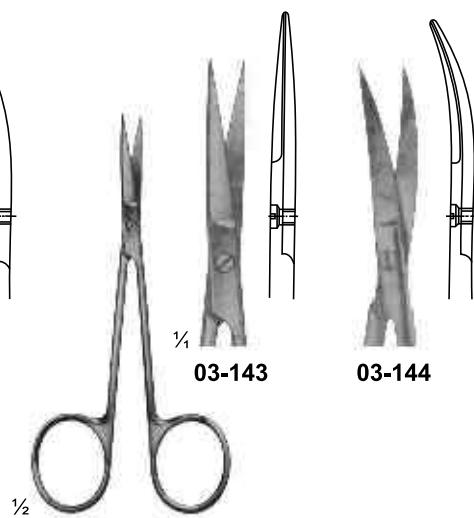

**03-143**

**03-144**

**03-139 - 140**  
Size: 90 mm

**03-141 - 142**  
Size: 95 mm

**03-143 - 144**  
Size: 105 mm

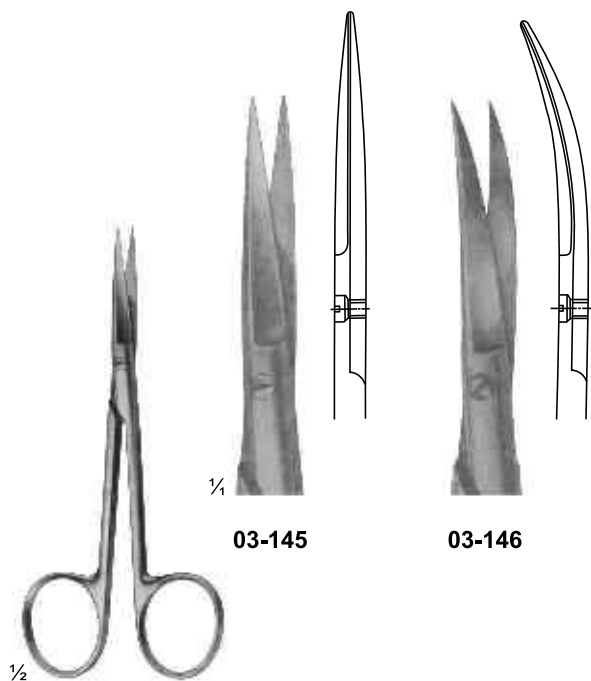

**03-145**

**03-146**

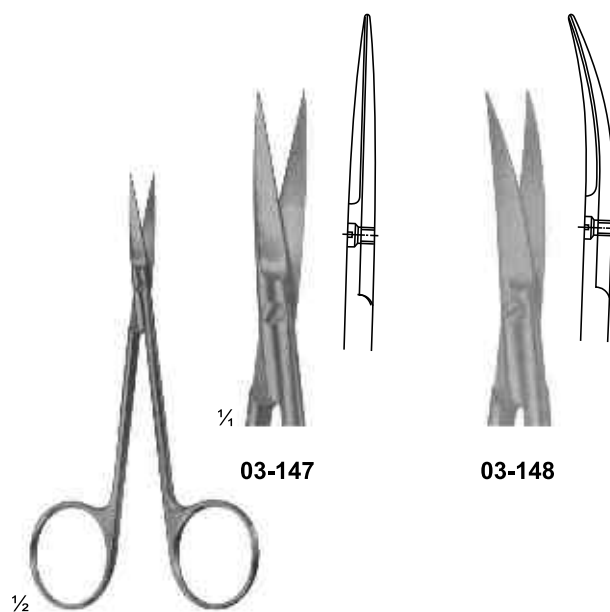

**03-147**

**03-148**

**03-145 - 146**  
Size: 120 mm

**03-147 - 148**  
Size: 115 mm

# Delicate Scissors



1/2

**03-149 - 151**  
Size: 120 mm

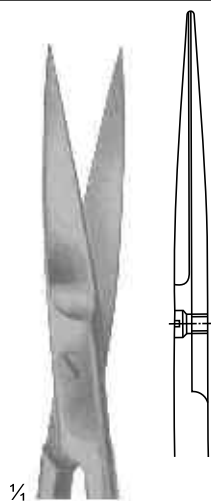

1/4

**03-149**

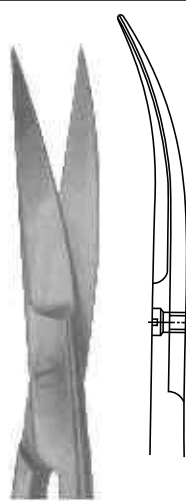

**03-150**

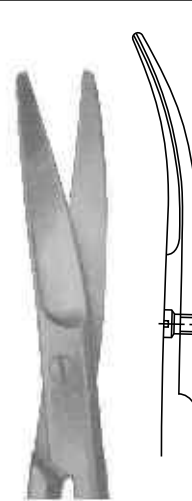

**03-151**



1/2

**03-152 - 155**  
Size: 130 mm

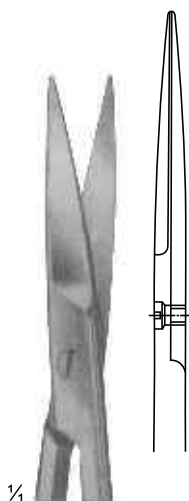

1/4

**03-152**

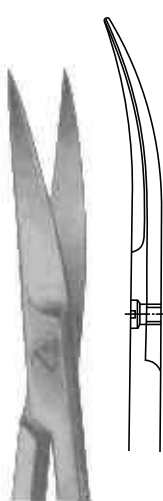

**03-153**

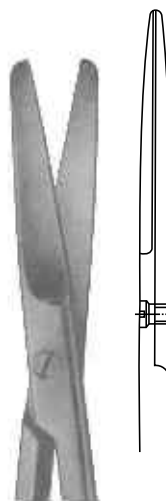

**03-154**

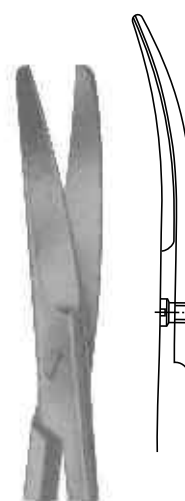

**03-155**

# Delicate Scissors

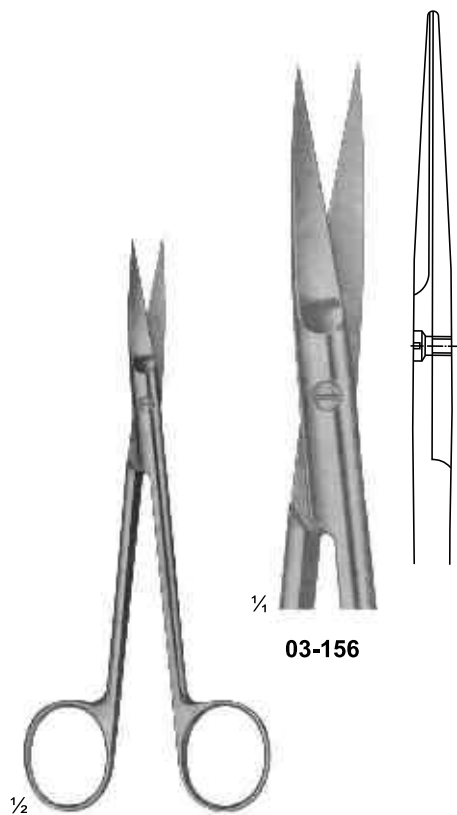

**03-156**

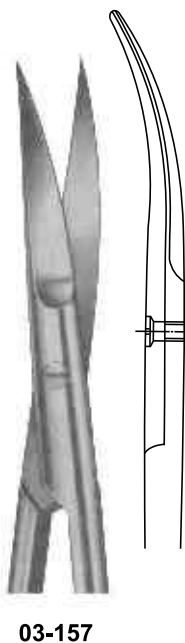

**03-157**

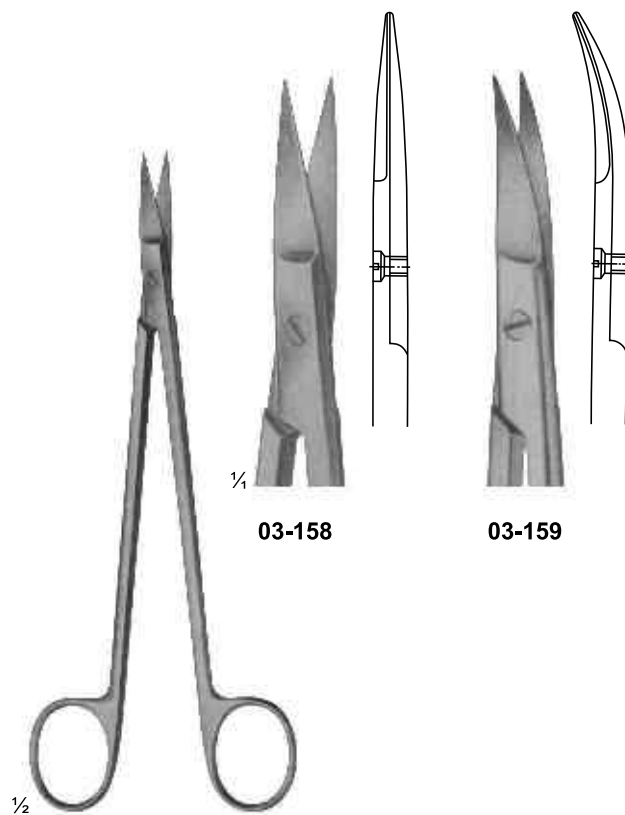

**03-158**

**03-159**

**03-156 - 157**  
JOSEPH  
Size: 150 mm

**03-158 - 159**  
KELLY  
Size: 175 mm

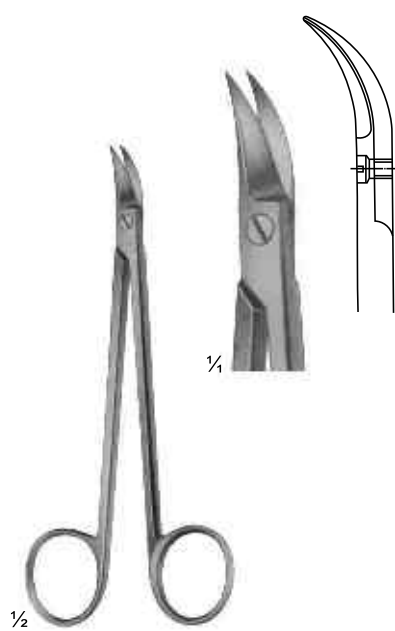

**03-160**  
QUINBY  
Size: 130 mm

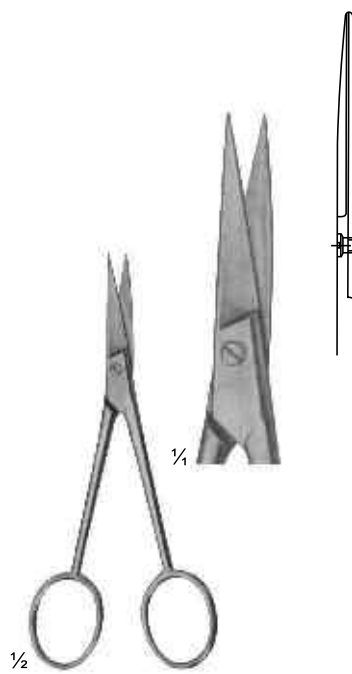

**03-161**  
Size: 110 mm

# Surgical Scissors

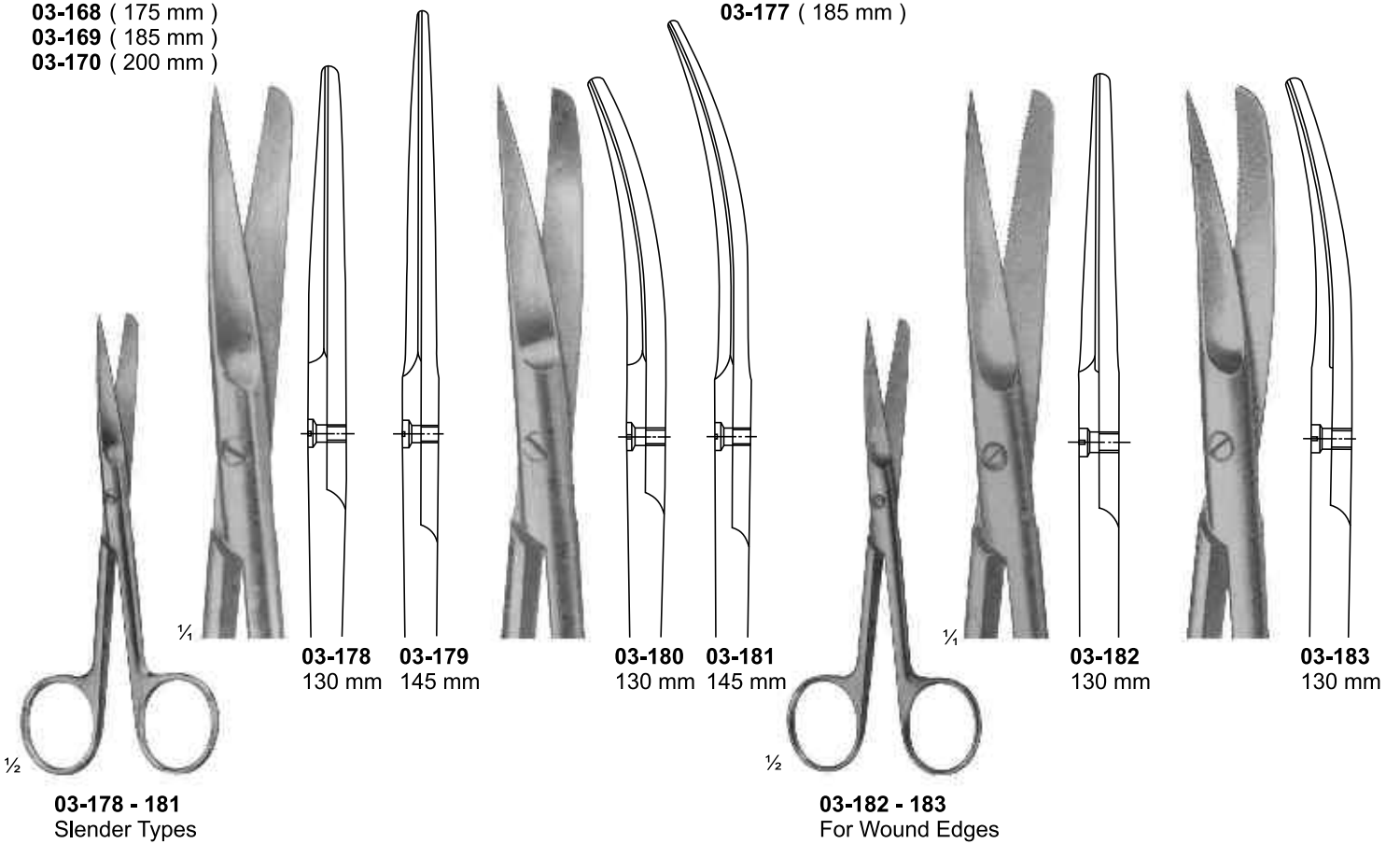
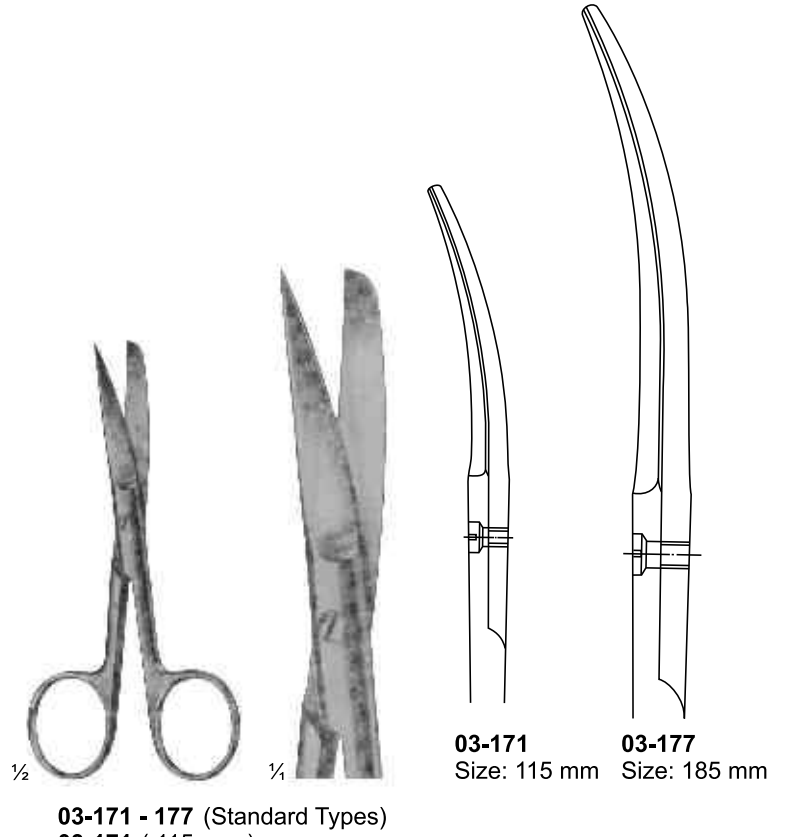
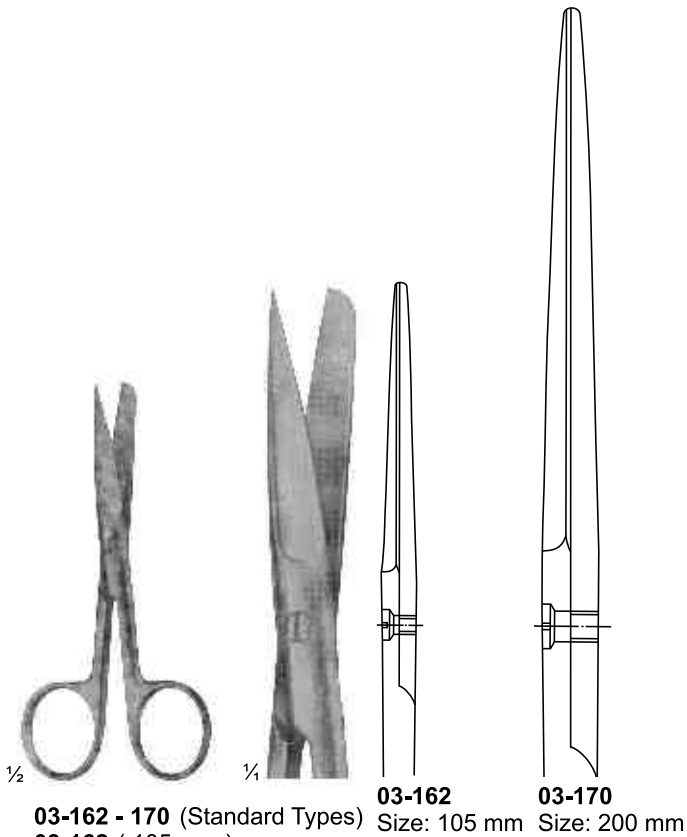

# Surgical Scissors

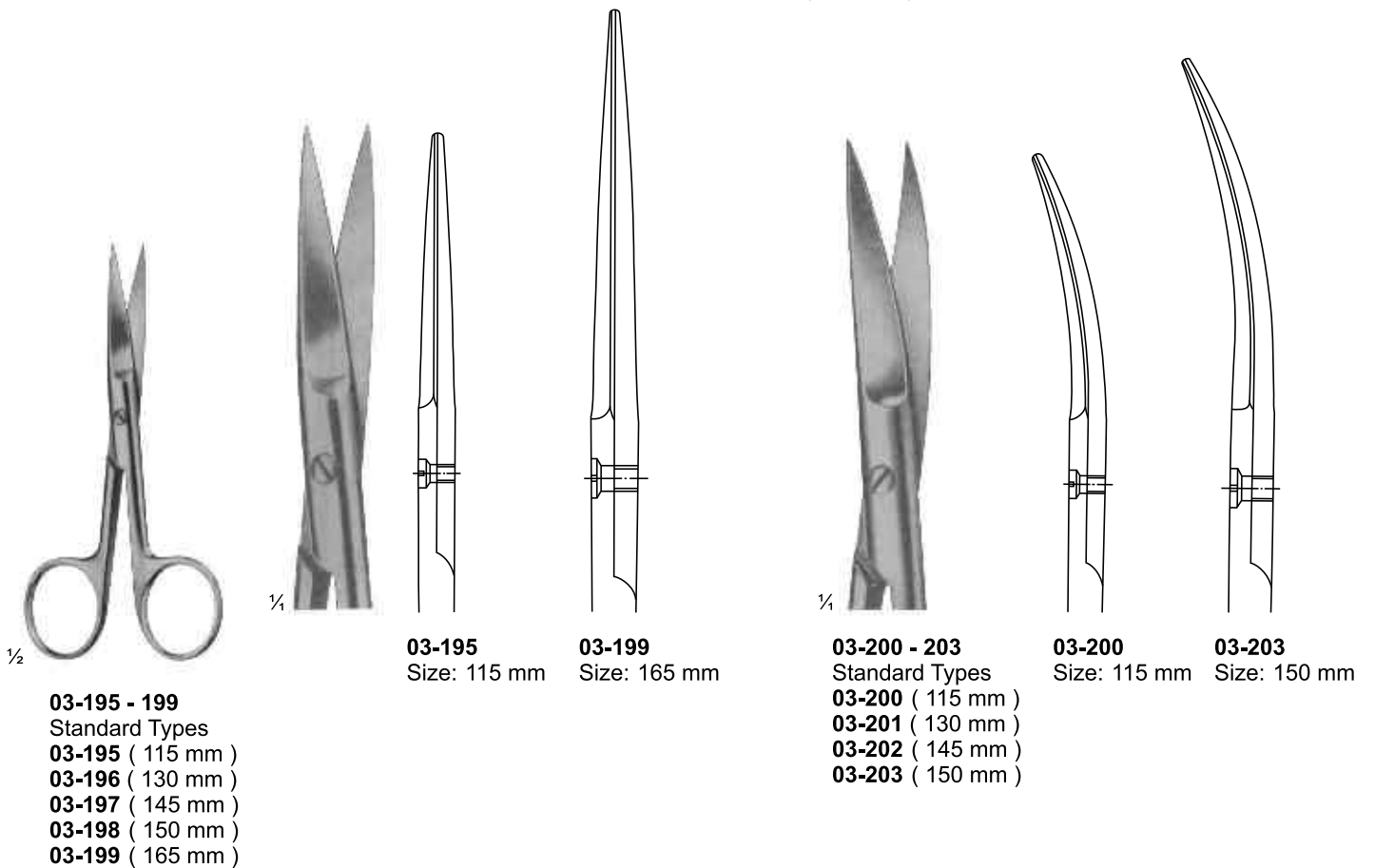
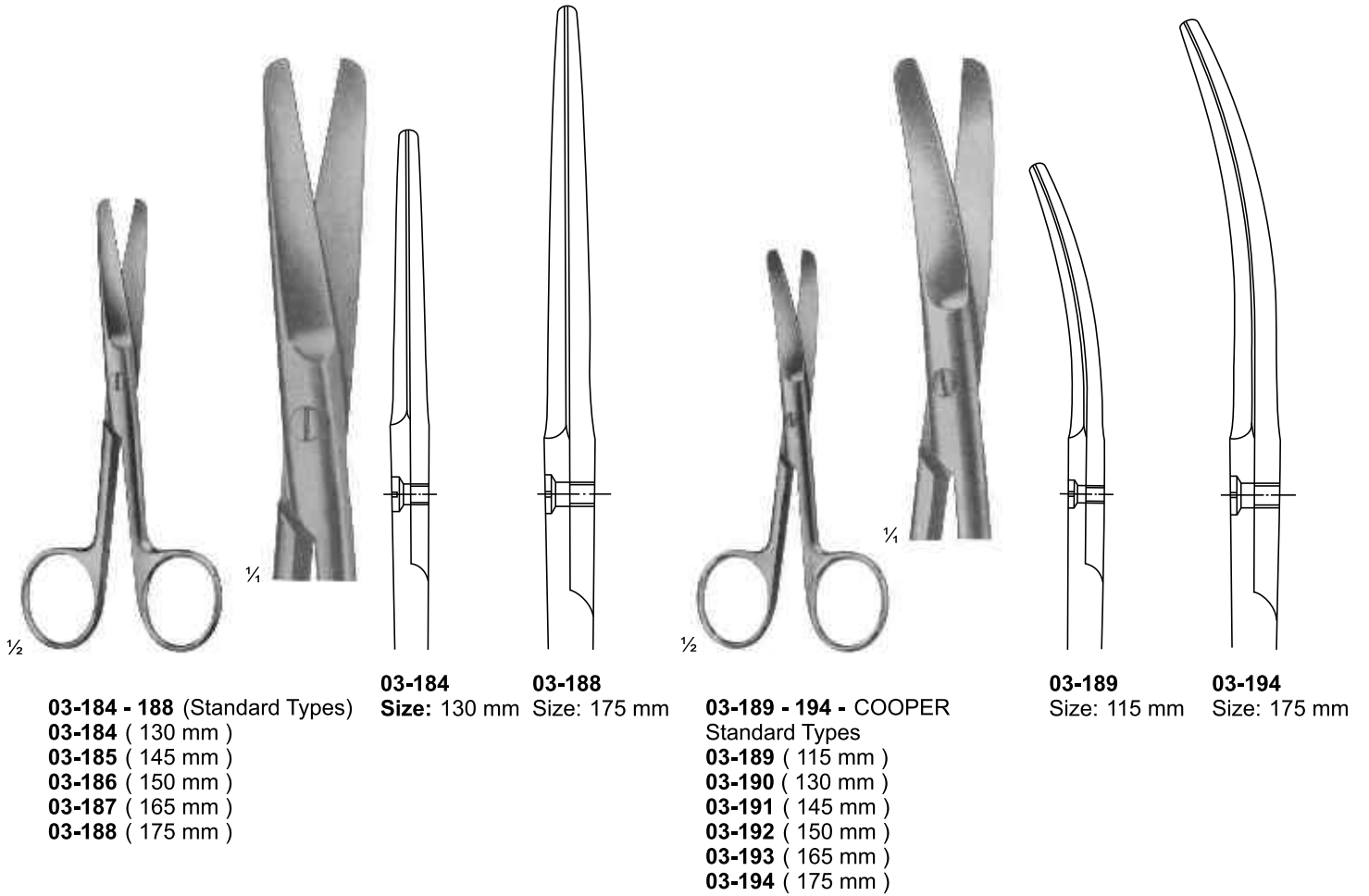

# Surgical Scissors



**03-204 - 206**  
DEAVER  
With flat lock

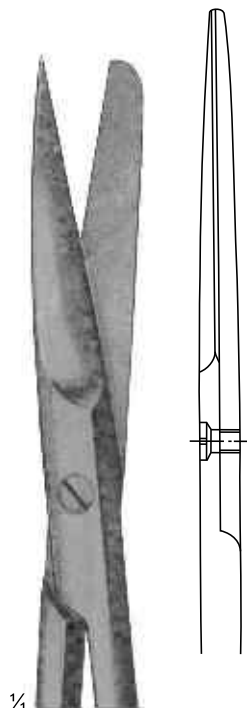

**03-204**  
Size: 145 mm

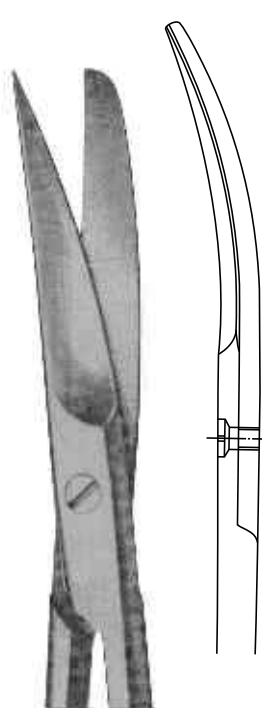

**03-205**  
Size: 145 mm

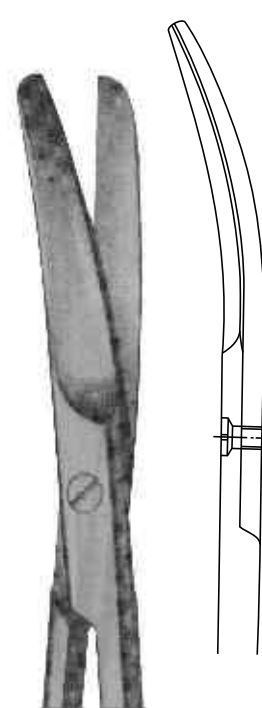

**03-206**  
Size: 145 mm



**03-207 - 209**  
Incision Scissors

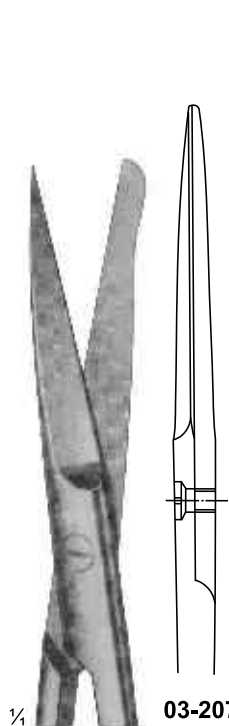

**03-207**  
Size: 130 mm

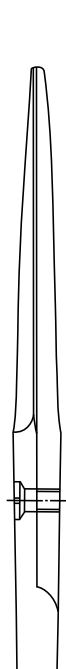

**03-208**  
Size: 145 mm

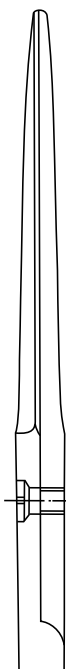

**03-209**  
Size: 165 mm



**03-210**  
SYSTRUNK  
Nail Splitting Scissors

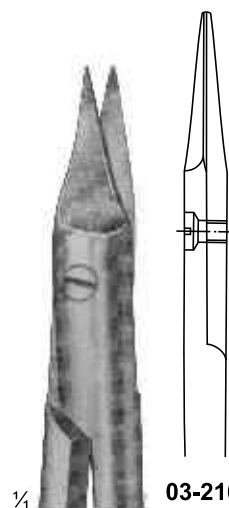

**03-210**  
Size: 130 mm



# Dissecting Scissors

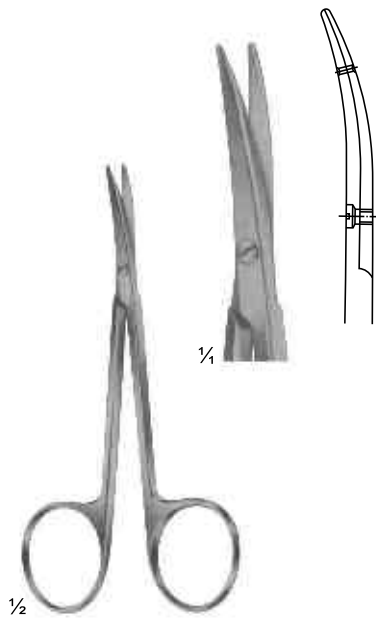

**03-211**  
LITTLER  
Dissecting Scissors  
Tips with eye for suture  
Size: 115 mm

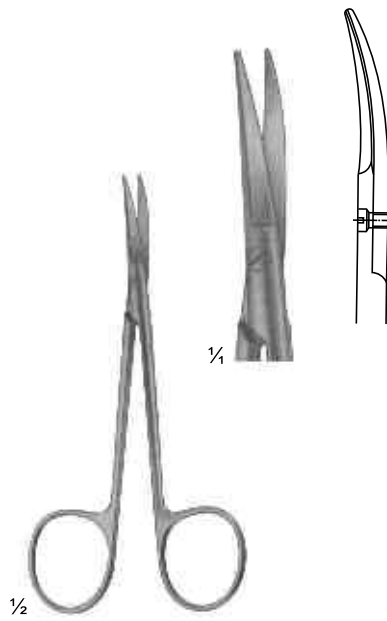

**03-212**  
COTTLE  
Bulldog Scissors  
Size: 115 mm

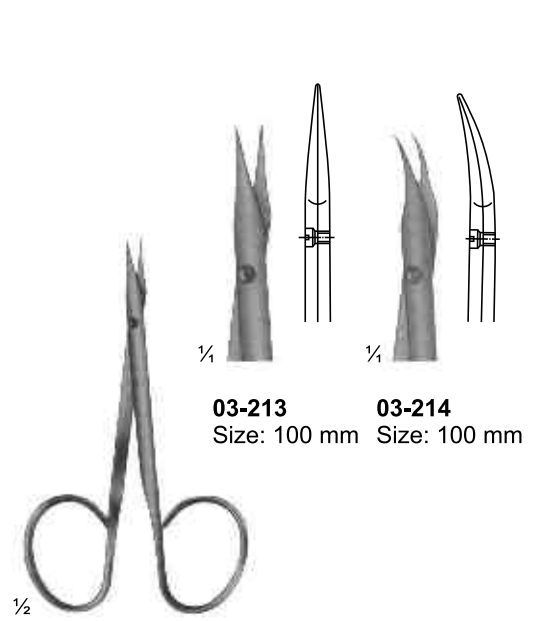

**03-213**      **03-214**  
Size: 100 mm    Size: 100 mm

**03-213 - 214**  
STEVENS  
Vessel and tendon Scissors  
Size: 100 mm

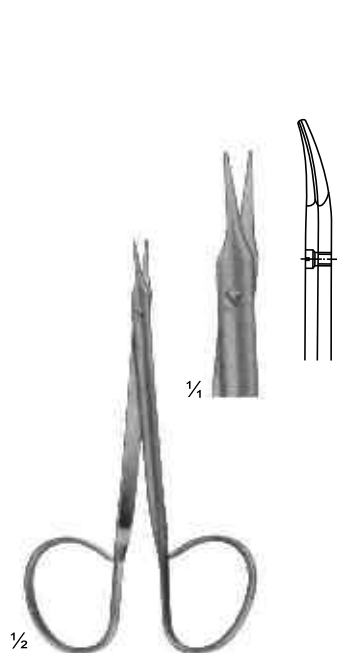

**03-215**  
STEVENS  
Fine Dissecting Scissors  
Size: 110 mm

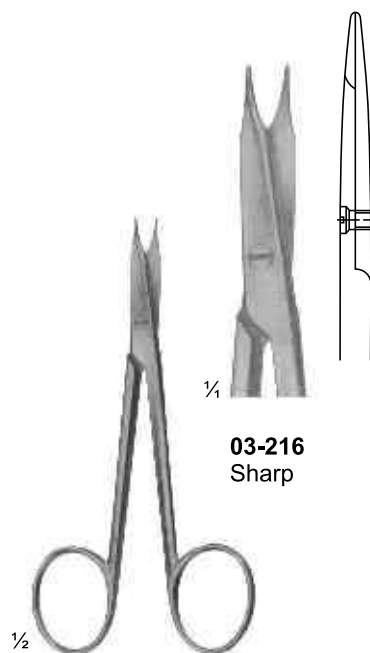

**03-216 - 219**  
STEVENS  
Vessel and tendon Scissors  
Size: 110 mm

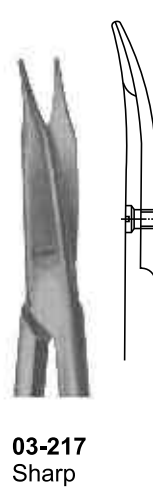

**03-217**  
Sharp

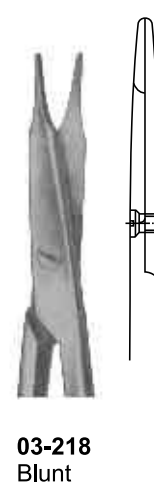

**03-218**  
Blunt

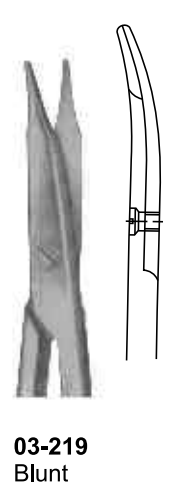

**03-219**  
Blunt

# Dissecting Scissors

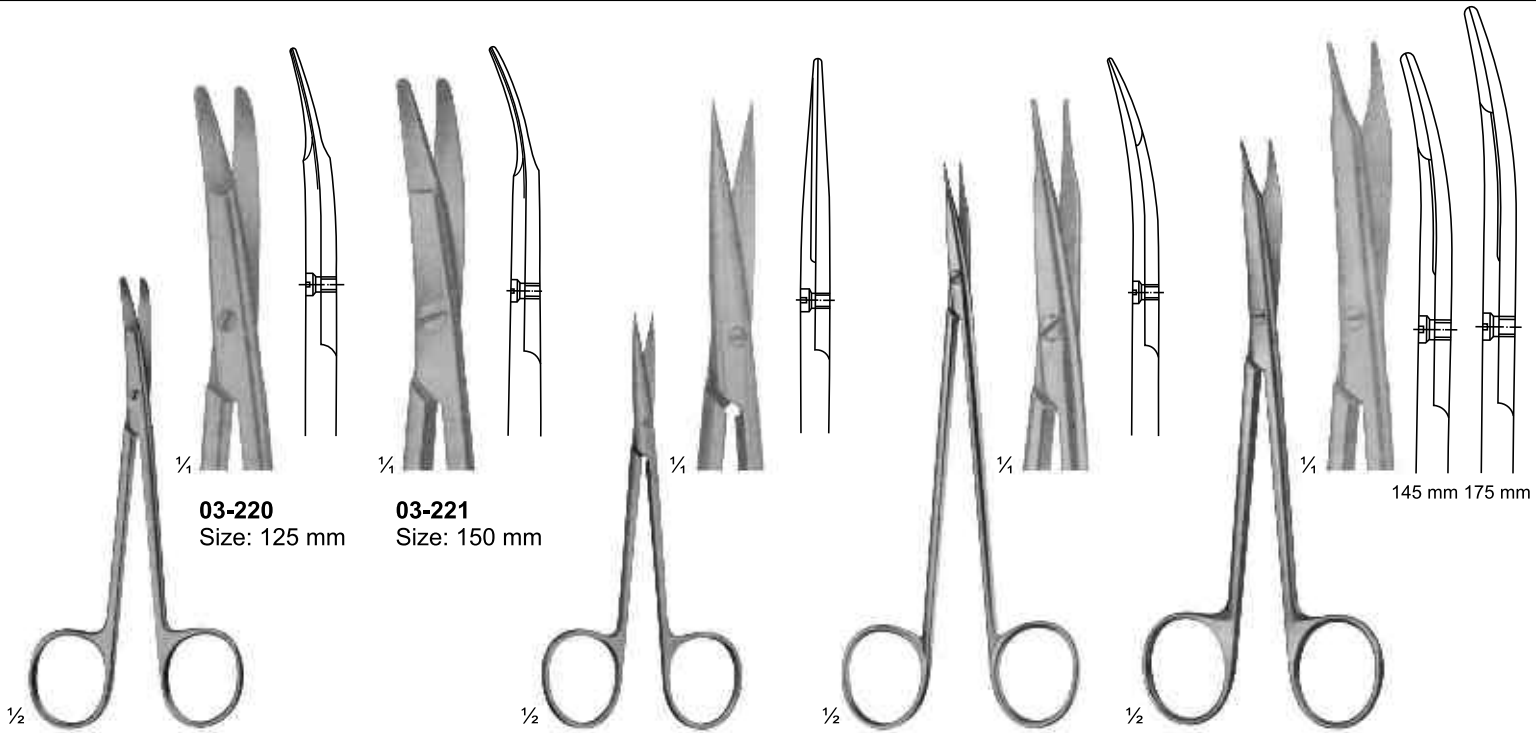

**03-220 - 221**  
KILNER  
Special flat points for dissecting  
and undermining the skin  
Size: 125 mm

**03-222**  
KILNER  
Fine dissecting scissors  
Size: 115 mm

**03-223**  
JAMESON  
Dissecting scissors  
Size: 150 mm

**03-224**  
REYNOLDS  
Dissecting scissors  
Size: 145 - 175 mm

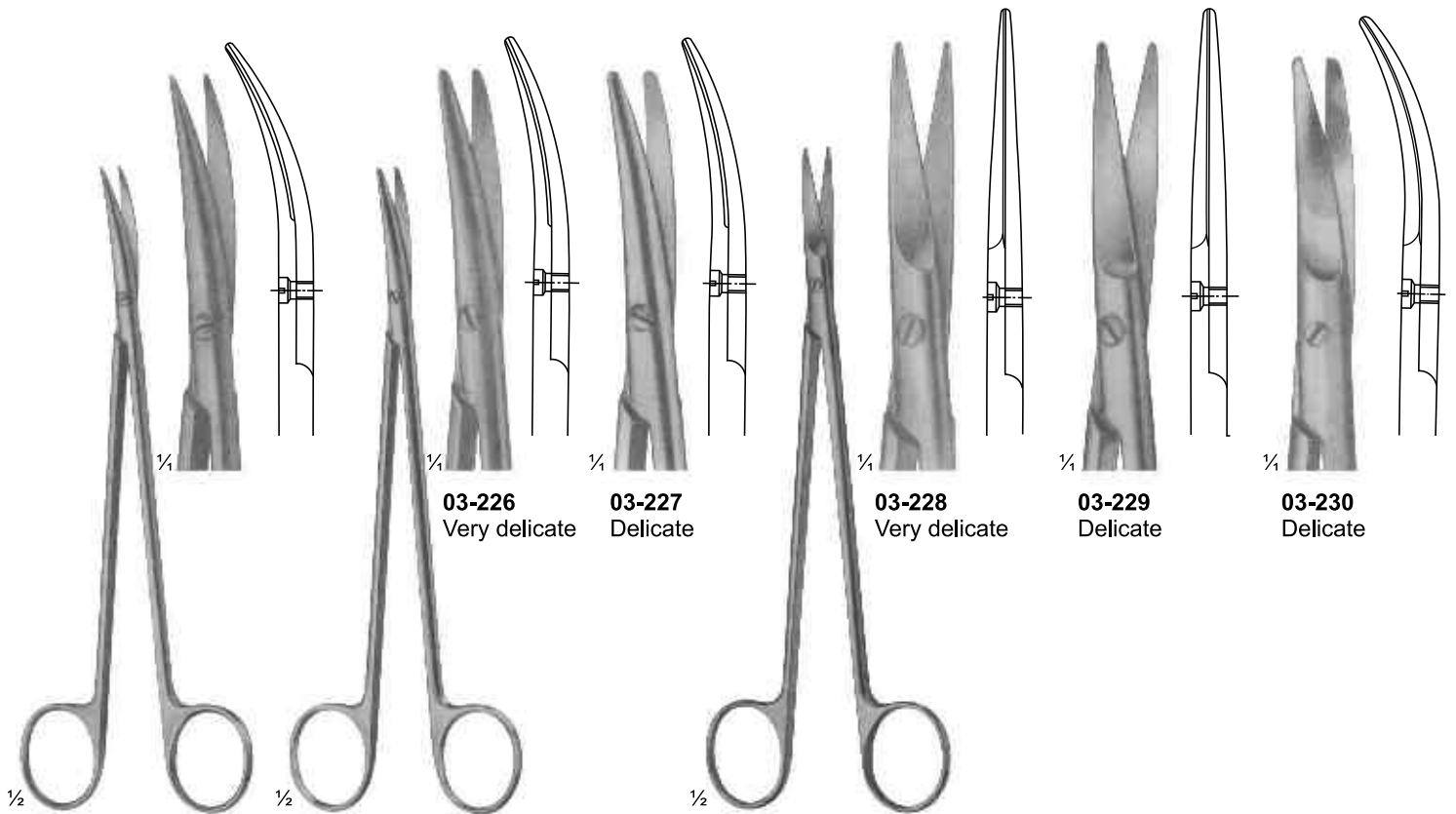

**03-225**  
DE BAKEY  
Ateriotomy scissors  
Size: 175 mm

**03-226 - 227**  
TOENNIS ADSON  
Dissecting scissors  
Size: 175 mm

**03-228 - 230**  
TOENNIS  
Dissecting scissors  
Size: 150 mm

# Dissecting & Surgical Scissors

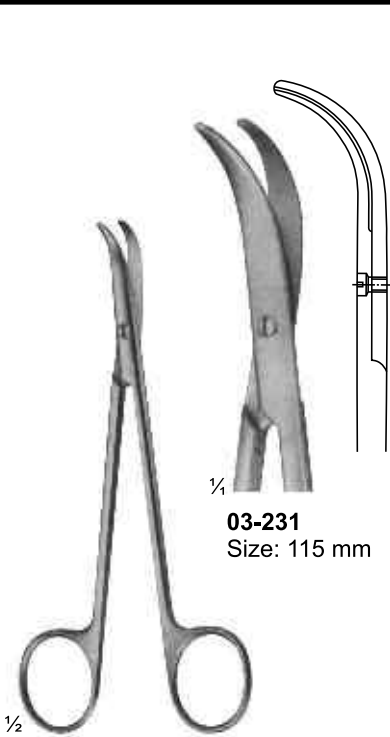

**03-231**  
Size: 115 mm

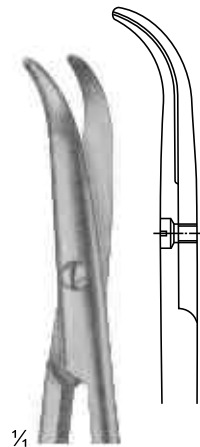

**03-232**  
Size: 135 mm

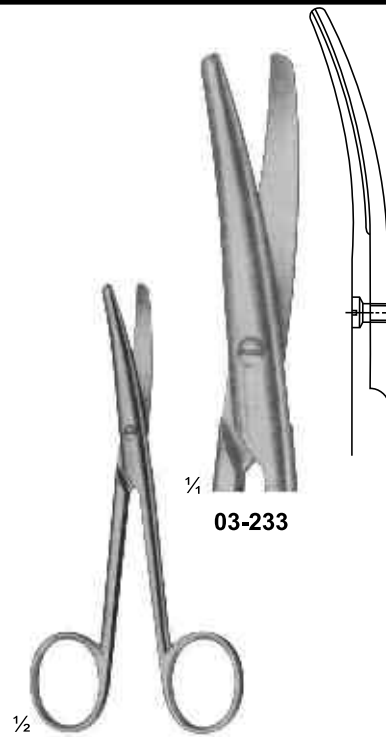

**03-233**

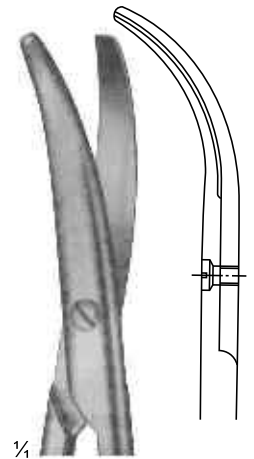

**03-234**

**03-231 - 232**  
FOMON  
Lower lateral scissors

**03-233 - 234**  
LANDOLT  
Enucleation scissors  
Size: 120 mm

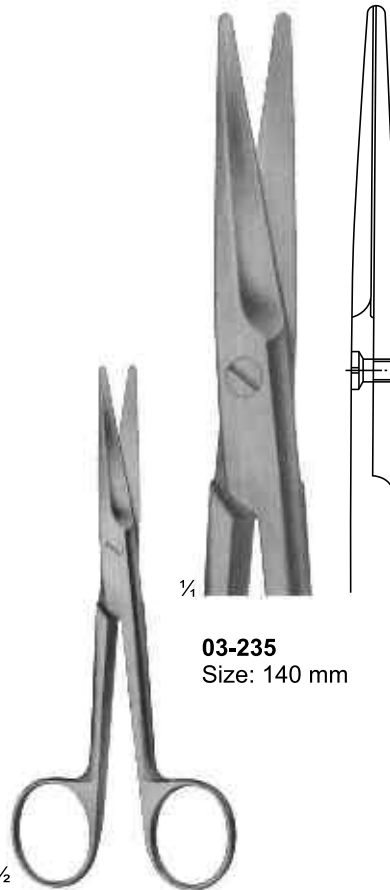

**03-235**  
Size: 140 mm

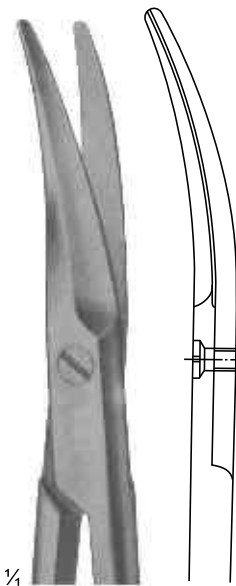

**03-238 - 240**  
MAYO  
**03-238** (140 mm)  
**03-239** (155 mm)  
**03-240** (170 mm)

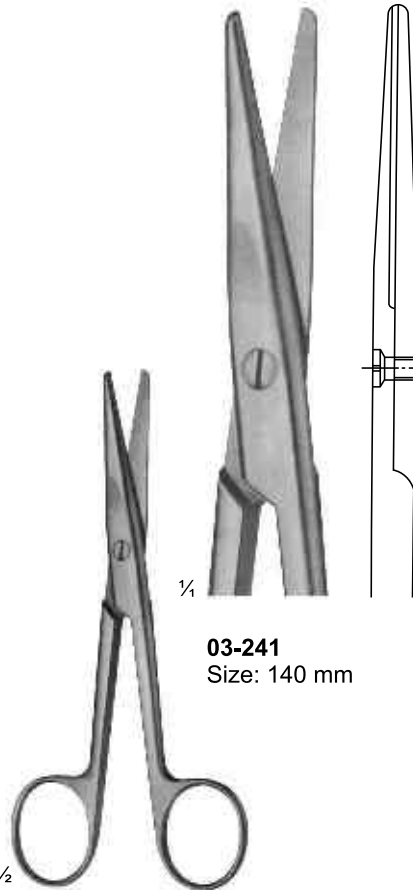

**03-241**  
Size: 140 mm

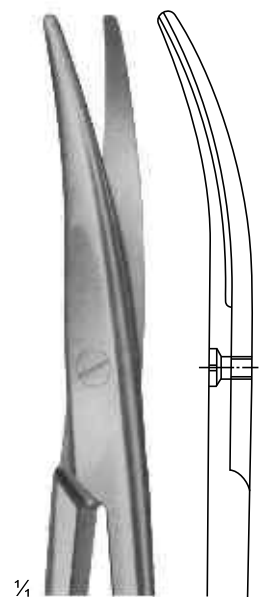

**03-243 - 244**  
MAYO-STILLE  
**03-243** (140 mm)  
**03-244** (170 mm)

**03-235 - 237**  
MAYO  
**03-235** (140 mm)  
**03-236** (155 mm)  
**03-237** (170 mm)

**03-241 - 242**  
MAYO-STILLE  
**03-241** (140 mm)  
**03-242** (170 mm)

# Dissecting Scissors

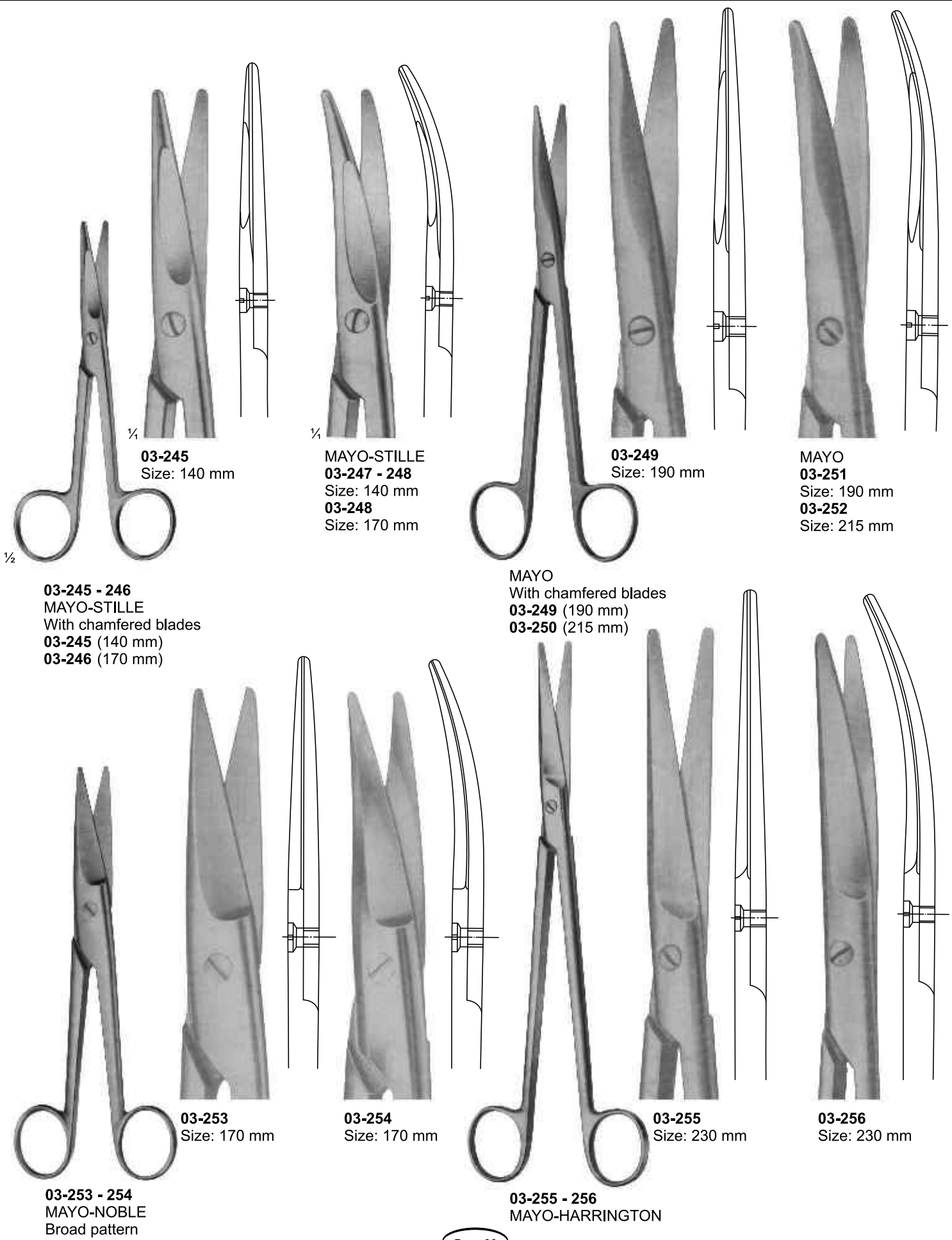

**03-245**  
Size: 140 mm

**MAYO-STILLE**  
**03-247 - 248**  
Size: 140 mm  
**03-248**  
Size: 170 mm

**03-249**  
Size: 190 mm

**MAYO**  
**03-251**  
Size: 190 mm  
**03-252**  
Size: 215 mm

**03-245 - 246**  
**MAYO-STILLE**  
With chamfered blades  
**03-245** (140 mm)  
**03-246** (170 mm)

**MAYO**  
With chamfered blades  
**03-249** (190 mm)  
**03-250** (215 mm)

**03-253**  
Size: 170 mm

**03-254**  
Size: 170 mm

**03-255**  
Size: 230 mm

**03-256**  
Size: 230 mm

**03-253 - 254**  
**MAYO-STILLE**  
Broad pattern

**03-255 - 256**  
**MAYO-HARRINGTON**

# Dissecting Scissors

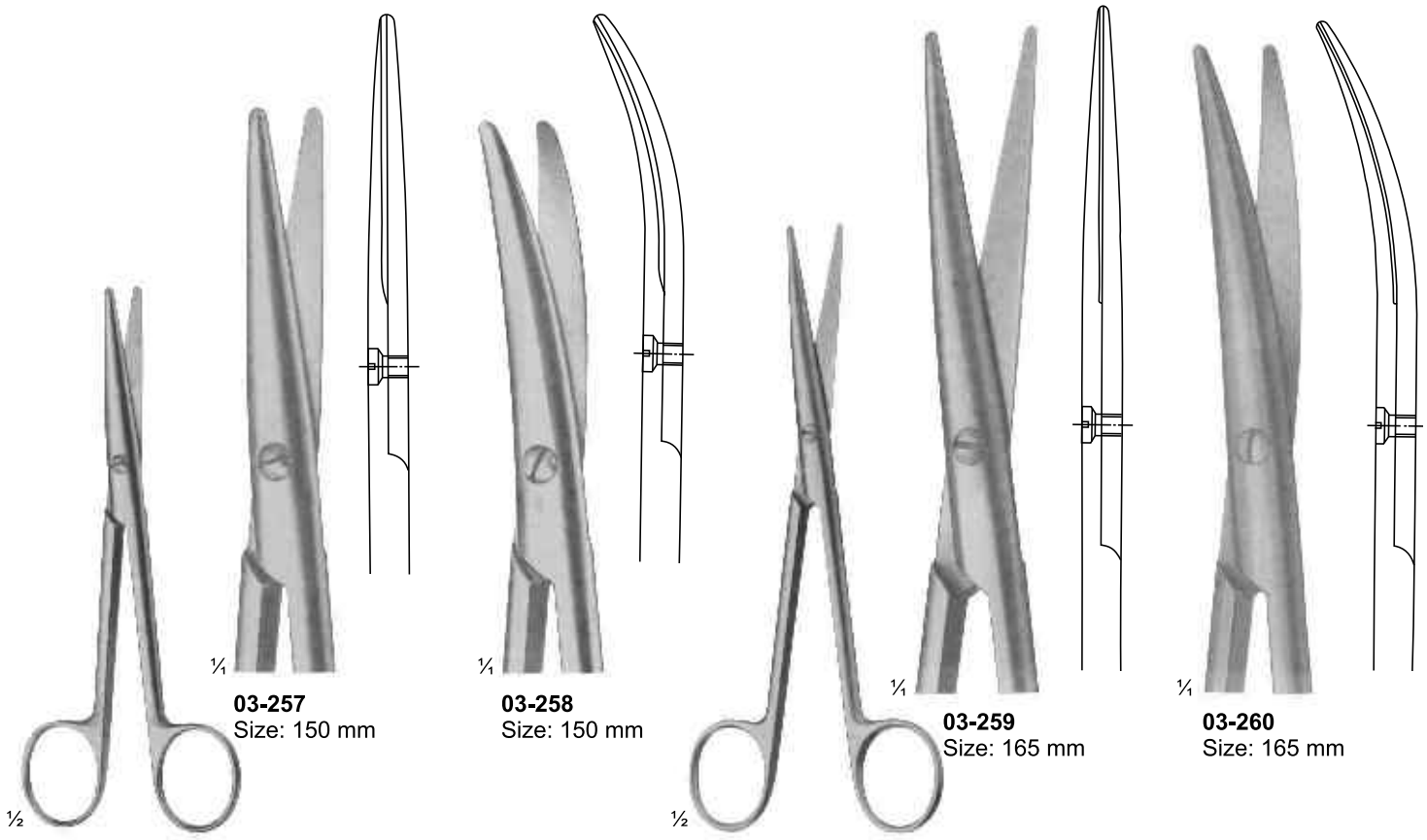

**03-257**  
Size: 150 mm

**03-258**  
Size: 150 mm

**03-259**  
Size: 165 mm

**03-260**  
Size: 165 mm

**03-257 - 258**  
STILLE  
Size: 150 mm

**03-259 - 260**  
LEXER  
Narrow  
Size: 165 mm

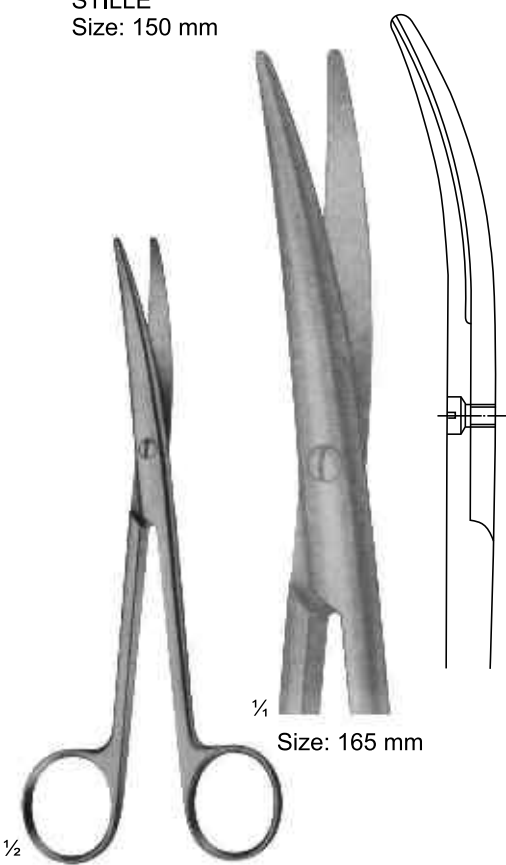

Size: 165 mm

**03-262**  
Size: 165 mm

**MAYO**  
**03-264 - 266**  
Size: 165 mm

**03-261**  
MAYO-LEXER  
Standard

**03-262 - 263**  
MAYO  
**03-262** (165 mm)  
**03-263** (200 mm)

**03-265**  
Size: 200 mm  
**03-266**  
Size: 210 mm

# Dissecting Scissors

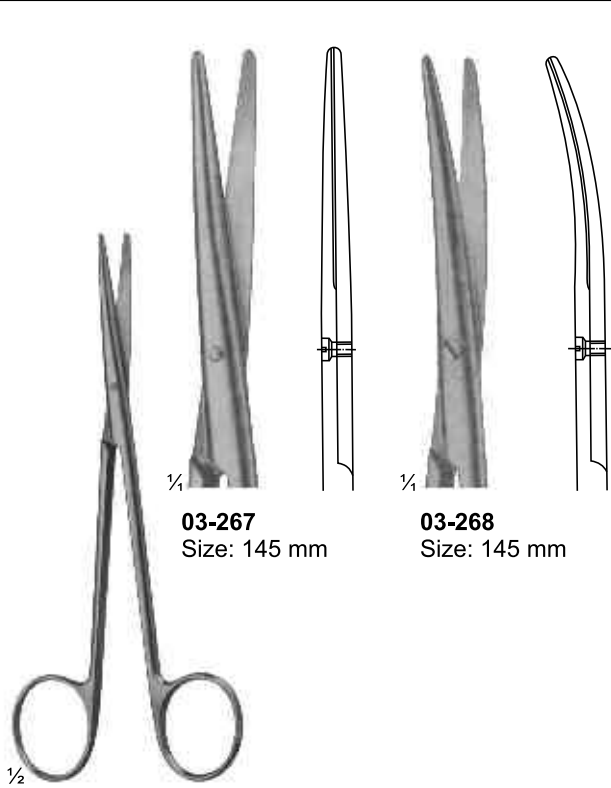

**03-267**  
Size: 145 mm

**03-268**  
Size: 145 mm

**03-267 - 268**  
BABY - METZENBAUM

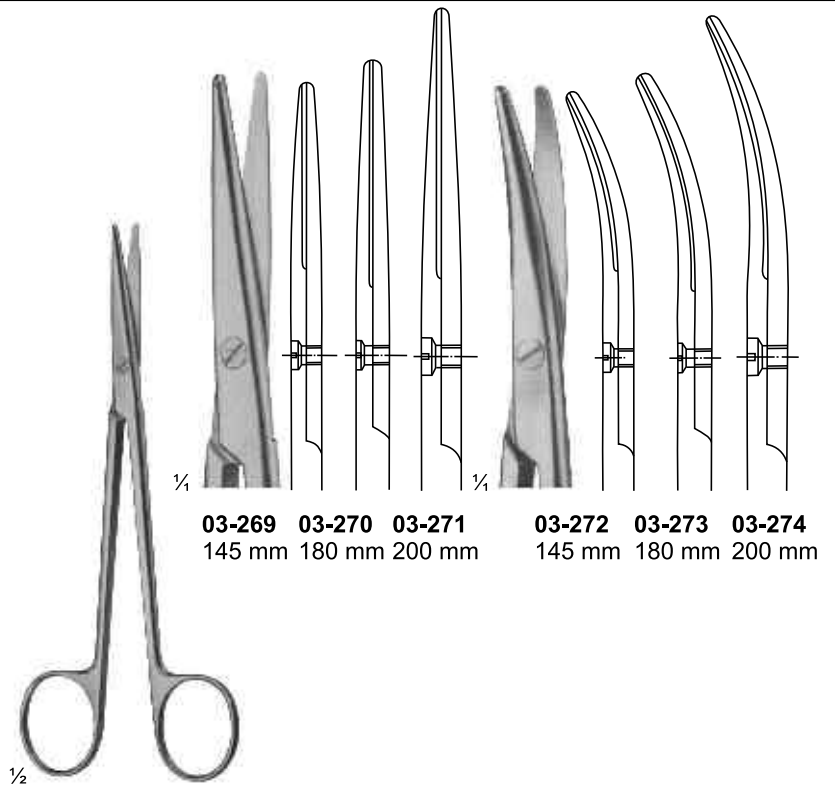

**03-269** **03-270** **03-271**  
145 mm 180 mm 200 mm

**03-272** **03-273** **03-274**  
145 mm 180 mm 200 mm

**03-269 - 274**  
METZENBAUM

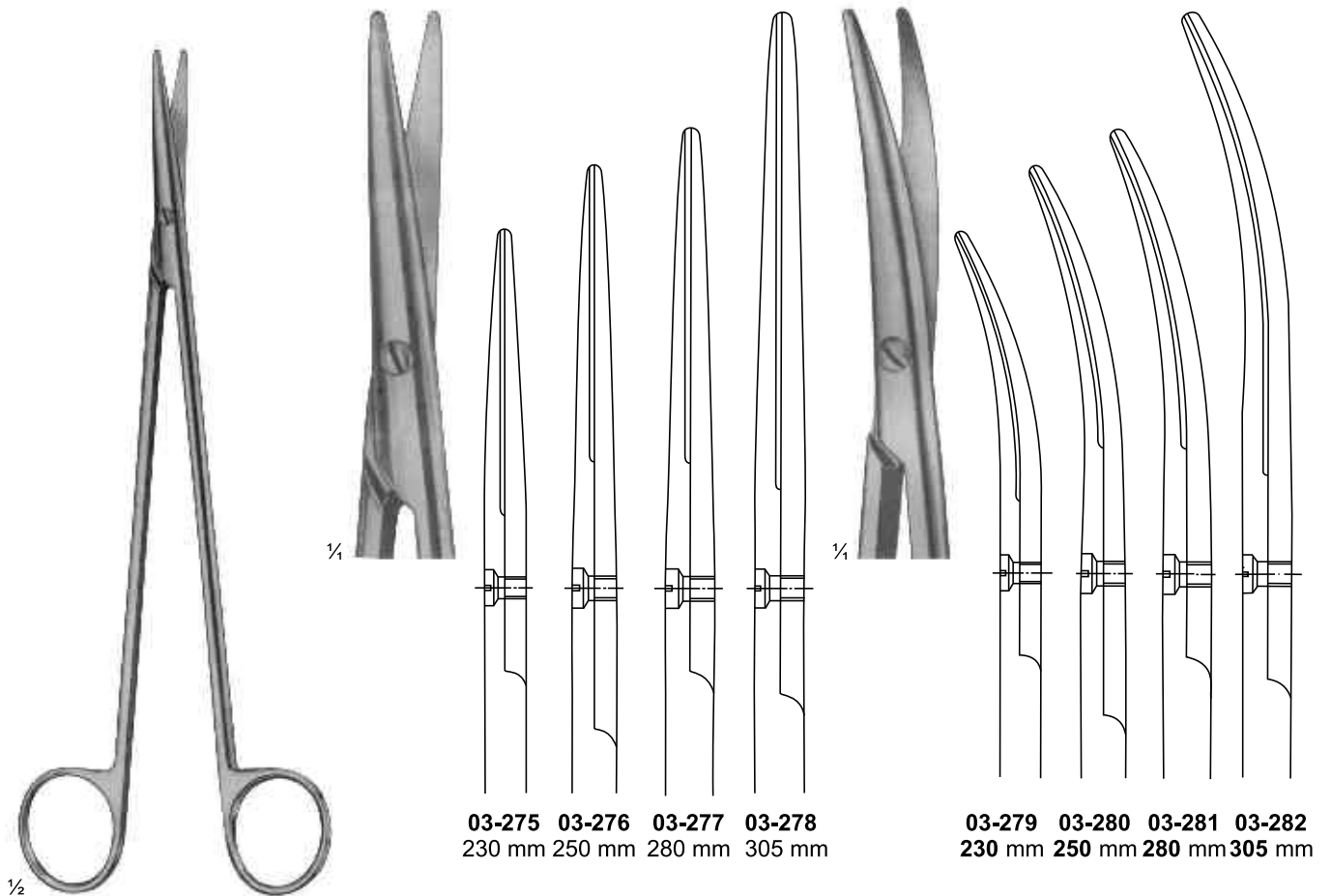

**03-275** **03-276** **03-277** **03-278**  
230 mm 250 mm 280 mm 305 mm

**03-279** **03-280** **03-281** **03-282**  
230 mm 250 mm 280 mm 305 mm

**03-275 - 282**  
NELSON - METZENBAUM

# Vessel Scissors

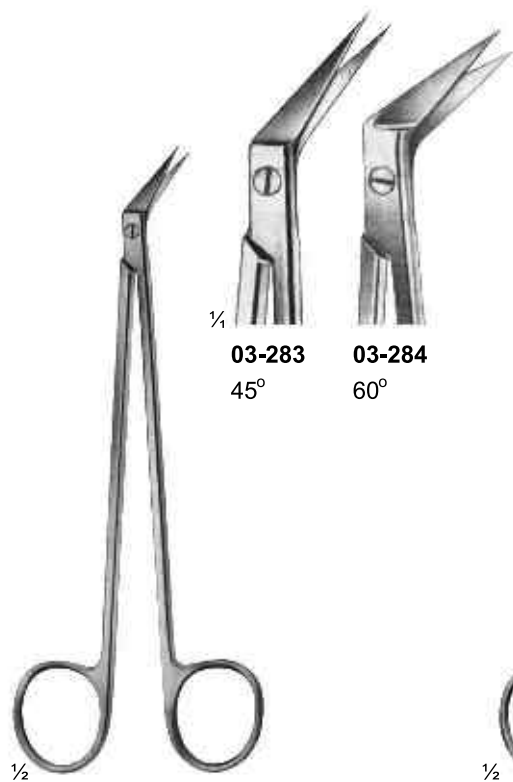

**03-283**  
45°

**03-284**  
60°

**03-283 - 284**  
DE BAKEY  
Size: 155 mm

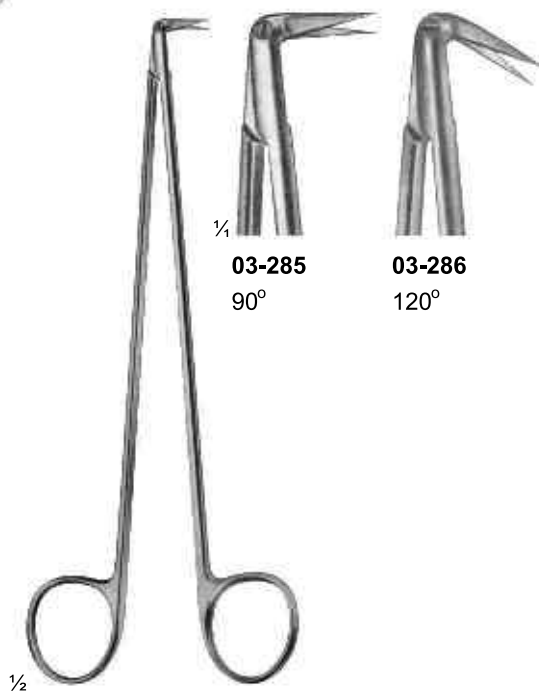

**03-285**  
90°

**03-286**  
120°

**03-285 - 286**  
DIETRICH  
Size: 170 mm

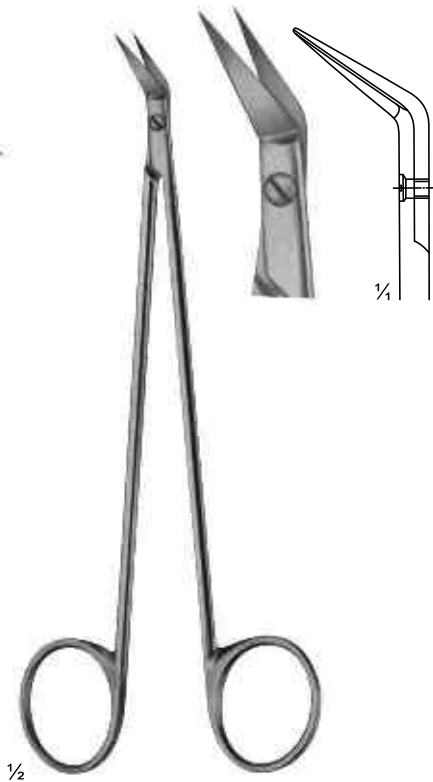

**03-287**  
POTTS-SMITH  
Size: 180 mm



**03-288**  
60°

**03-288**  
POTTS-SMITH  
Size: 180 mm

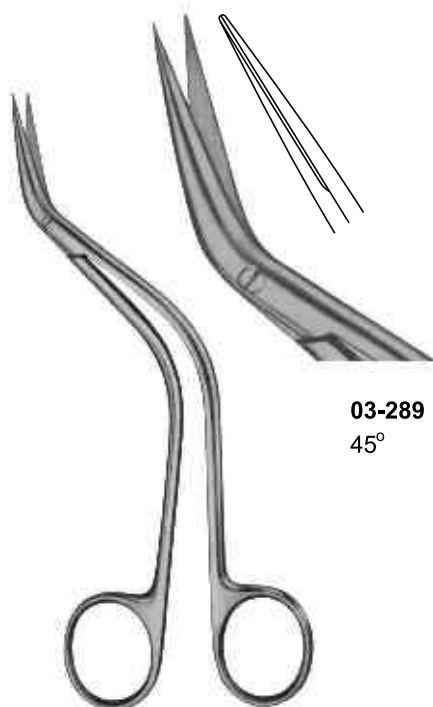

**03-289**  
45°

**03-289**  
DEBAKEY  
Size: 155 mm

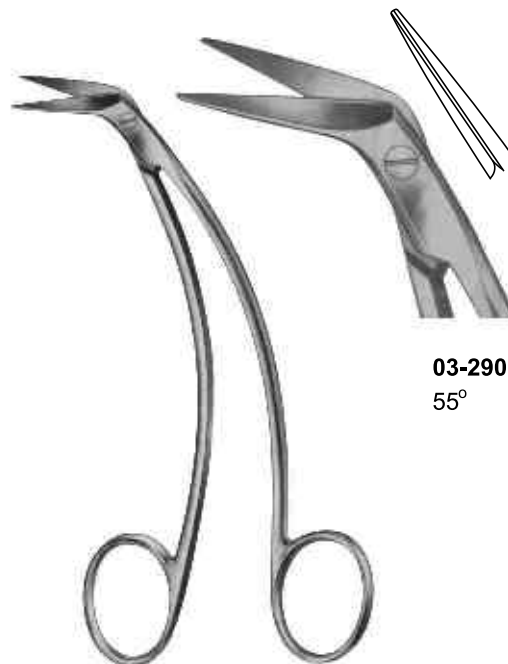

**03-290**  
55°

**03-290**  
FAVOLORO  
Size: 140 mm



# Cardiovascular and Neuro-Surgery Scissors



**03-291**  
OLIVECRONA  
Dura Scissors

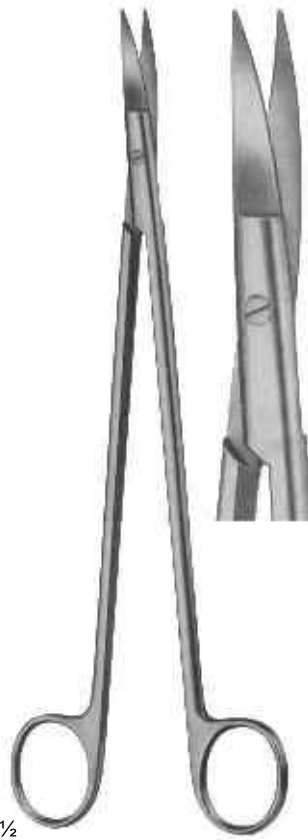

**03-292**  
STRULLY  
Pointed  
Size: 220 mm

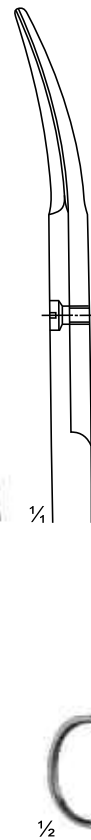

**03-293**  
STRULLY  
Probe Pointed  
Size: 220 mm

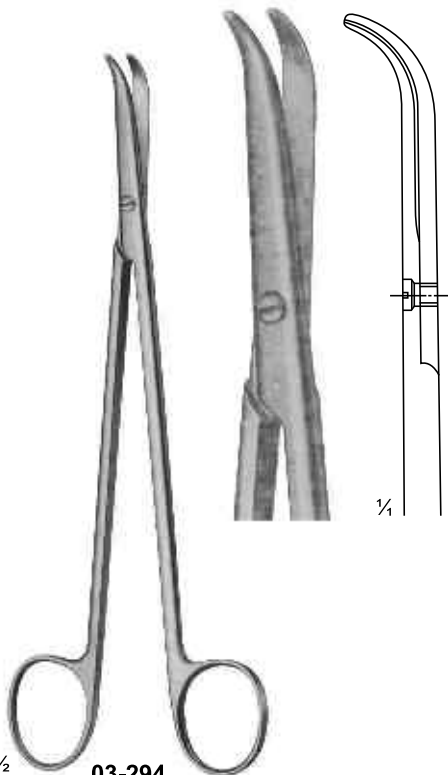
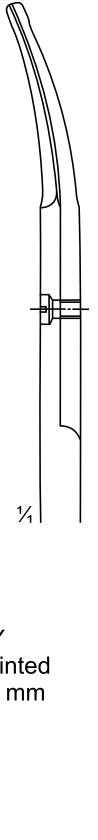

**03-294**  
THOREK  
Size: 180 mm

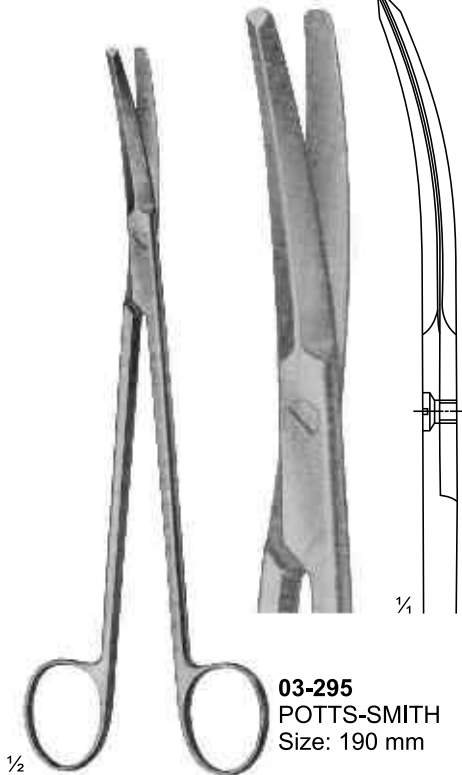
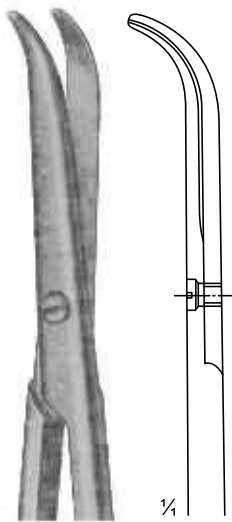

**03-295**  
POTTS-SMITH  
Size: 190 mm

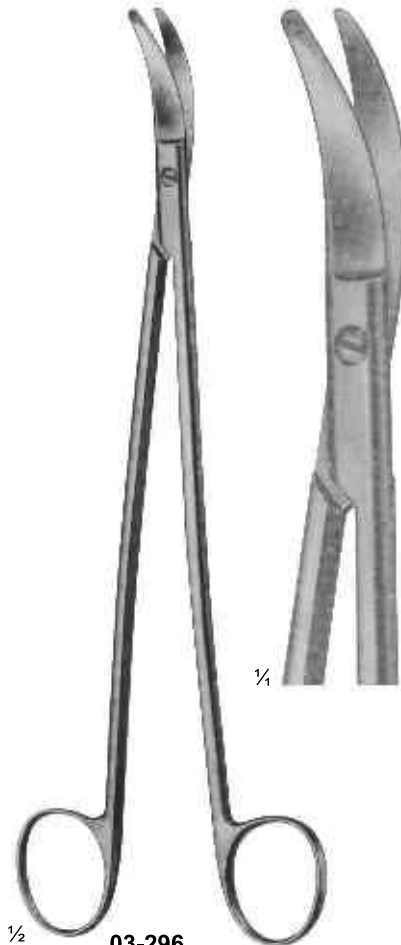
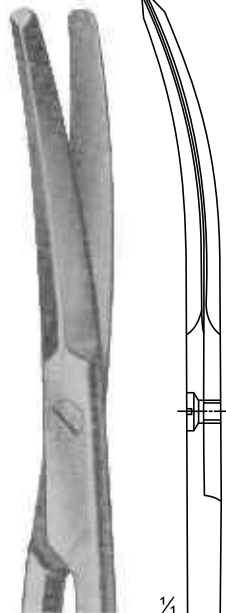

**03-296**  
SATINSKY  
Size: 245 mm

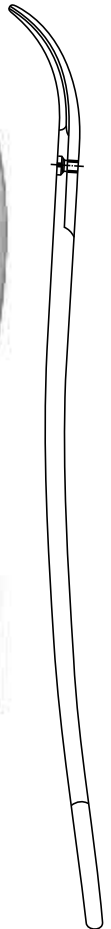

# Delicate, Nasal and Tonsil Scissors

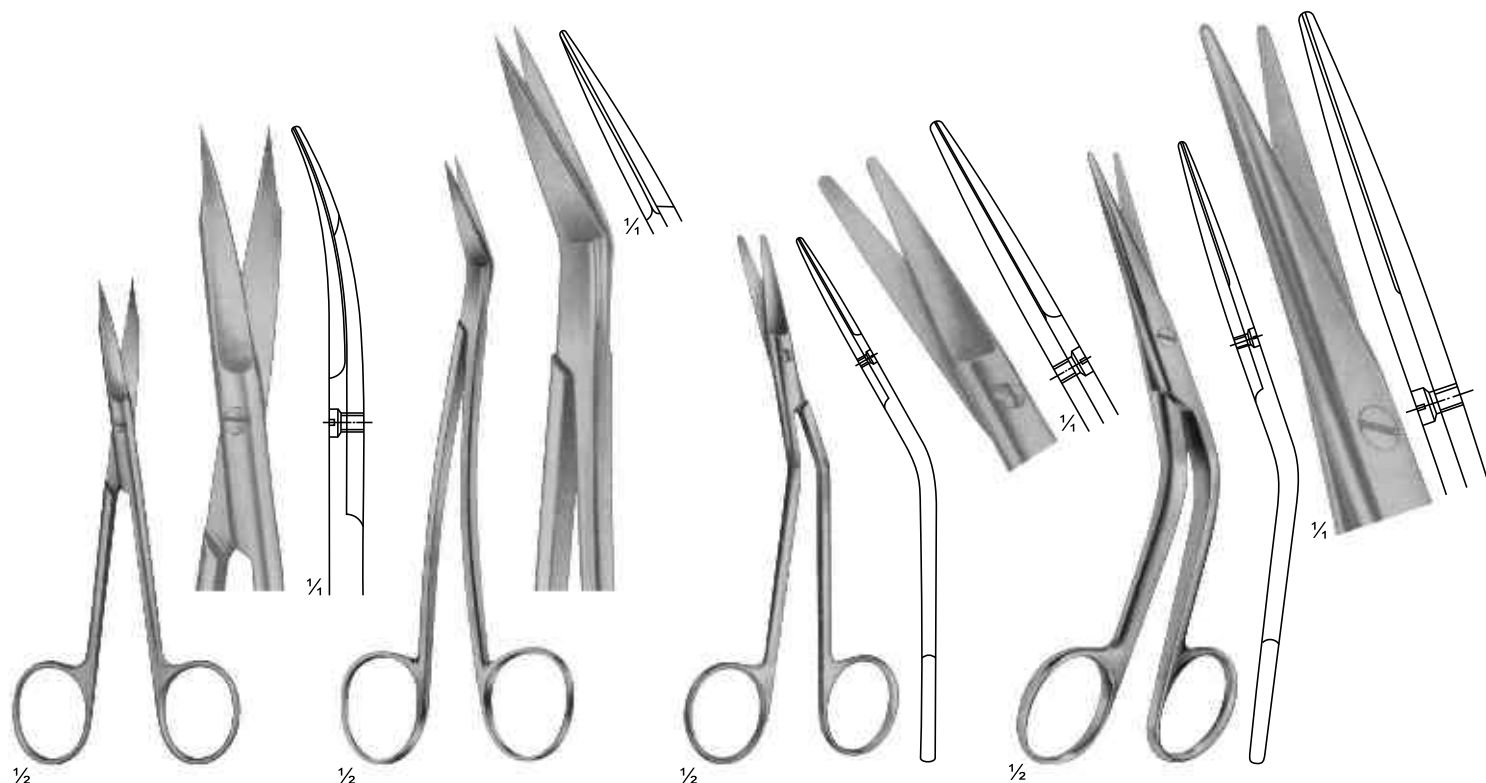

**03-297**  
1 Finely Toothed Blade  
Size: 130 mm

**03-298**  
LOCKLIN  
Curved Sideways,  
1 Toothed Blade  
Size: 155 mm

**03-299**  
FOMON  
Blades Serrated  
Size: 145 mm

**03-300**  
COTTLE  
Size: 165 mm

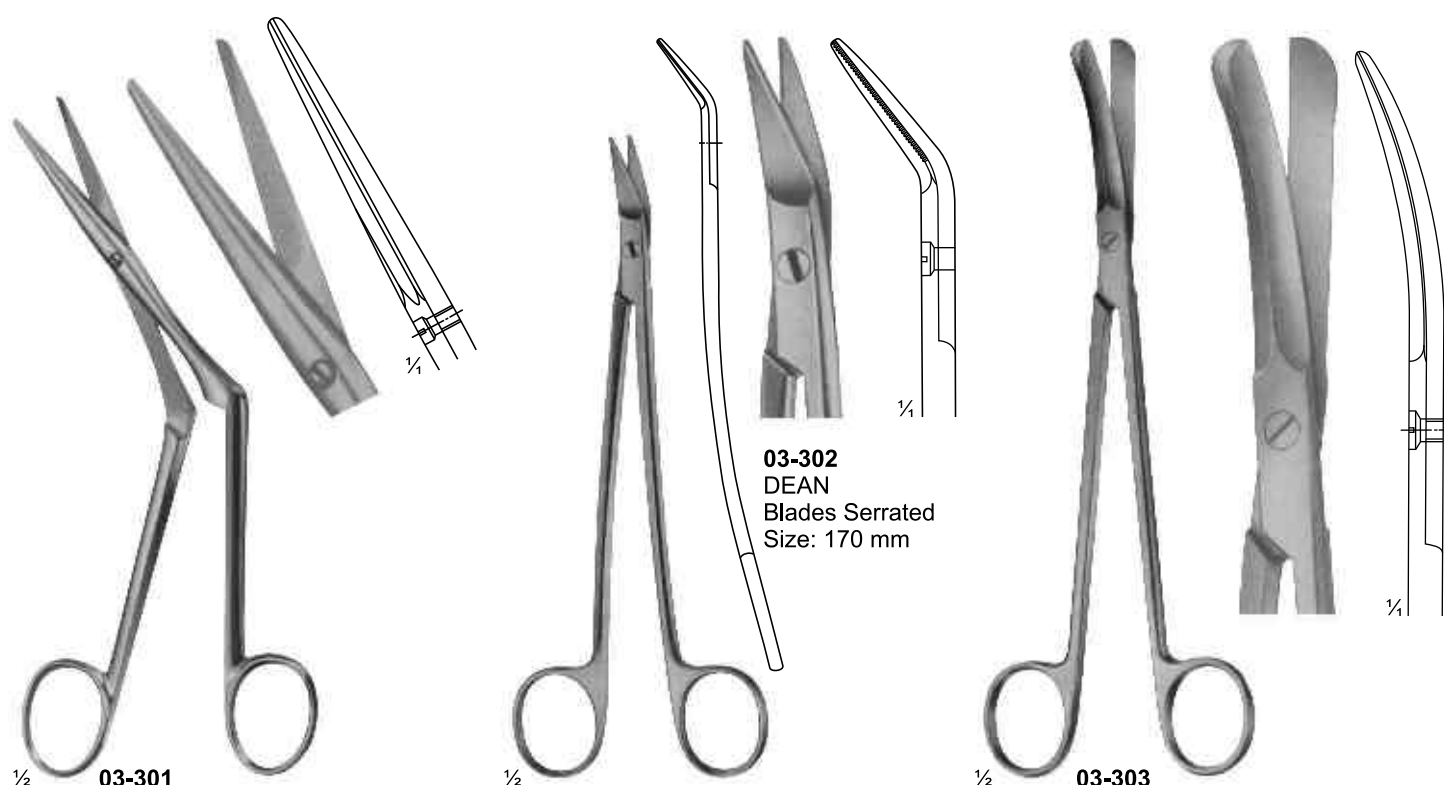

**03-301**  
HEYMANN-KNIGHT  
Size: 175 mm

**03-302**  
DEAN  
Blades Serrated  
Size: 170 mm

**03-303**  
GOOD  
Size: 195 mm

# Bone Shears

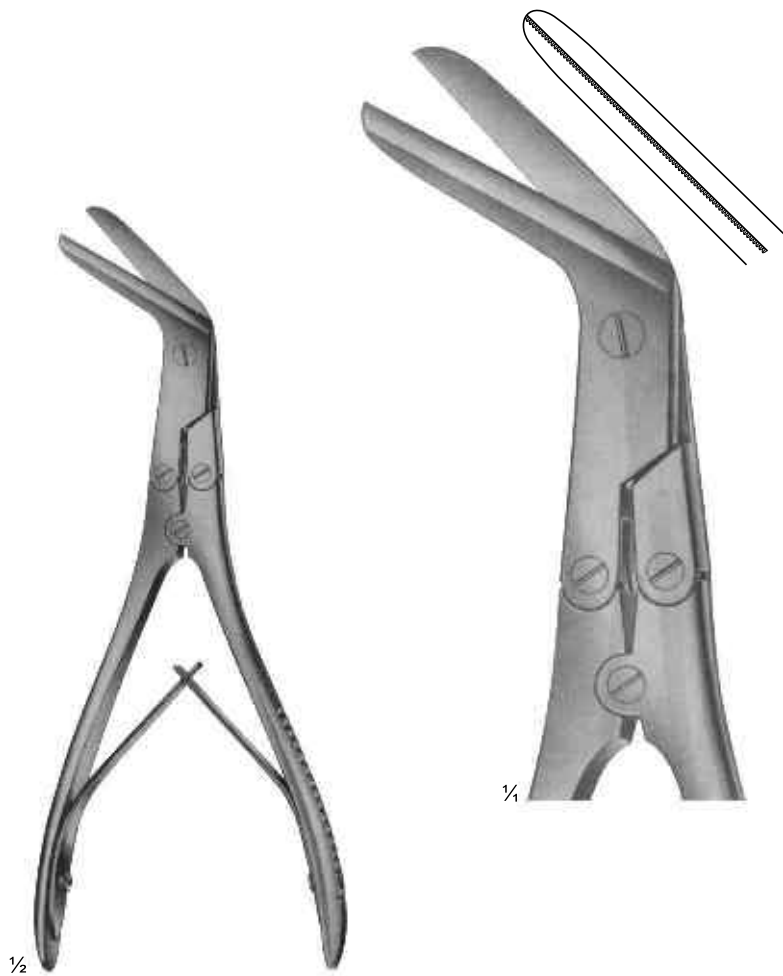

**03-304**  
KILLIAN  
Size: 200 mm



**03-305 - 306**



**03-305**  
195 mm

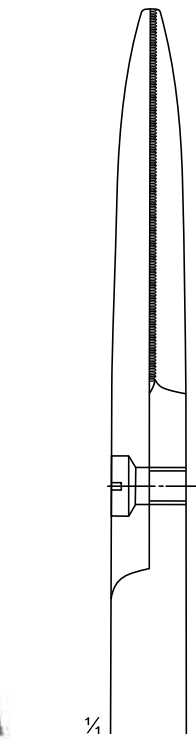

**03-306**  
225 mm

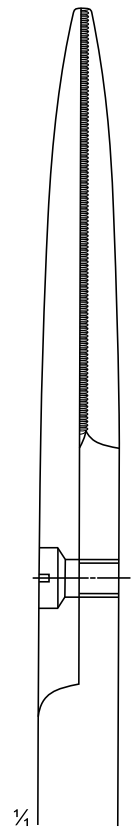

# Operating and Gynaecology Scissors

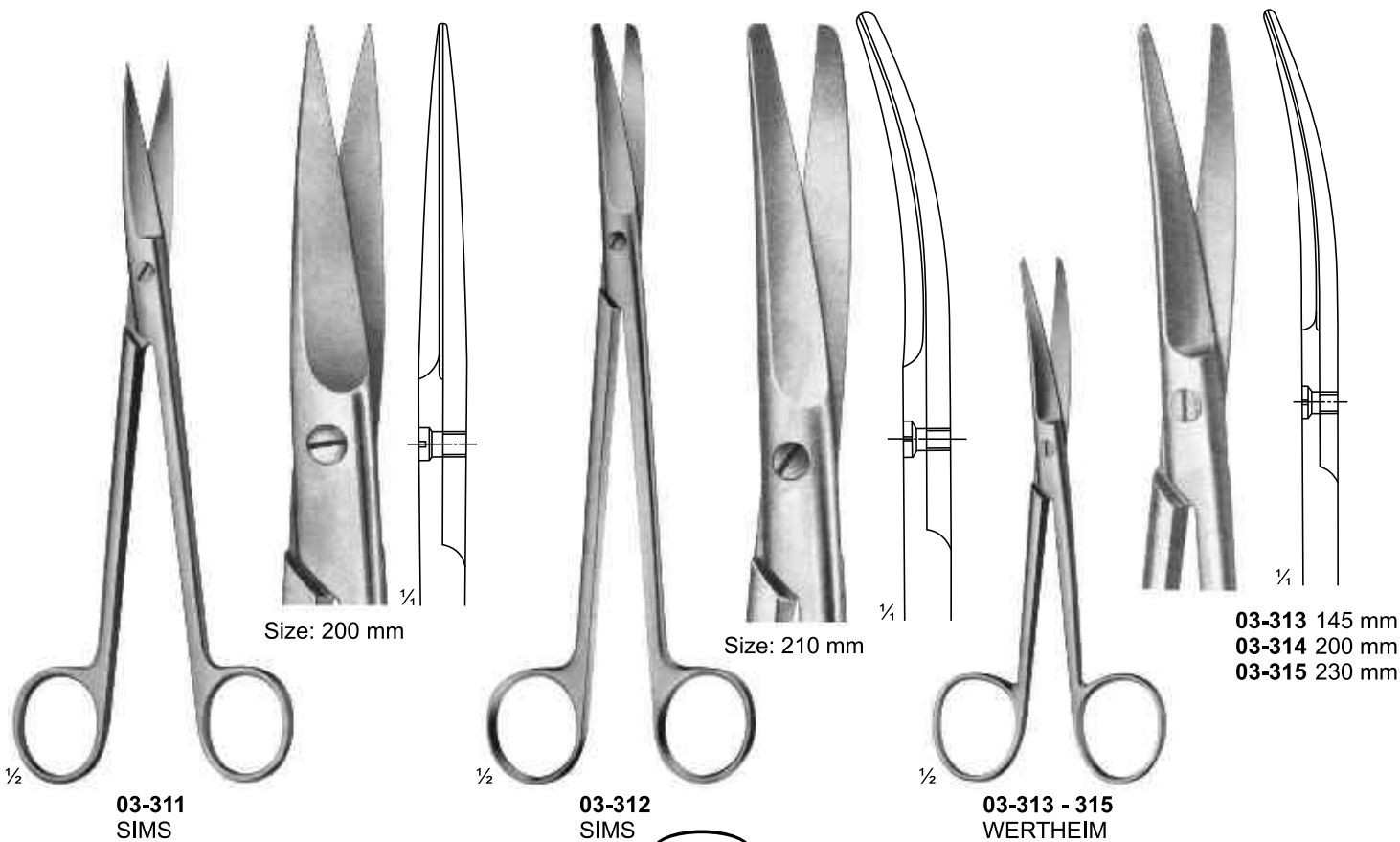
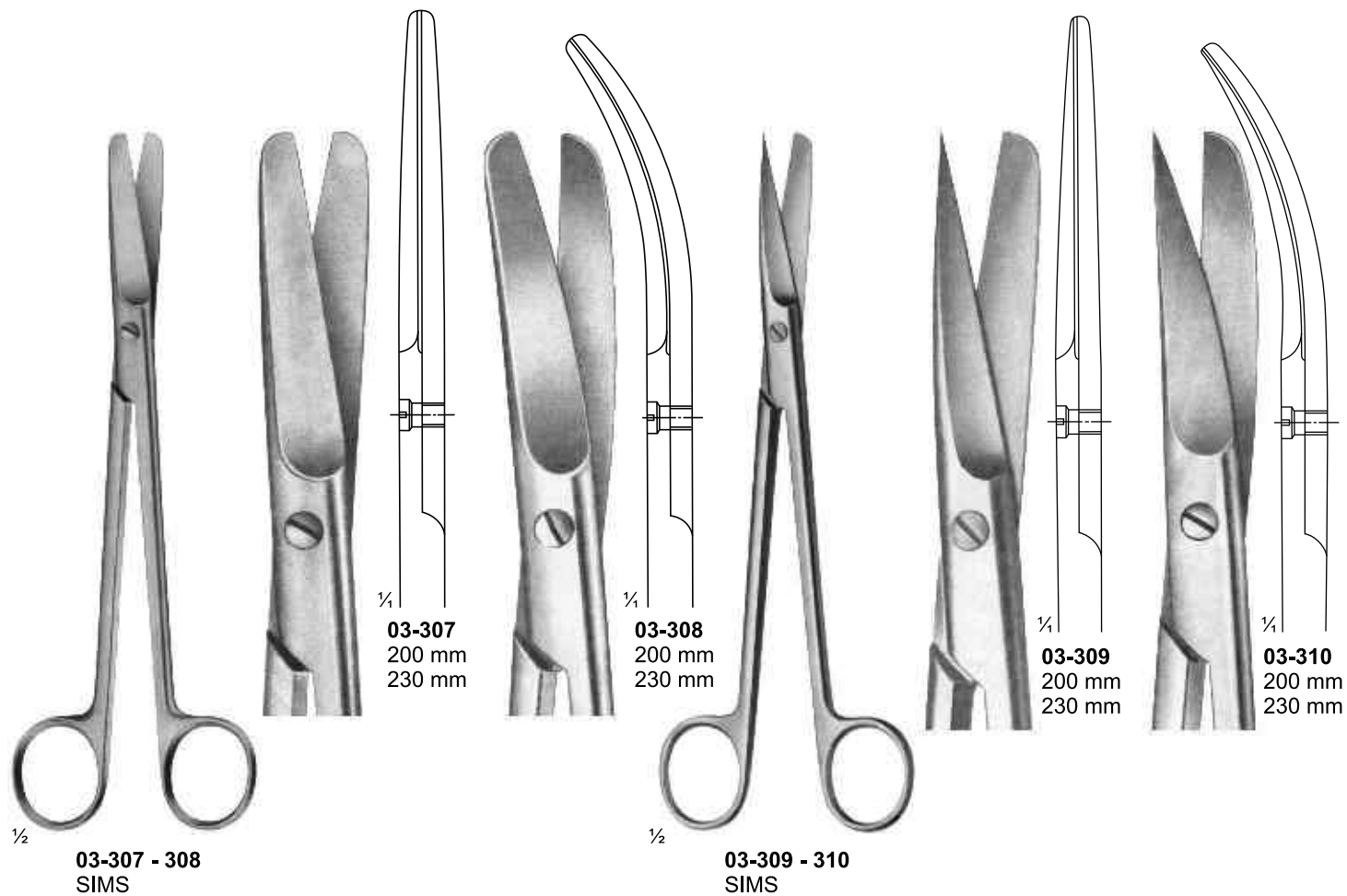

# Operating and Gynaecology Scissors

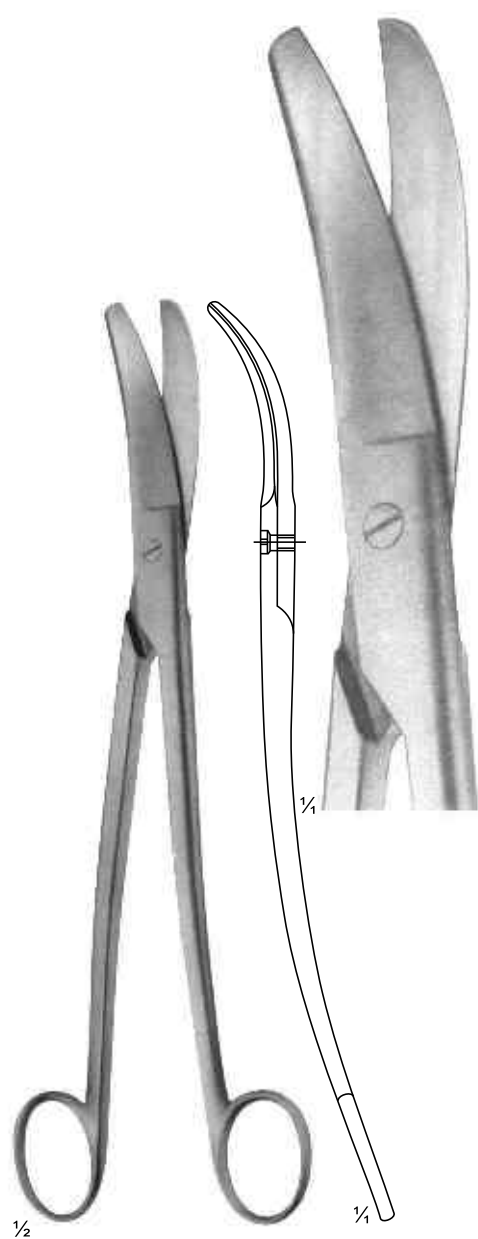

**03-316**  
SIEBOLD  
Uterine Scissors  
Size: 245 mm

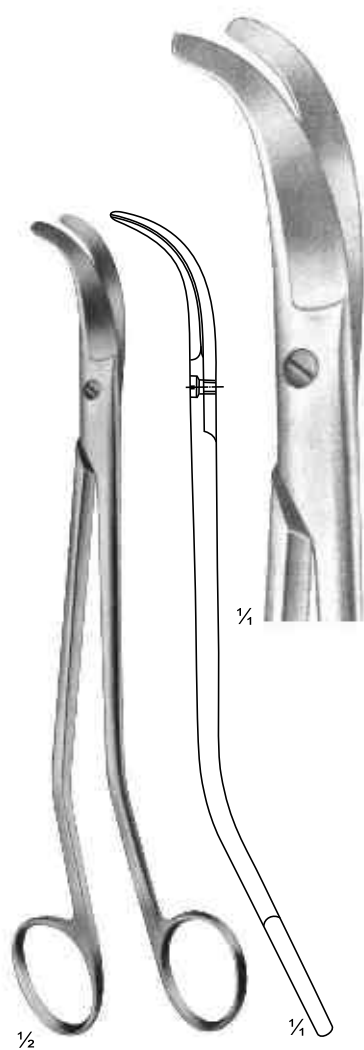

**03-317**  
BOZEMANN  
Uterine Scissors  
Size: 220 mm

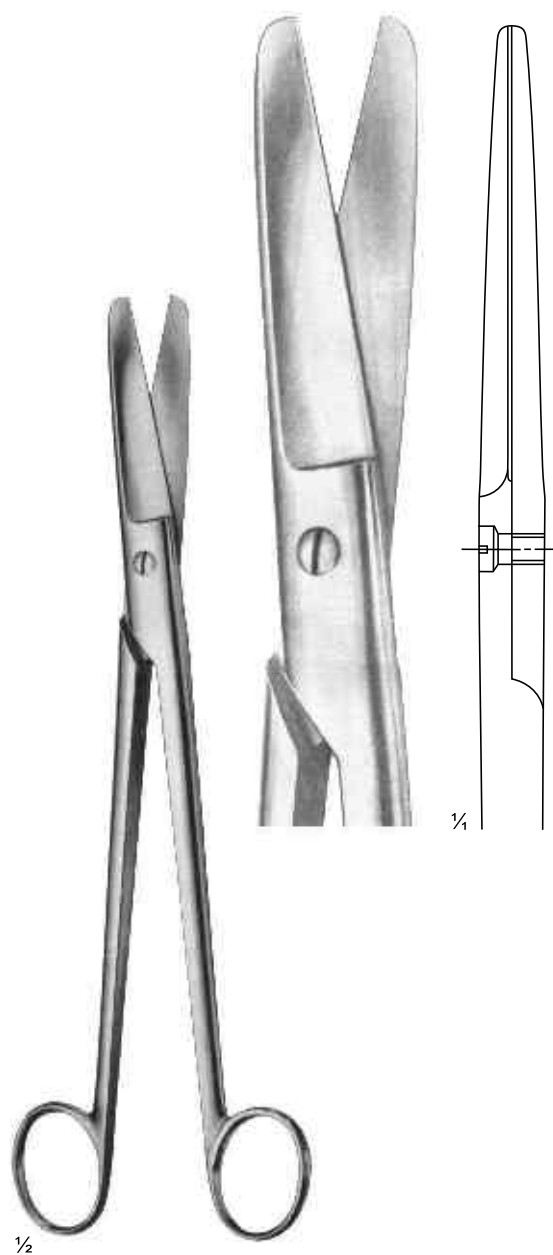

**03-318**  
SIMS-SIEBOLD  
Uterine Scissors  
Size: 250 mm

# Operating and Gynaecology Scissors



**03-319**  
**SCHUMACHER**  
 Umbilical Cord Scissors  
 Size: 155 mm

**03-320**  
 Umbilical Cord Scissors  
 Size: 105 mm

**03-321**  
 Umbilical Cord Scissors  
 135 mm

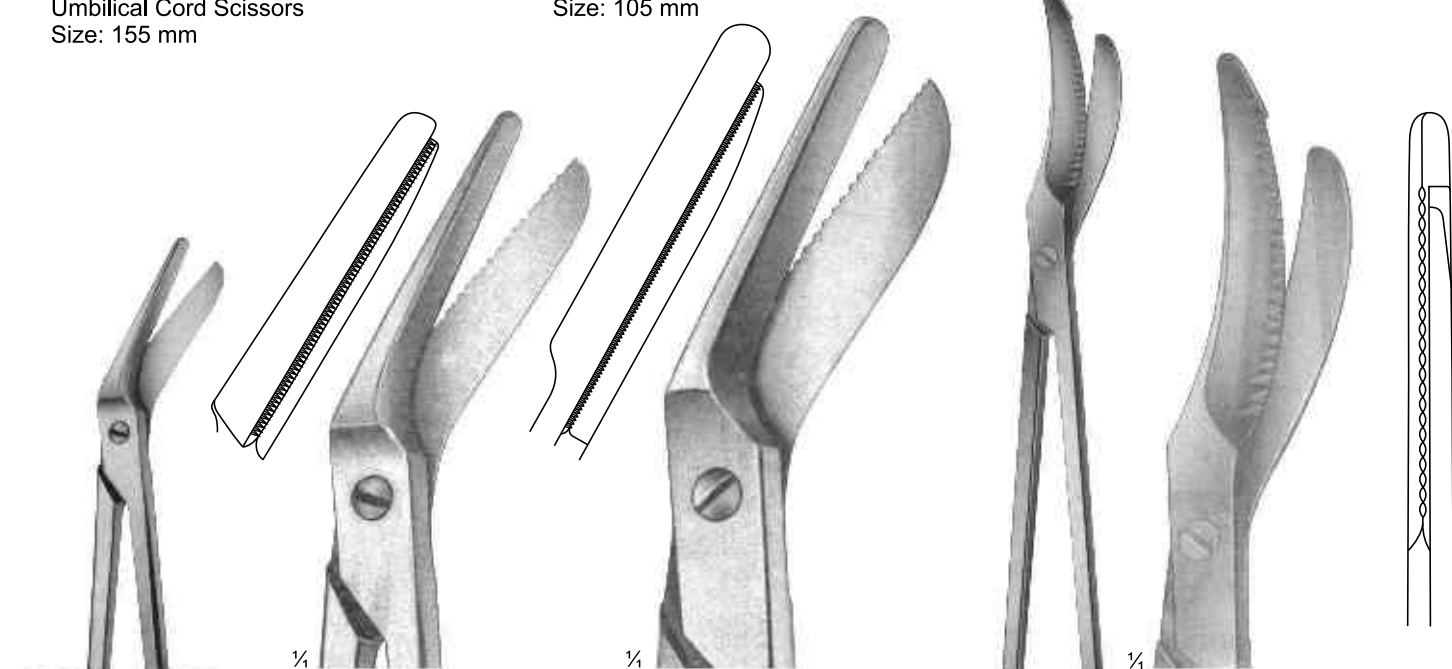

**03-322 - 323**  
**BRAUN-STADLER**  
 Episiotomy Scissors

**03-322**  
 145 mm

**03-323**  
 200 mm

**03-324**  
**DAMMSCHERE**  
 Episiotomy Scissors  
 240 mm

## Bowel Scissors, Cartilage Scissors

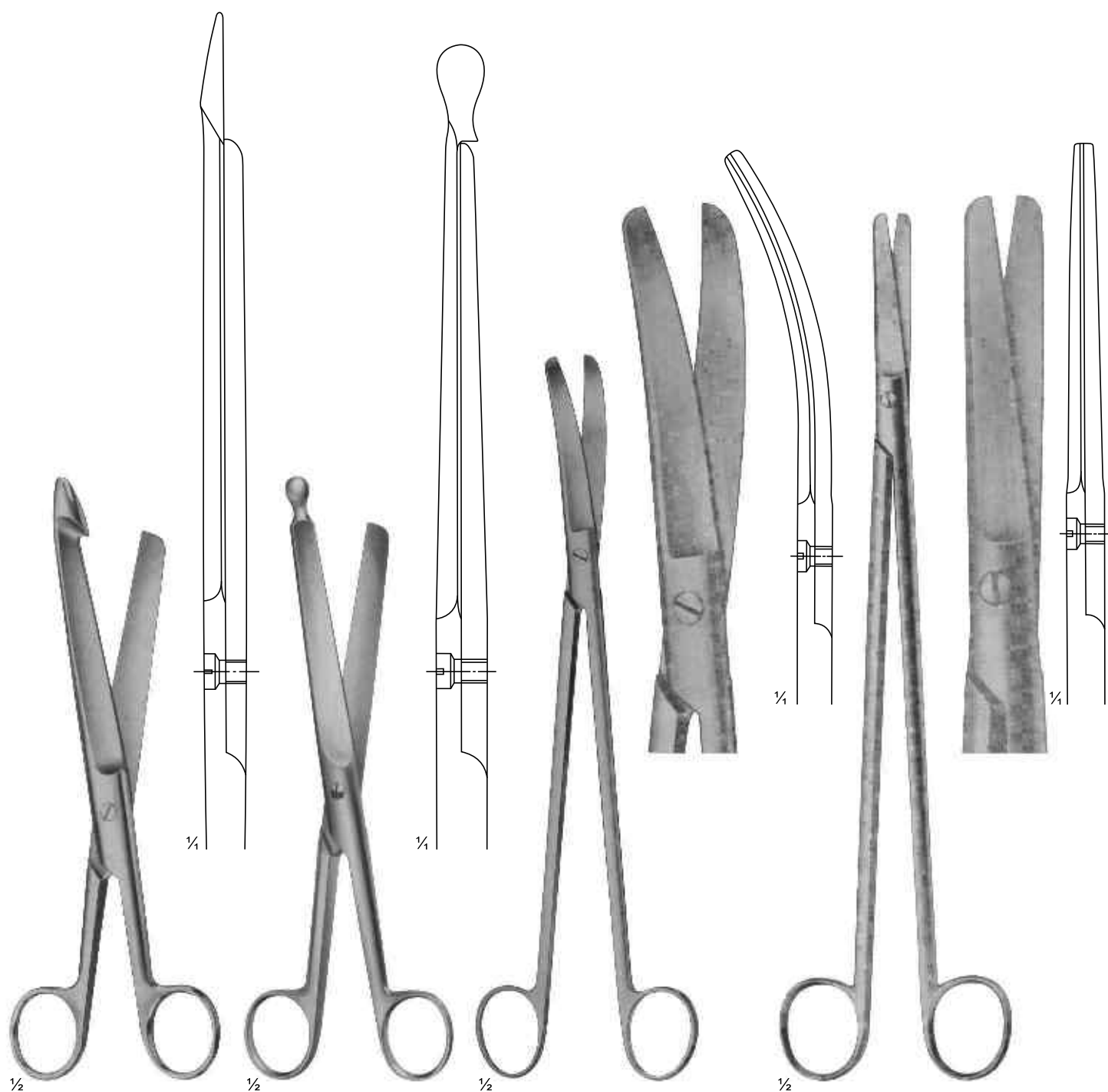

**03-325**  
DAMMSCHERE  
Bowel Scissors  
Size: 210 mm

**03-326**  
DAMMSCHERE  
Bowel Scissors  
Size: 210 mm

**03-327**  
LLOYD-DAVIES  
(GOLIGHER'S)  
Rectal Scissors  
Size: 255 mm

**03-328**  
STELZNER  
Rectal Scissors  
Size: 310 mm



# Ligature Scissors

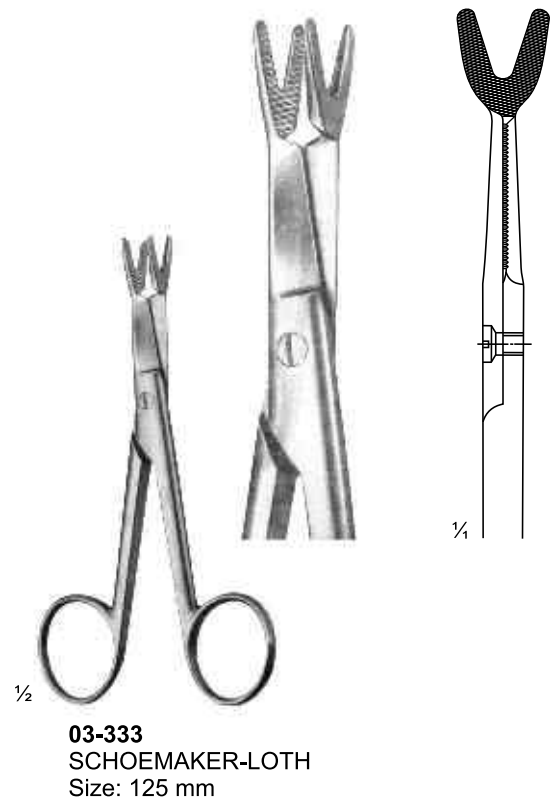
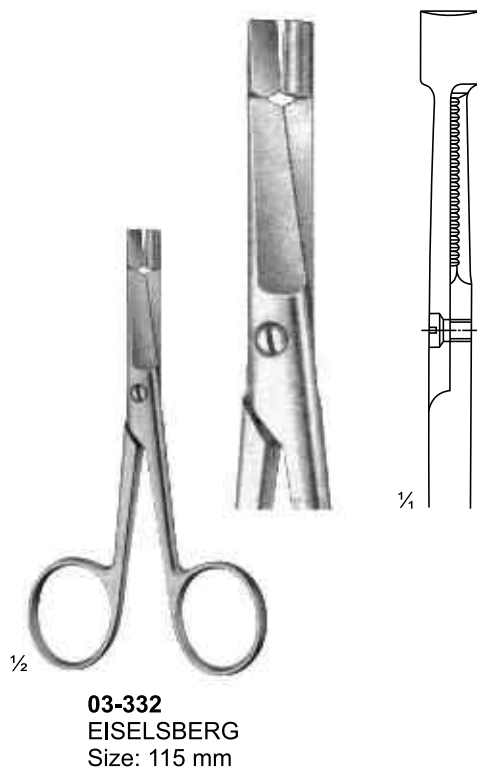
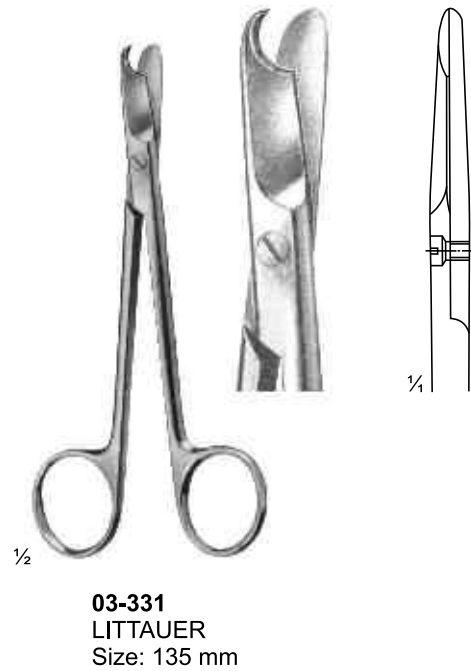
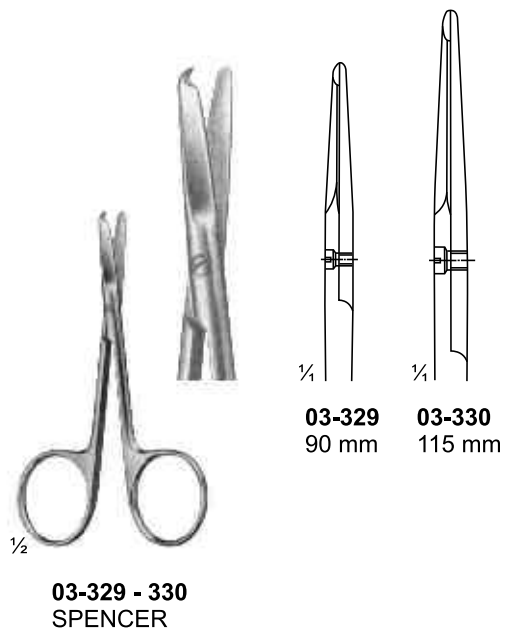

# Wire and Plate Scissors



1/2

**03-334 - 338**  
BEEBE  
Size: 110 mm

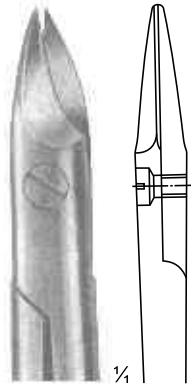

1/4

**03-334**

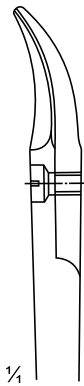

1/4

**03-335**

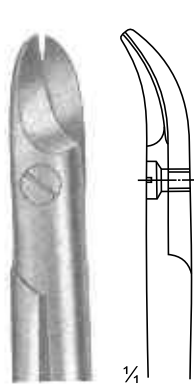

1/4

**03-336**  
Broad Blades

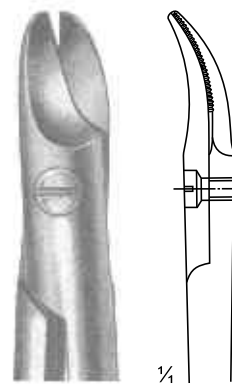

1/4

**03-337**  
1 Blade Serrated

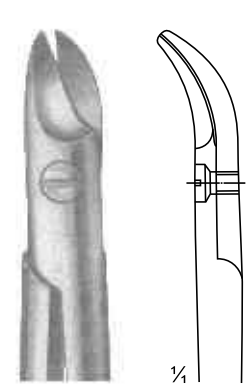

1/4

**03-338**  
NAUJOKS  
Strongly Curved

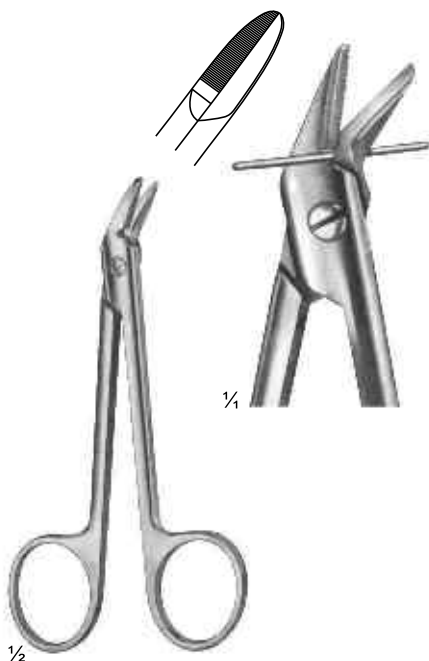

1/2

**03-339**  
1 Blade Serrated  
Size: 120 mm

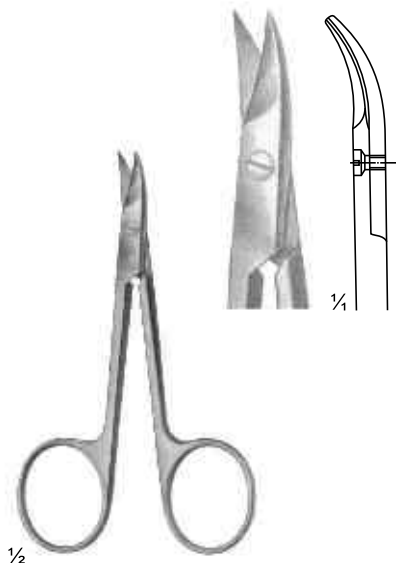

1/2

**03-340**  
STRACK  
Size: 100 mm

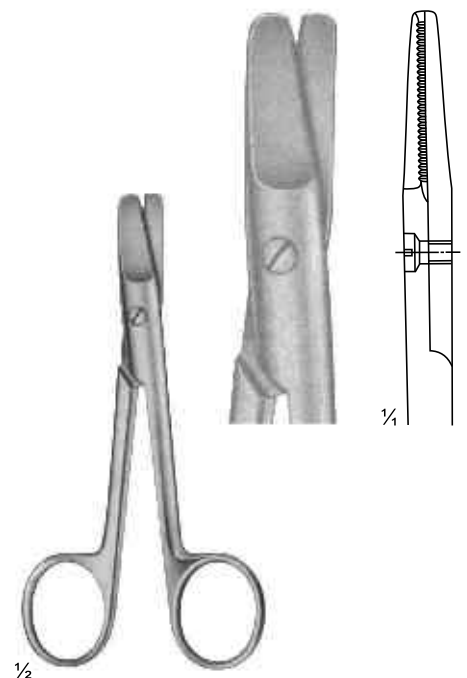

1/2

**03-341**  
HARVEY  
Size: 125 mm

# Wire and Plate Scissors

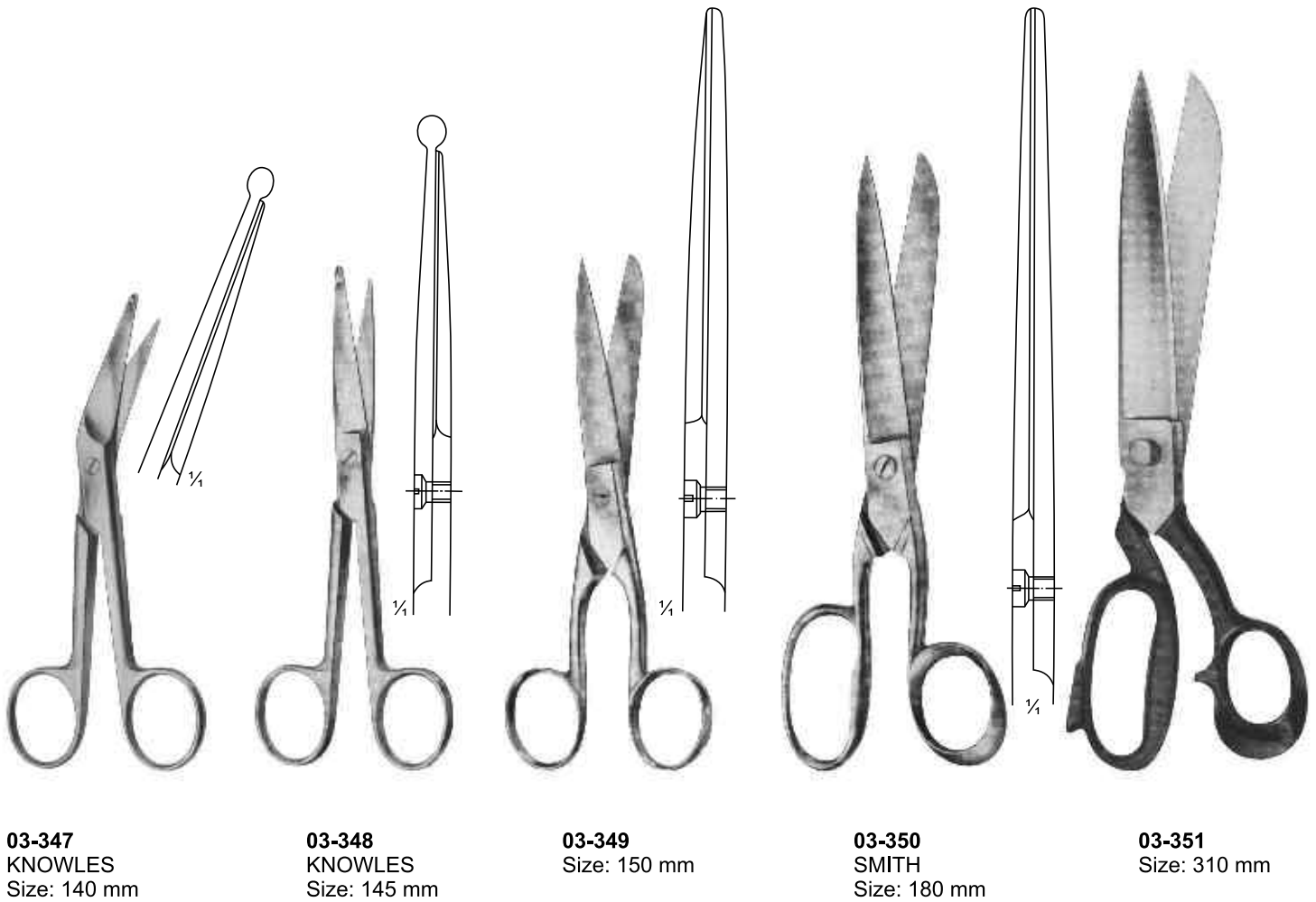
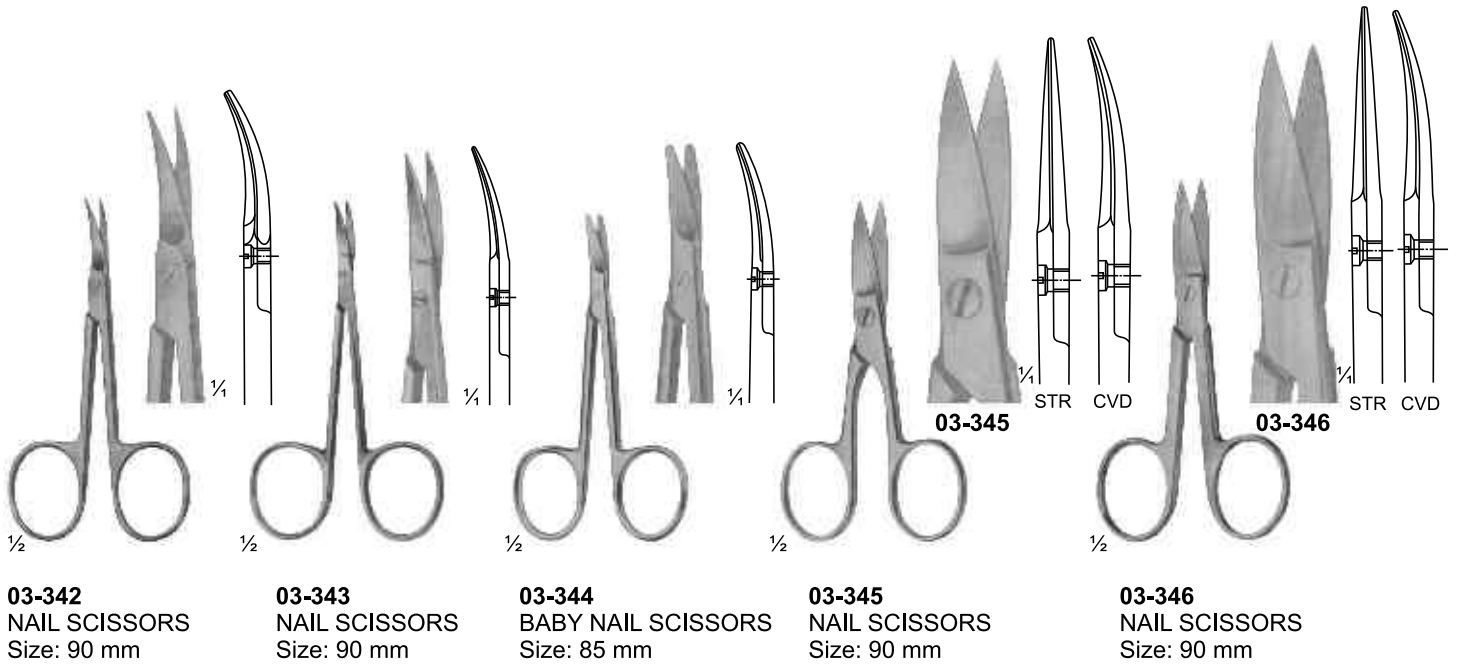

# Bandage and Cloth Scissors



**03-352**  
UNIVERSAL AND BANDAGE SCISSORS  
180 mm

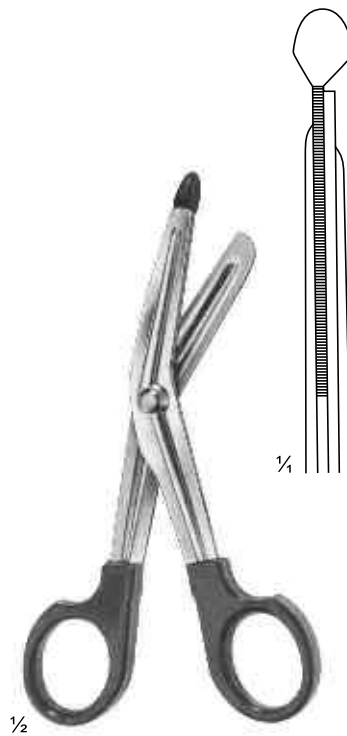

**03-353**  
LISTER  
Size: 145 mm

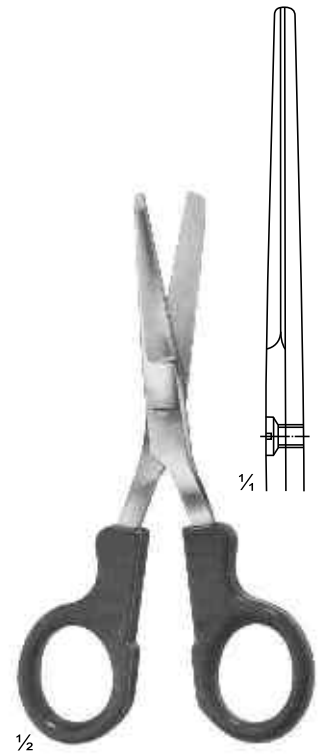

**03-354**  
LISTER  
Size: 145 mm

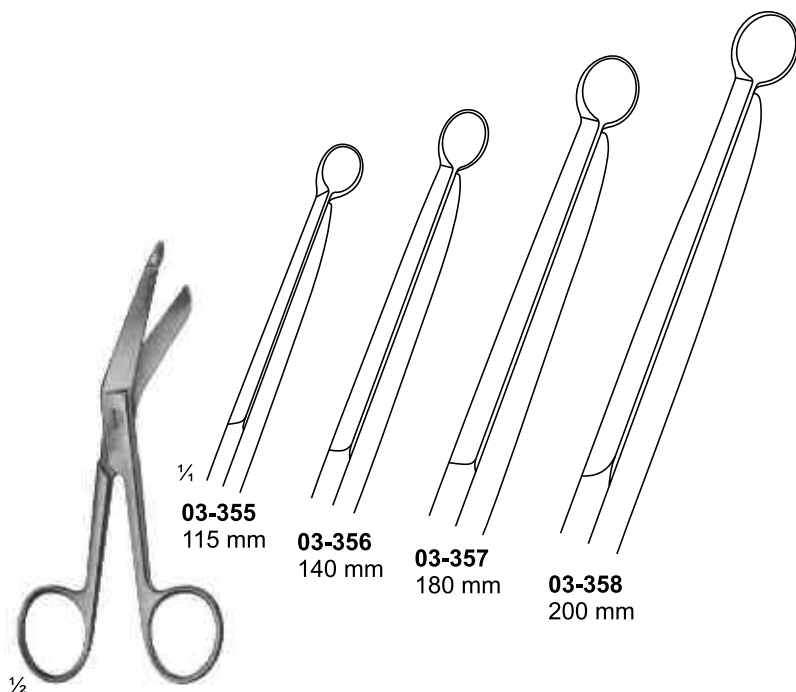

**03-355 - 358**  
LISTER

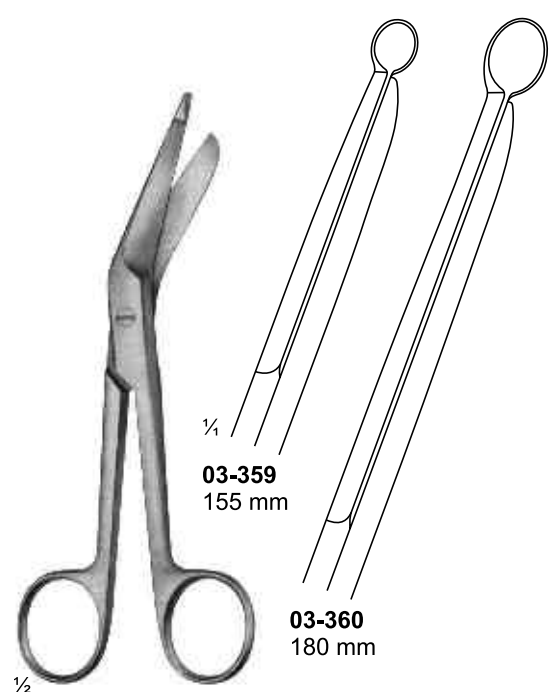

**03-359 - 360**  
LISTER

# Bandage, Cloth and Plaster Scissors



**03-361**  
CLOTH SCISSORS  
205 mm

**03-362**  
BRAUN-STADLER  
225 mm

**03-363**  
SEUTIN  
230 mm

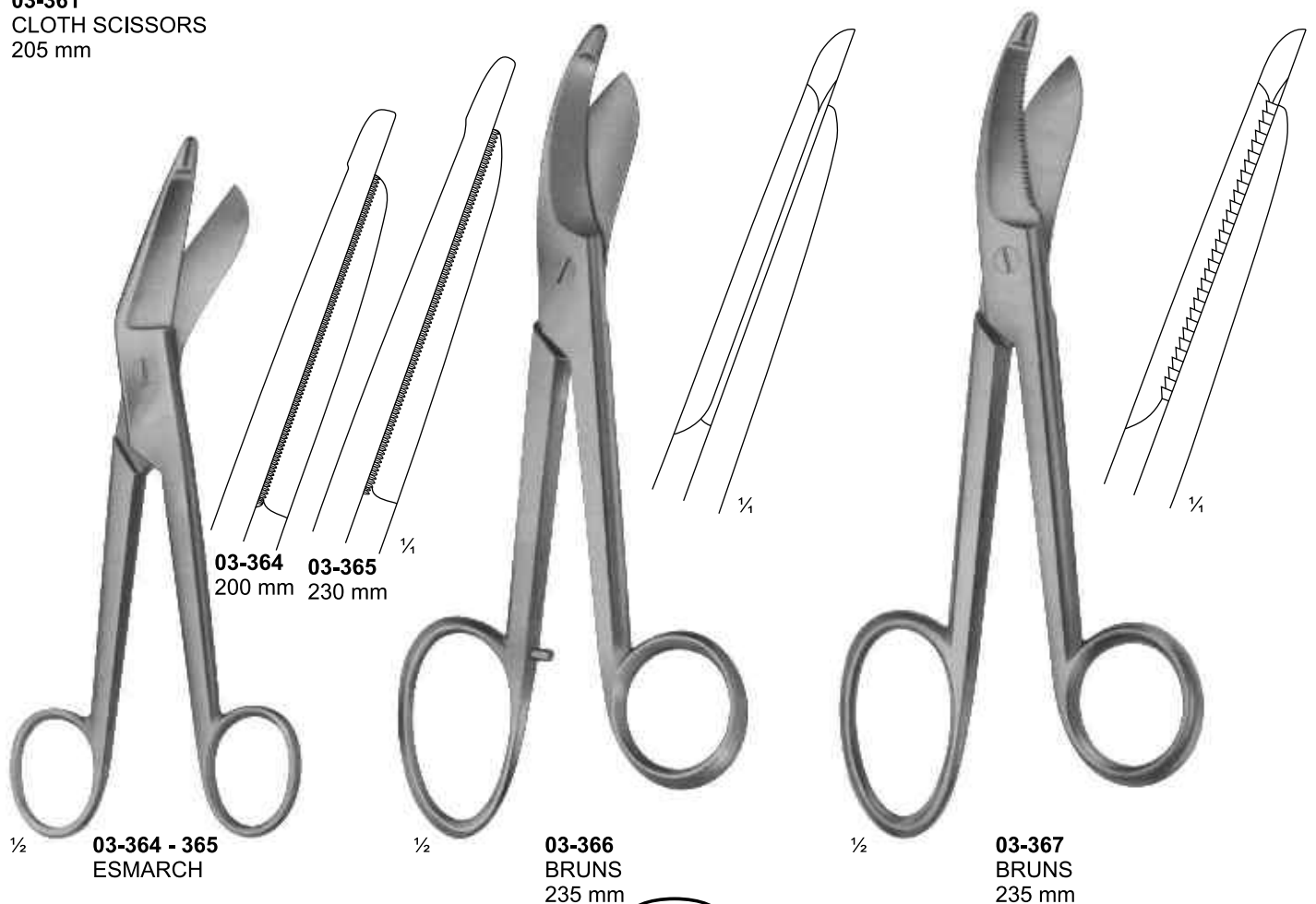

**03-364** **03-365**  
200 mm 230 mm

**03-364 - 365**  
ESMARCH

**03-366**  
BRUNS  
235 mm

**03-367**  
BRUNS  
235 mm

# Micro Forceps, Jeweler Types

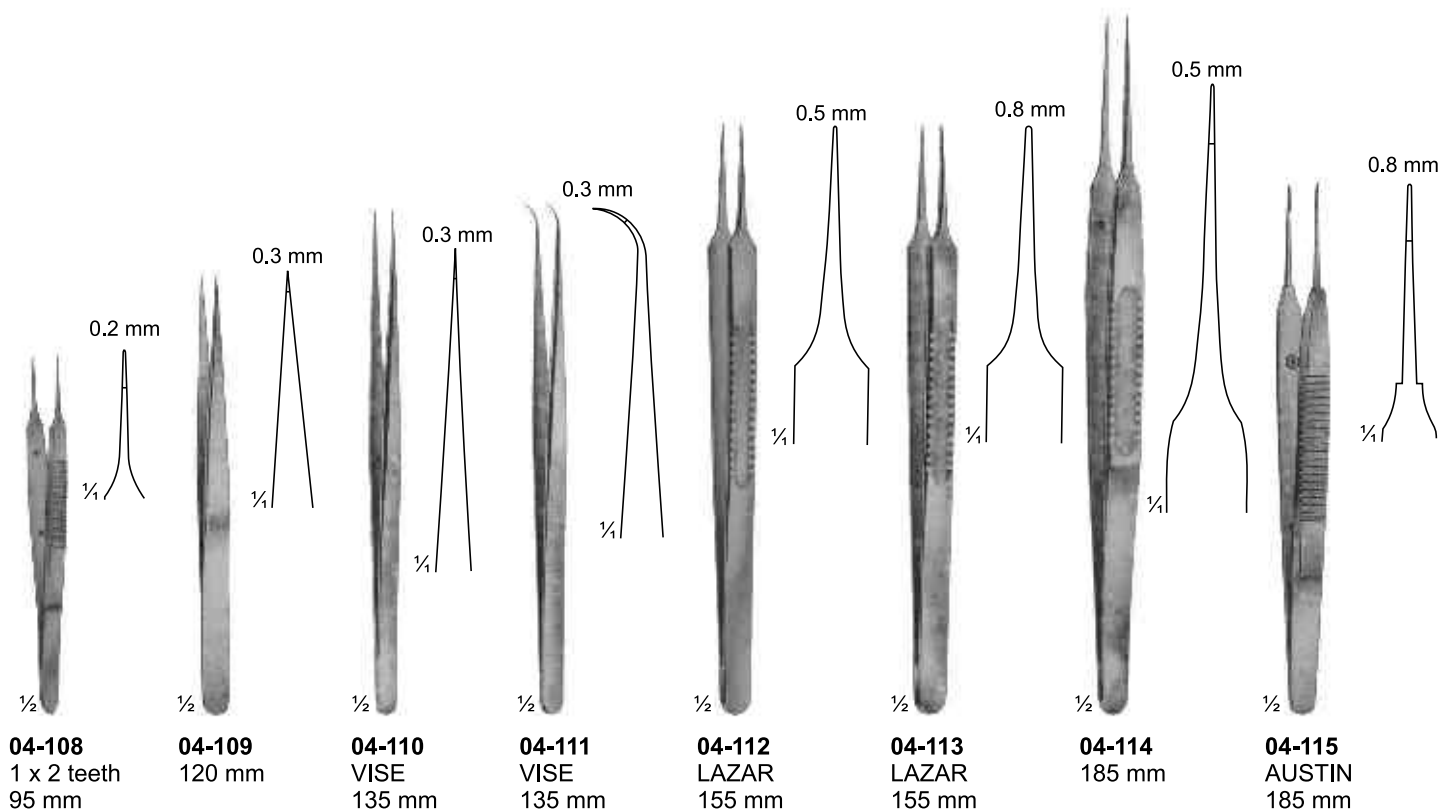
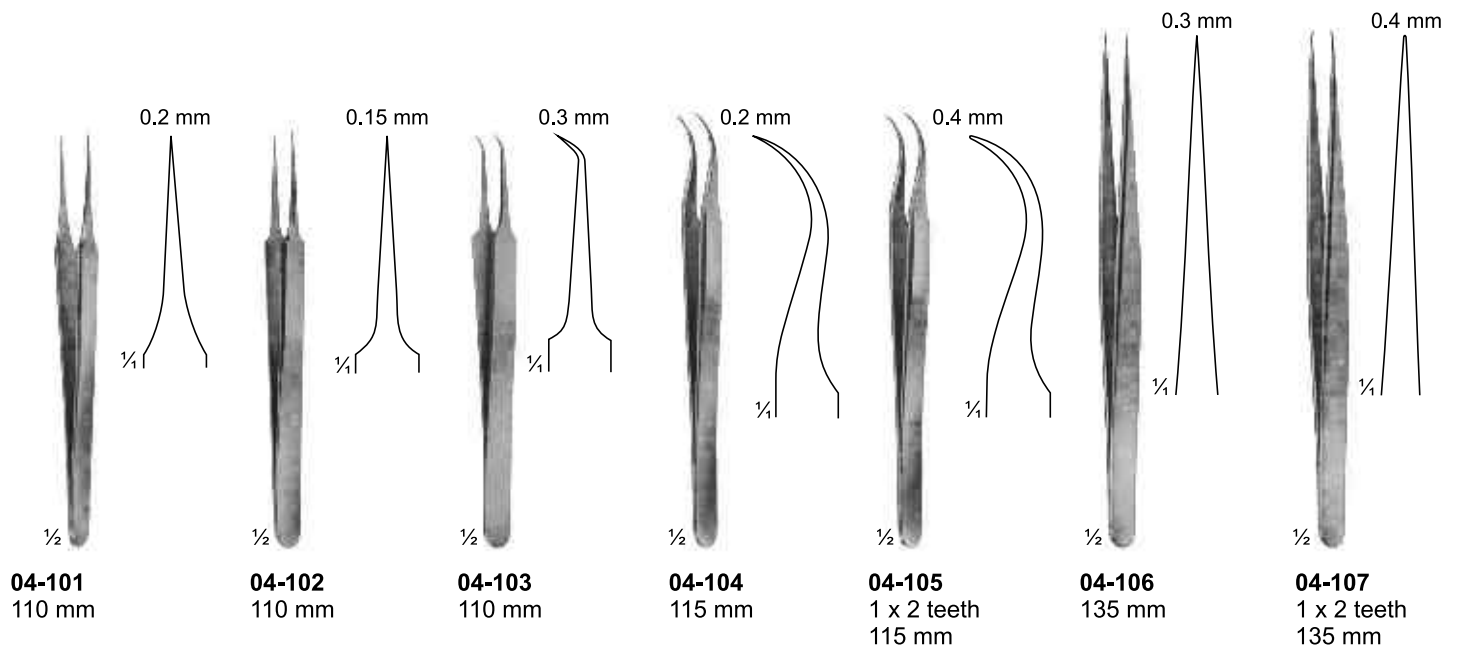

# Ligature Forceps, Micro Forceps (Light Patterns)

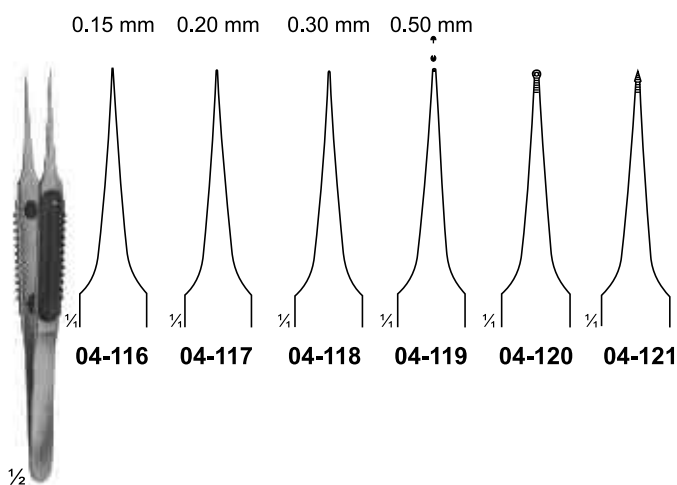

**04-116 - 121**  
MULLER  
110 mm

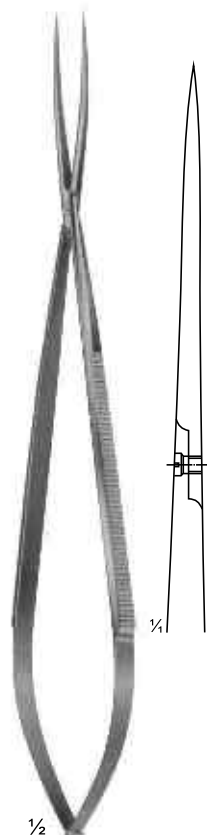

**04-122**  
LIGATURE FORCEPS  
220 mm



**04-123**  
YASARGIL  
185 mm

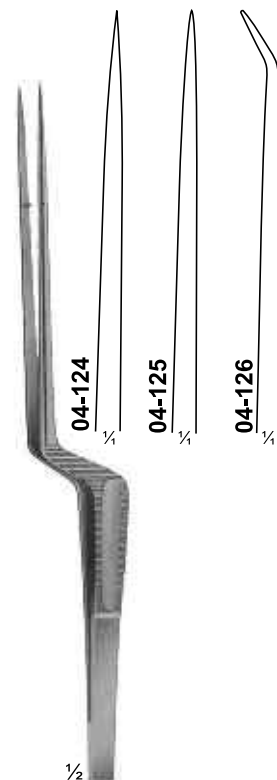

**04-124 - 126**  
MICRO FORCEPS  
185 mm

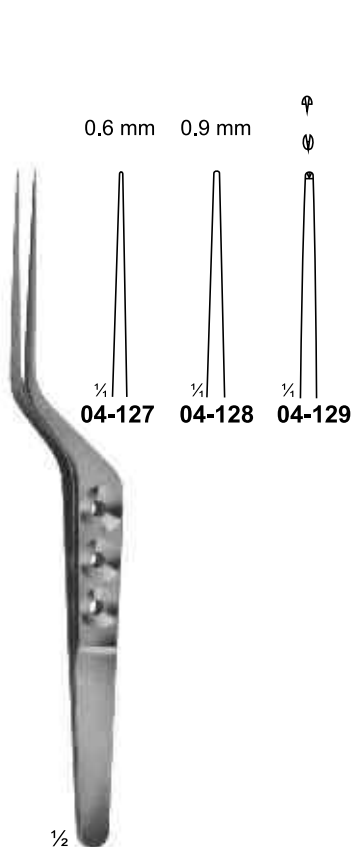

**04-127 - 129**  
YASARGIL  
180 mm

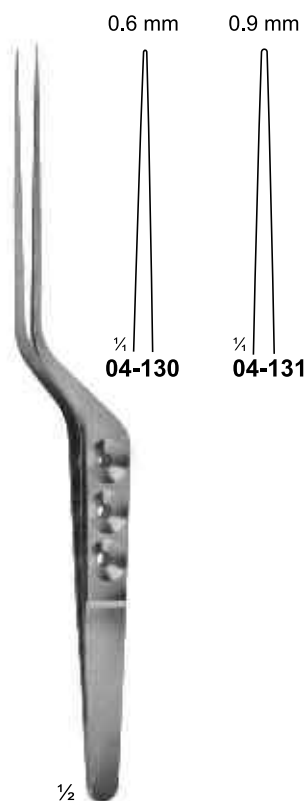

**04-130 - 131**  
YASARGIL  
200 mm



**04-132 - 133**  
YASARGIL  
220 mm

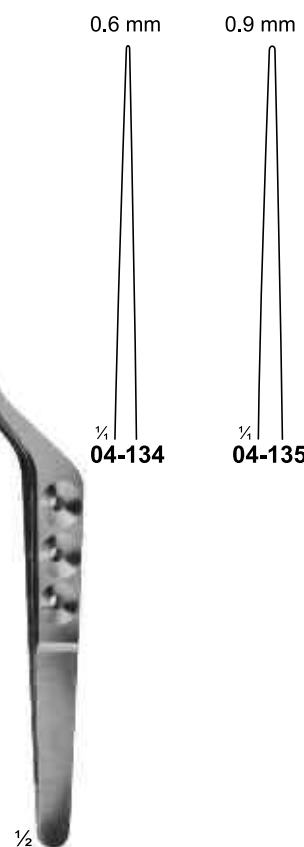
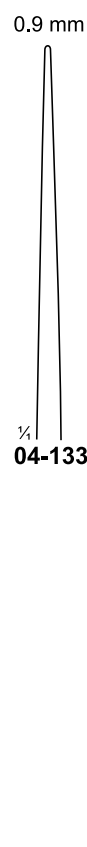

**04-134 - 135**  
YASARGIL  
240 mm

# Forceps for Grasping Tissue, Tumors

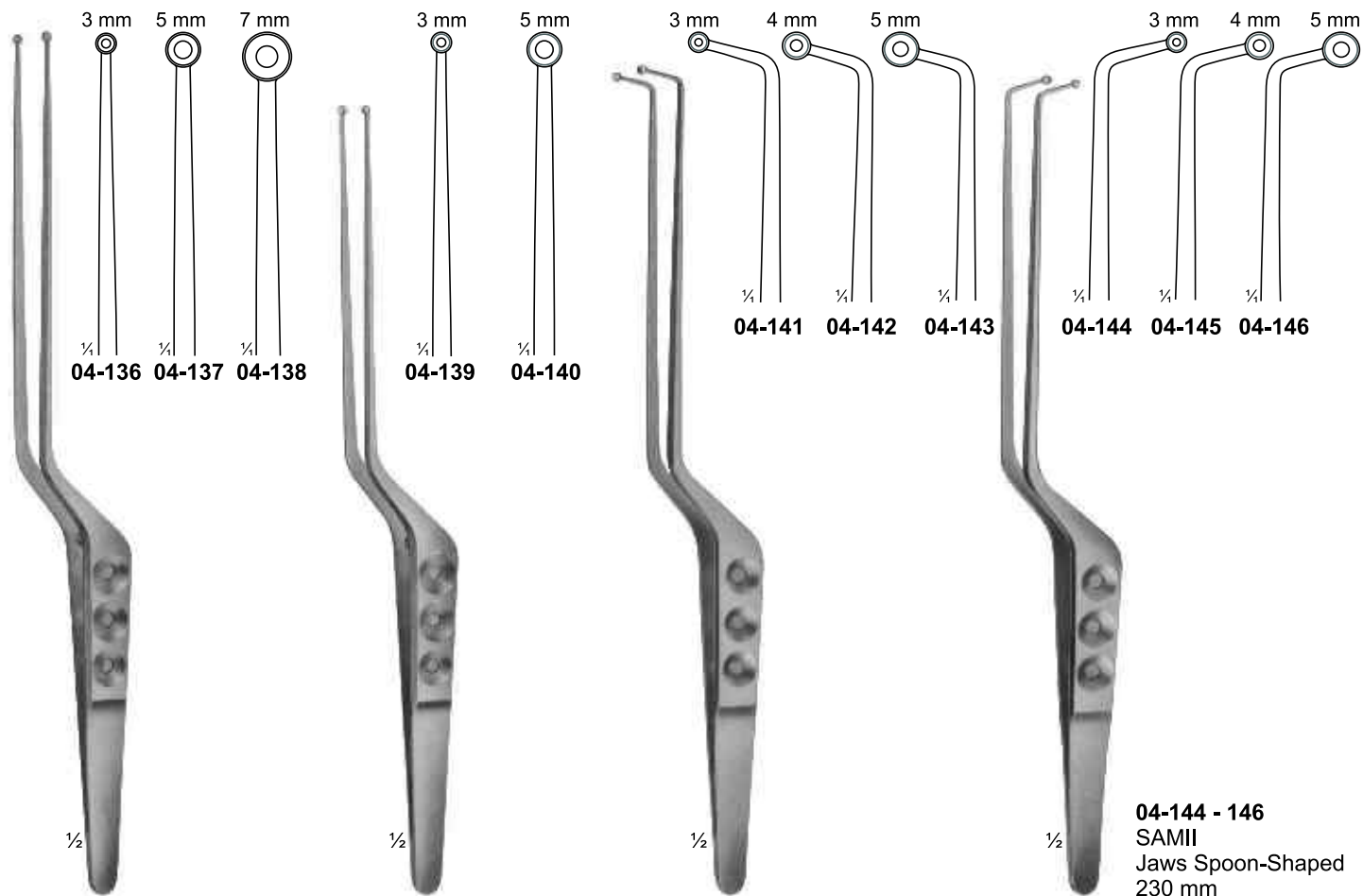

**04-136 - 138**  
YASARGIL-SAMI  
Jaws Spoon-Shaped  
240 mm

**04-139 - 140**  
YASARGIL  
Jaws Spoon-Shaped  
220 mm

**04-141 - 143**  
SAMII  
Jaws Spoon-Shaped  
230 mm

**04-144 - 146**  
SAMII  
Jaws Spoon-Shaped  
230 mm

**04-147**  
HUNT  
Tumor-and Vessel Forceps  
200 mm

**04-148**  
HUNT  
Tumor-and Vessel Forceps  
200 mm

**04-149**  
YASARGIL  
Tumor-and Vessel Forceps  
200 mm



# Delicate Dissecting, Microscopic, Sterilizing Forceps

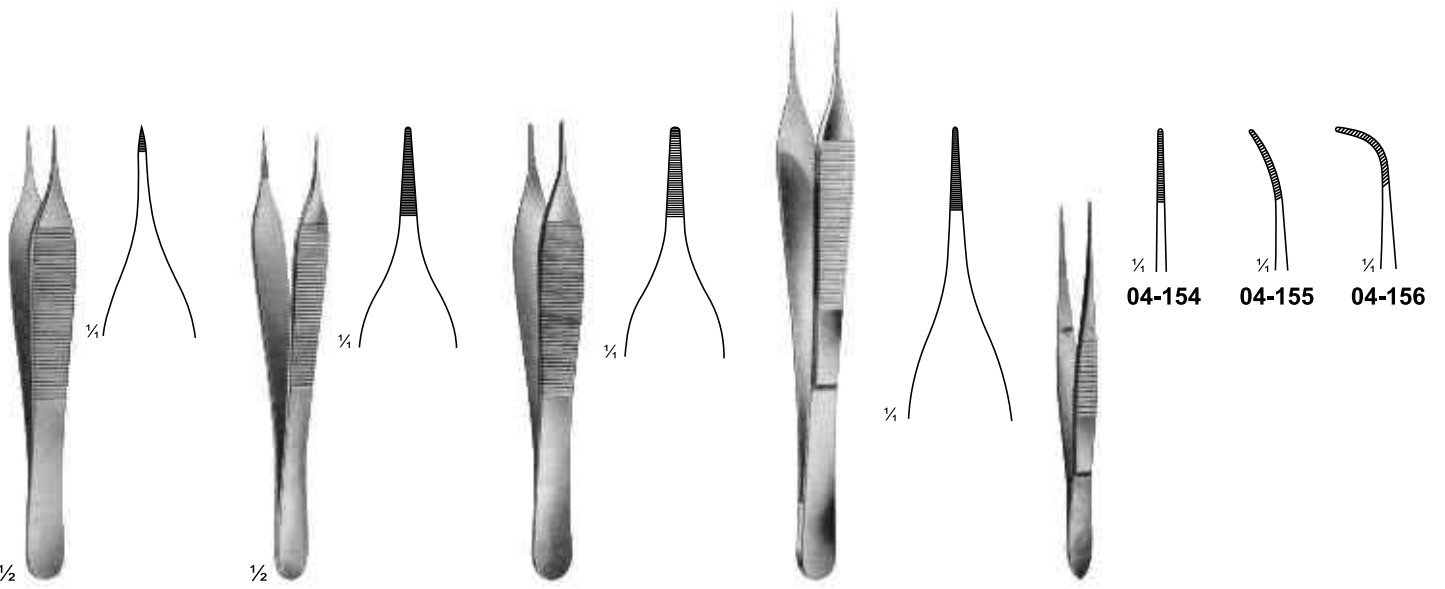

**04-150**  
**THORPE**  
 Corneal Forceps  
 120 mm

**04-151**  
**MICRO-ADSON**  
 120 mm

**04-152**  
**ADSON**  
 120 mm

**04-153**  
**MICRO-ADSON**  
 150 mm

**04-154 - 156**  
 100 mm

**04-154**   **04-155**   **04-156**

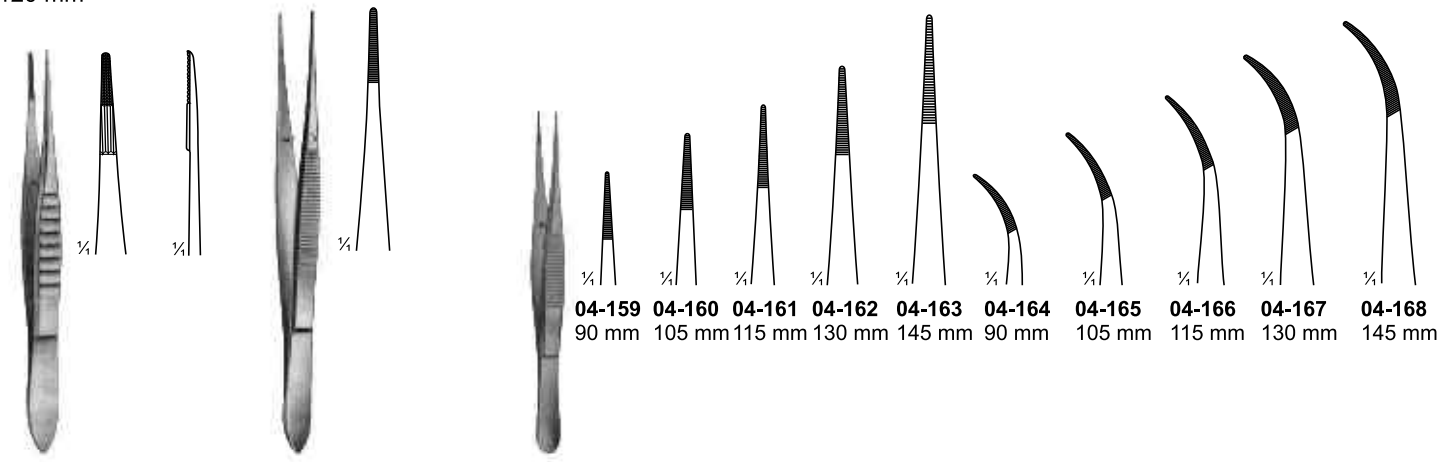

**04-157**  
 110 mm

**04-158**  
 115 mm

**04-159 - 168**

**04-159** 90 mm   **04-160** 105 mm   **04-161** 115 mm   **04-162** 130 mm   **04-163** 145 mm   **04-164** 90 mm   **04-165** 105 mm   **04-166** 115 mm   **04-167** 130 mm   **04-168** 145 mm

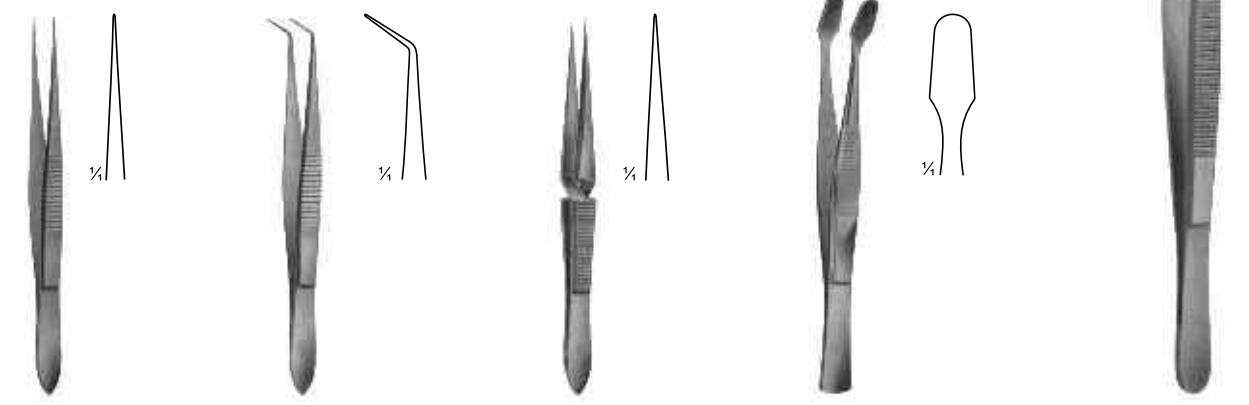

**04-169**  
 100 mm

**04-170**  
 100 mm

**04-171**  
 100 mm

**04-172**  
**COVER GLASS FORCEPS**  
 105 mm

**04-173**  
 160 mm

# Delicate Dissecting Forceps

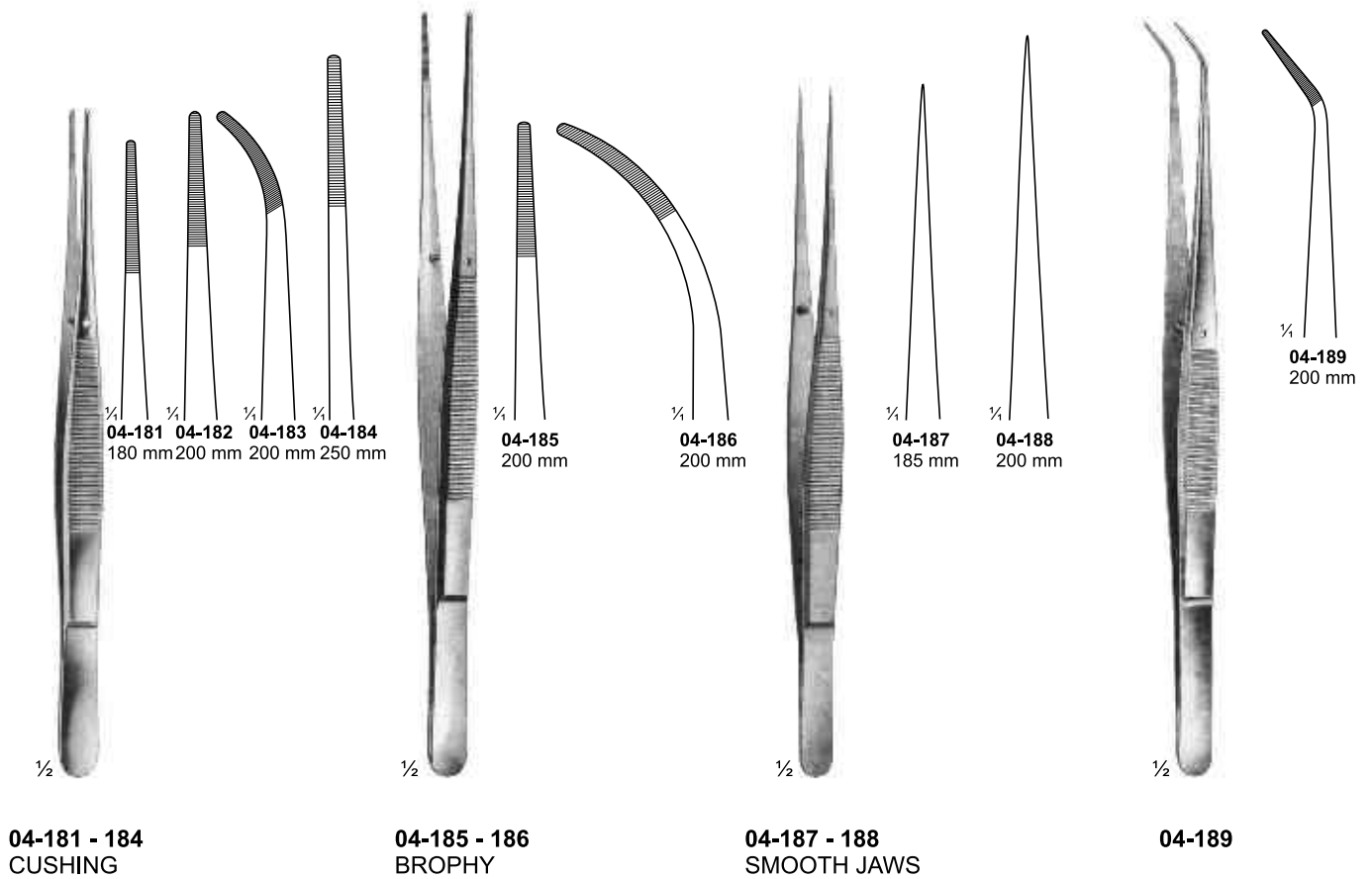
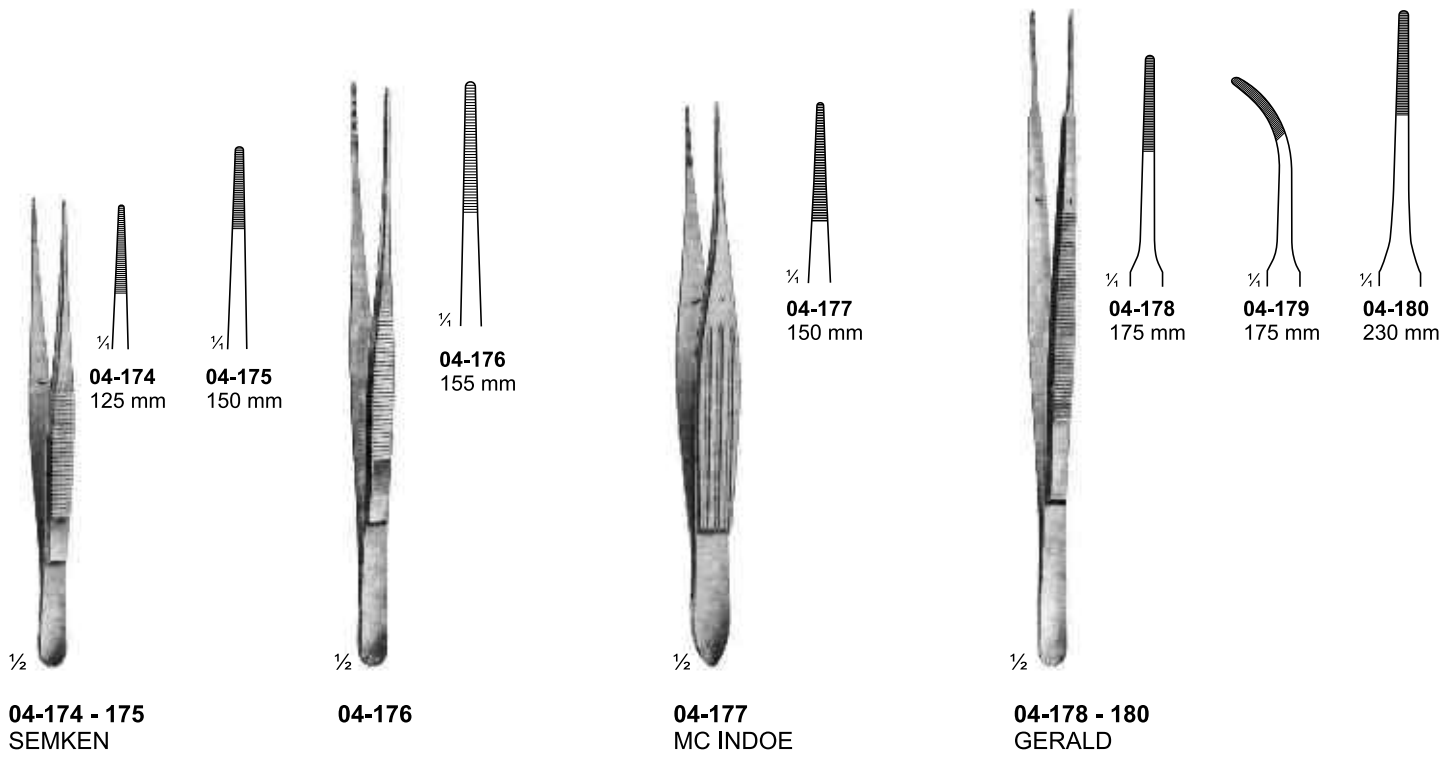

# Dissecting Forceps



1/2

**04-190 - 197**  
STANDARD

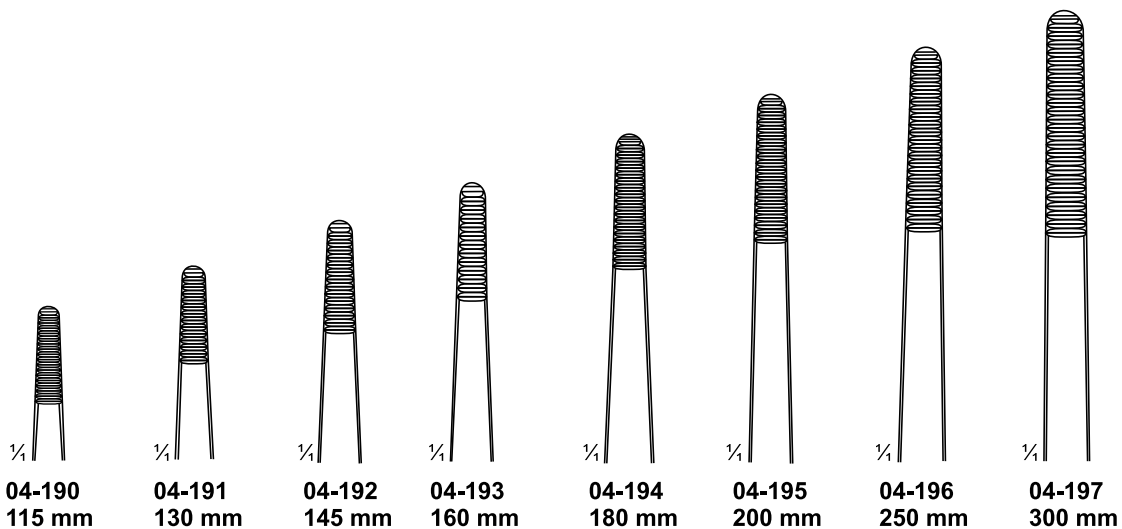

1/2

**04-198 - 202**  
MEDIUM

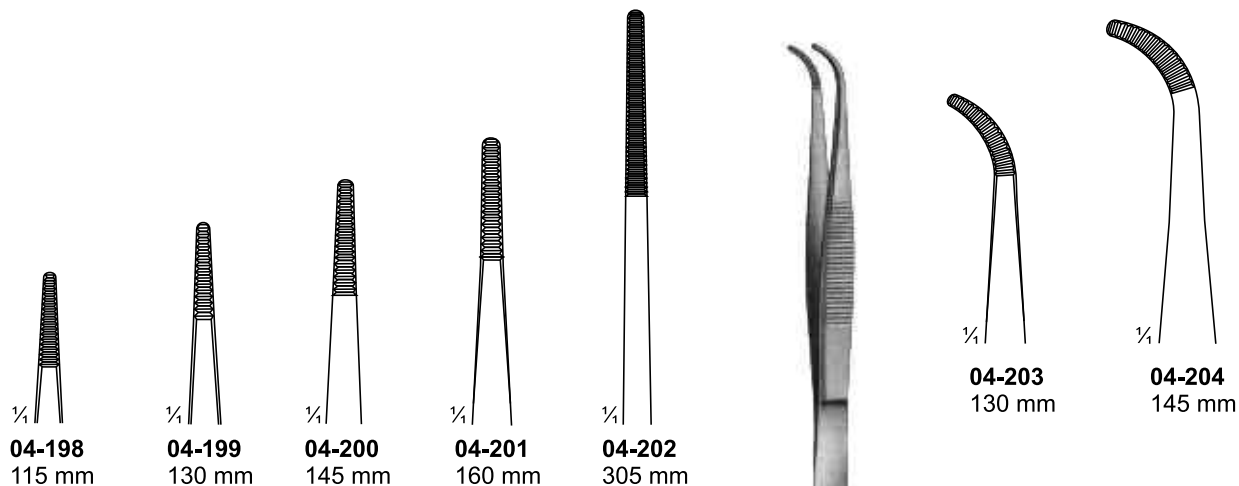

1/2

**04-203 - 204**  
MEDIUM

# Dissecting Forceps



1/2

04-205 - 206

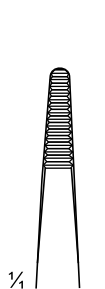

1/4

04-205  
125 mm

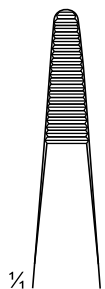

1/4

04-206  
155 mm



1/2

04-207 - 210

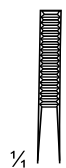

1/4

04-207  
130 mm

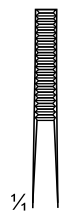

1/4

04-208  
150 mm

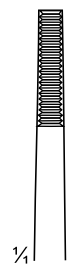

1/4

04-209  
170 mm



1/4

04-210  
200 mm



1/2

04-211  
OCHSNER

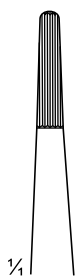

1/4



1/2

04-212  
FRICKE

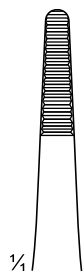

1/4



1/2

04-213  
BONNEY



1/4

# Ultra-Light Forceps

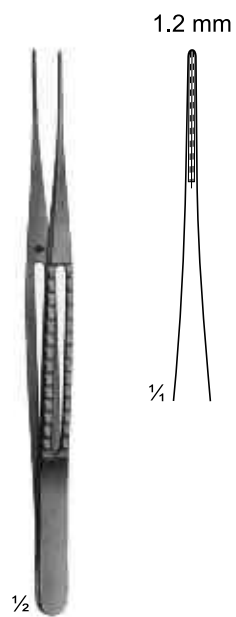

**04-214**  
150 mm

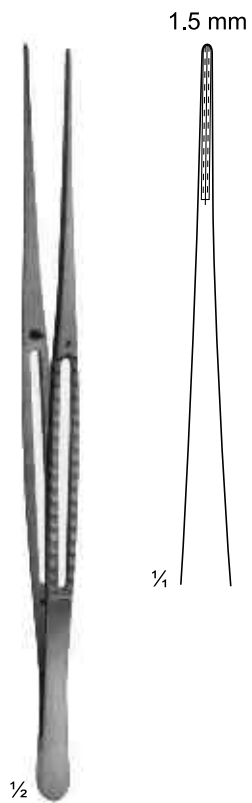

**04-215**  
200 mm

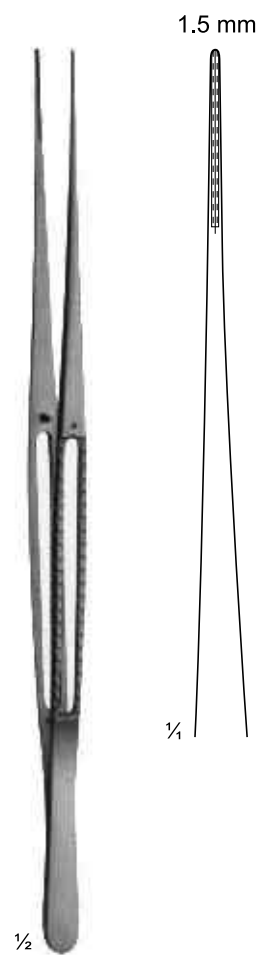

**04-216**  
240 mm

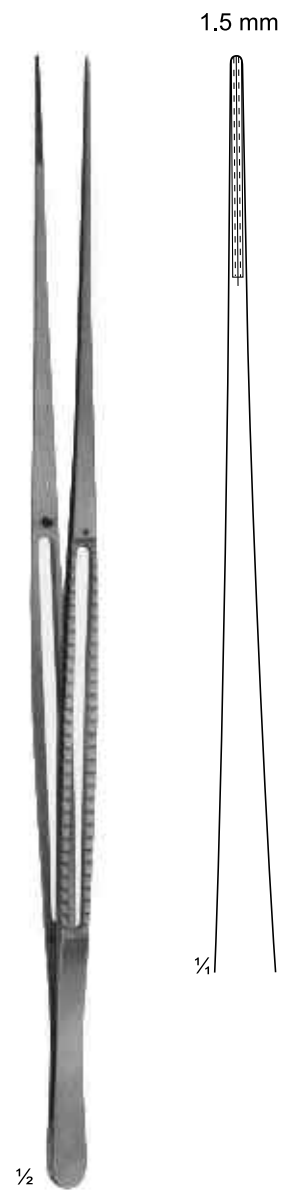

**04-217**  
300 mm

# Forceps

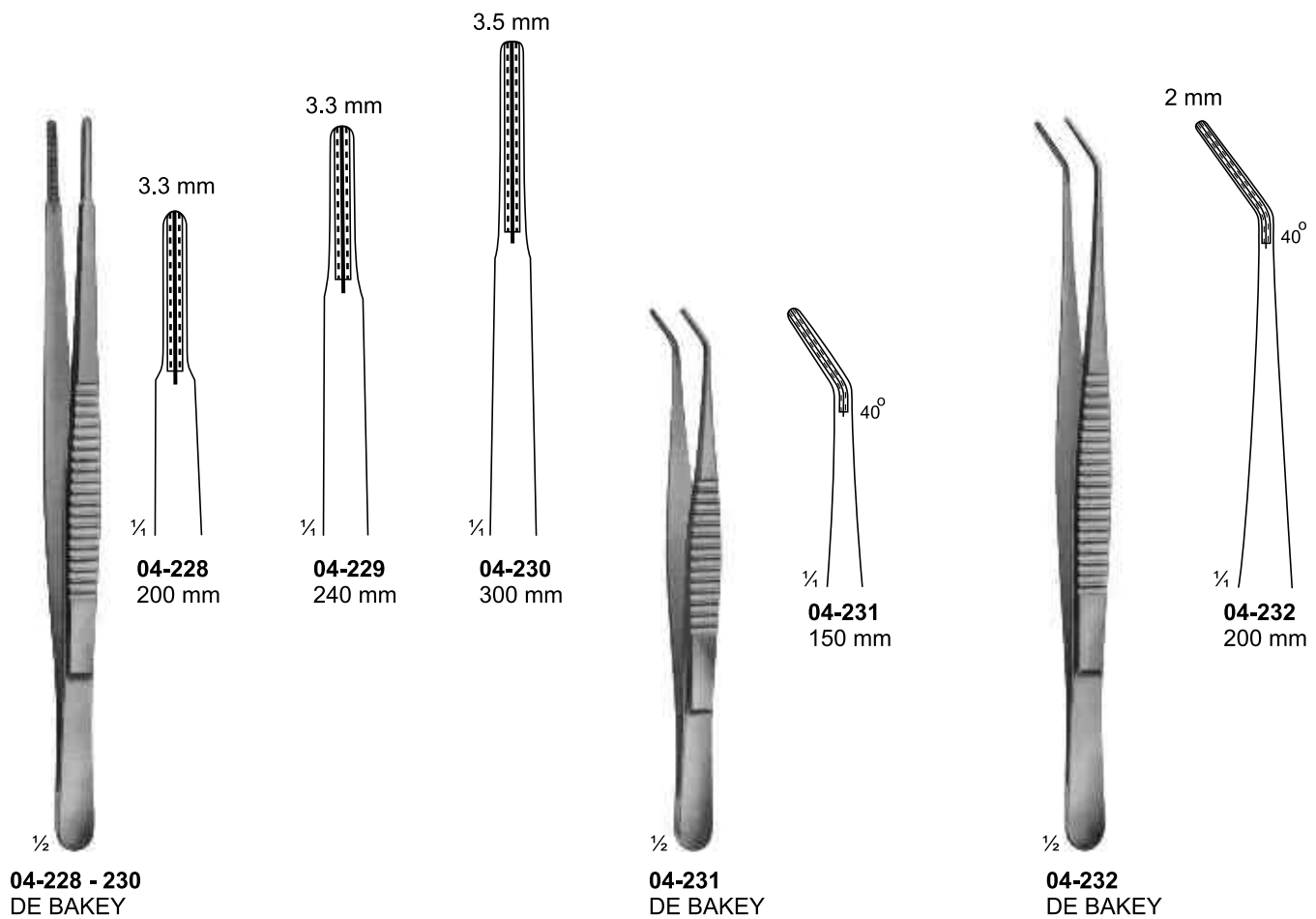
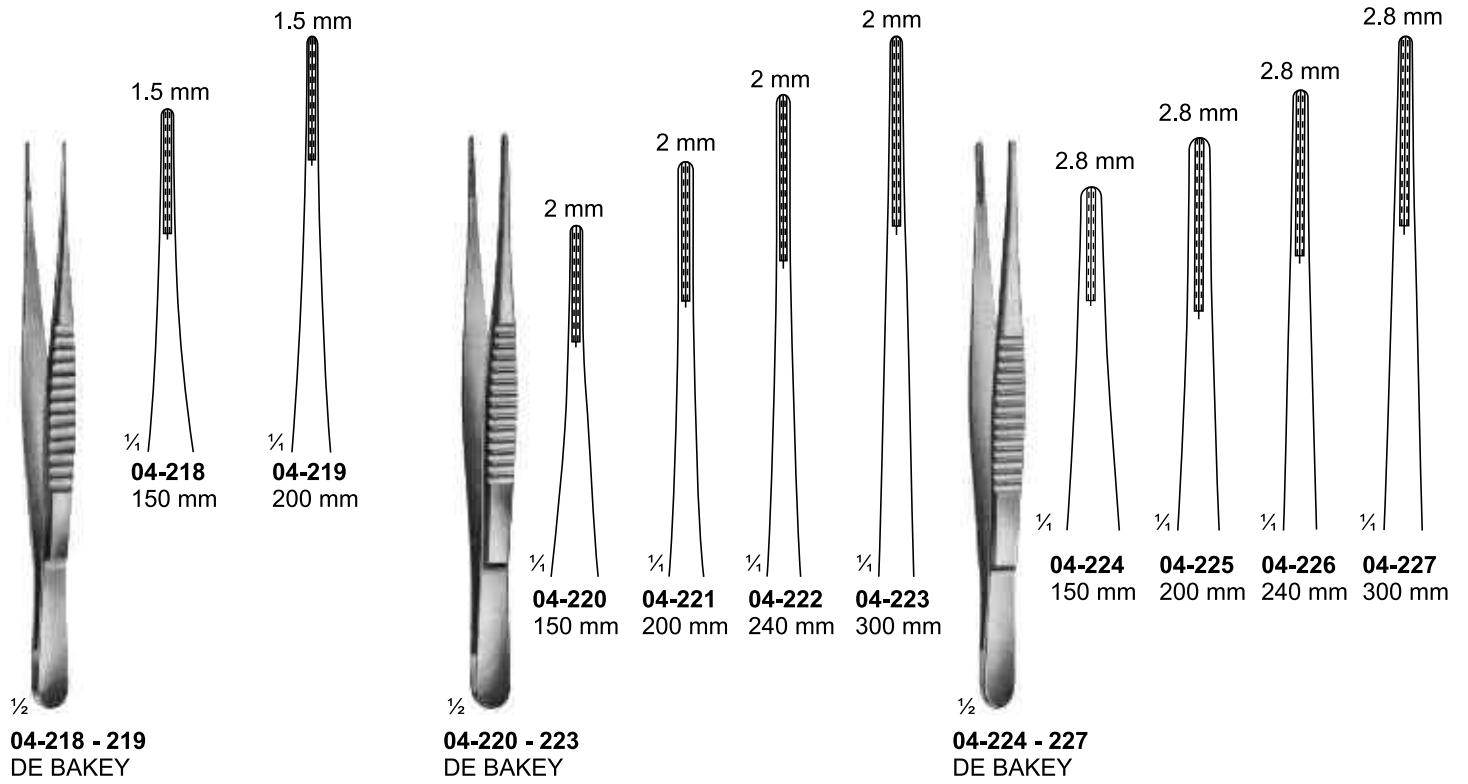

# Forceps, Bayonet - Shaped

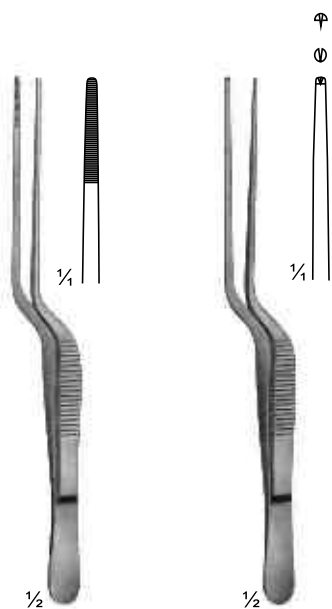

**04-233**  
LUCAE  
140 mm



**04-234**  
LUCAE  
1x2 teeth  
140 mm

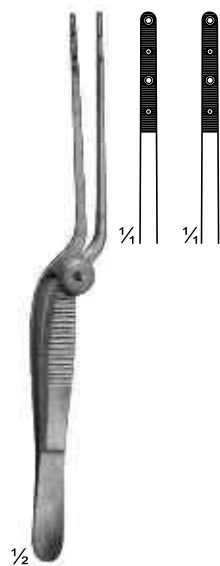

**04-235**  
COTTLE  
Forceps with  
jaws toothed  
and serrated  
140 mm

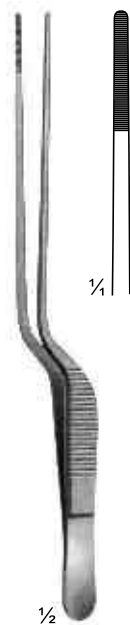

**04-236**  
JANSEN  
160 mm

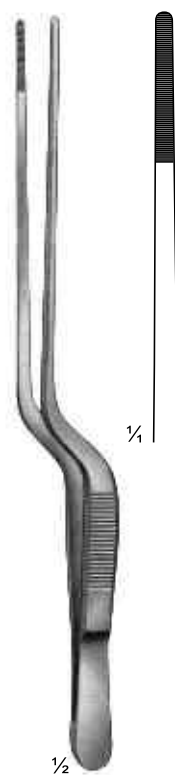

**04-237**  
GRUENWALD  
200 mm

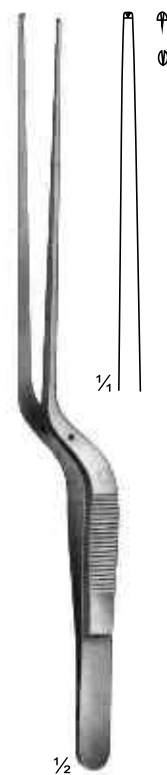

**04-238**  
1x2 teeth  
200 mm

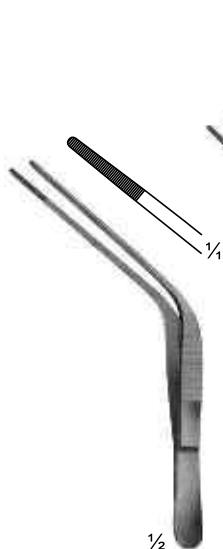

**04-239**  
TROELTSCH  
100 mm

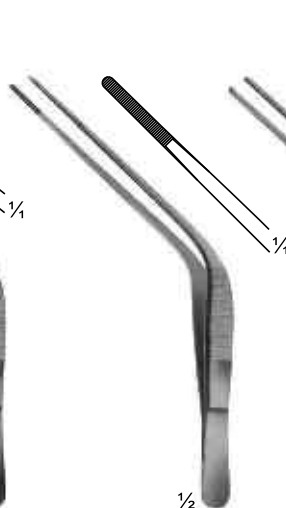

**04-240**  
TROELTSCH  
115 mm

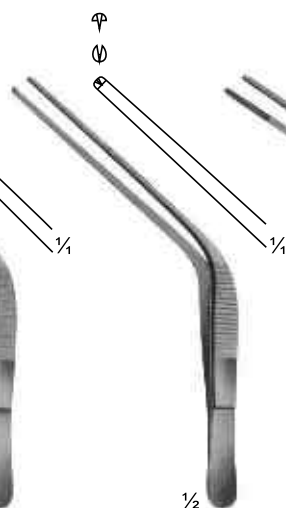

**04-241**  
TROELTSCH  
1X2 teeth  
115 mm

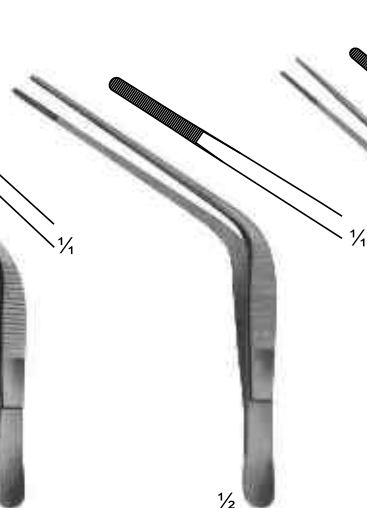

**04-242**  
WILDE  
115 mm

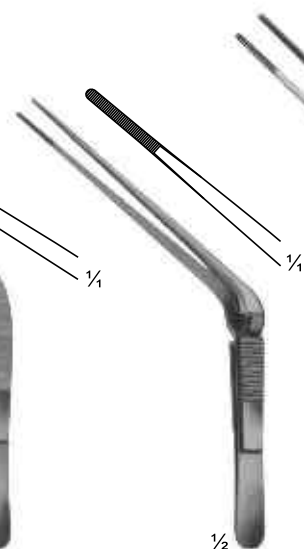

**04-243**  
TROELTSCH  
Cross action  
120 mm

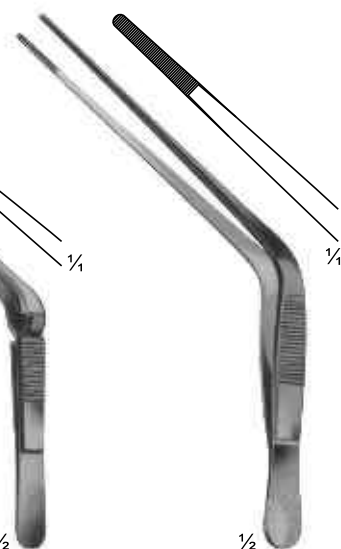

**04-244**  
TROELTSCH  
140 mm

# Delicate Tissue Forceps

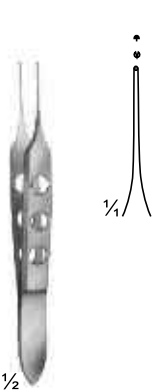

**04-245**  
BISHOP-HARMON  
85 mm

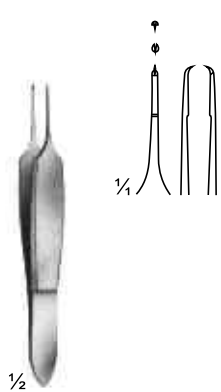

**04-246**  
ST. MARTIN  
80 mm

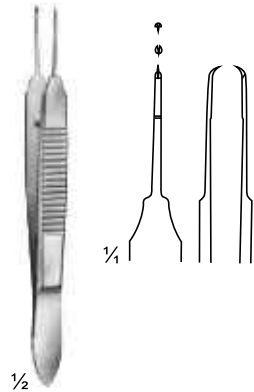

**04-247**  
CASTROVIEJO  
teeth 0.9 mm  
100 mm

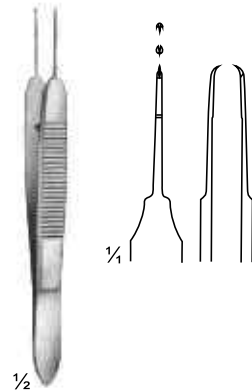

**04-248**  
CASTROVIEJO  
teeth 0.5 mm  
100 mm

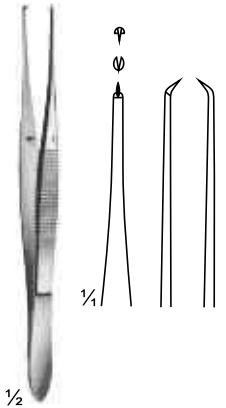

**04-249**  
ELSCHING  
110 mm

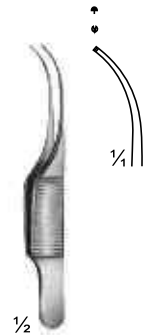

**04-250**  
GILL  
75 mm

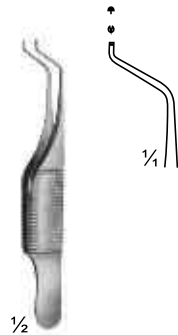

**04-251**  
GILL - HESS  
75 mm

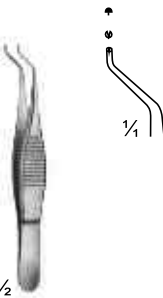

**04-252**  
HESS  
70 mm

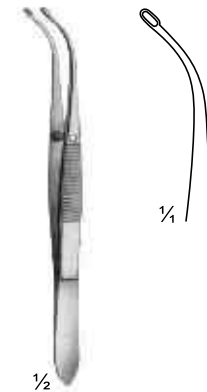

**04-253**  
ARRUGA  
100 mm

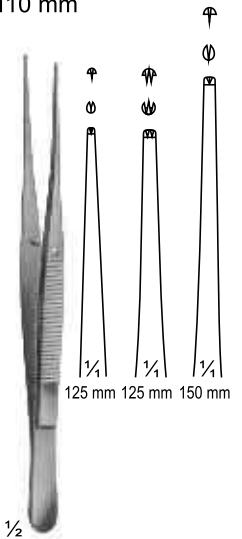

**04-254**  
SEMKEN

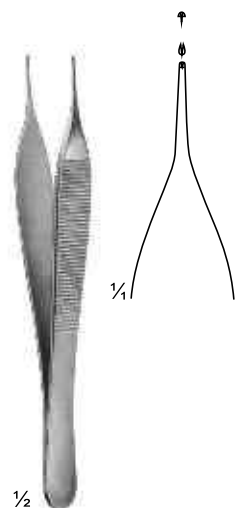

**04-255**  
MICRO-ADSON  
120 mm

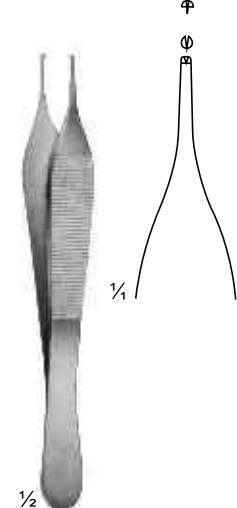

**04-256**  
ADSON  
120 mm

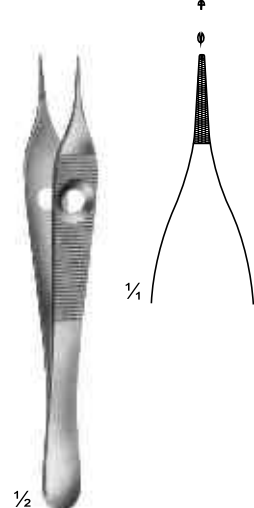

**04-257**  
ADSON  
120 mm



**04-258**  
ADSON  
120 mm

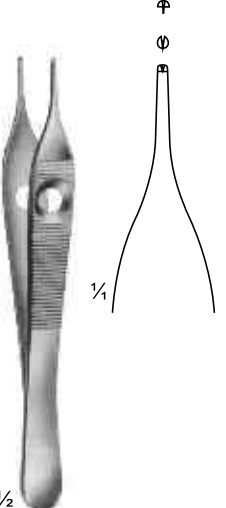

**04-259**  
ADSON  
150 mm



# Tissue Forceps

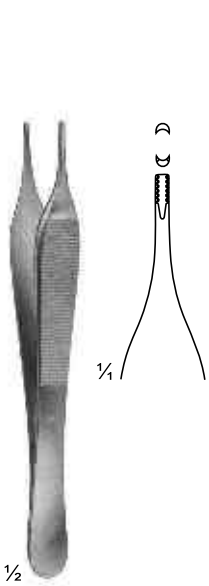

**04-260**  
**ADSON - BROWN**  
Non-traumatic  
120 mm

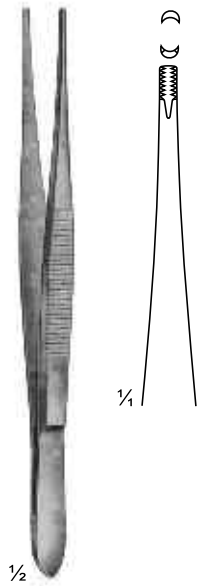

**04-261**  
**BROWN**  
120 mm

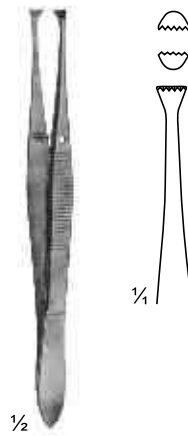

**04-262**  
**GRAEFE**  
110 mm

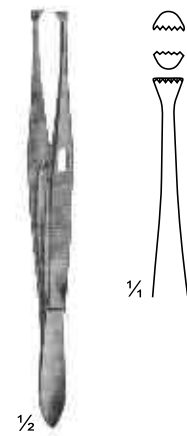

**04-263**  
**GRAEFE**  
With Catch  
110 mm

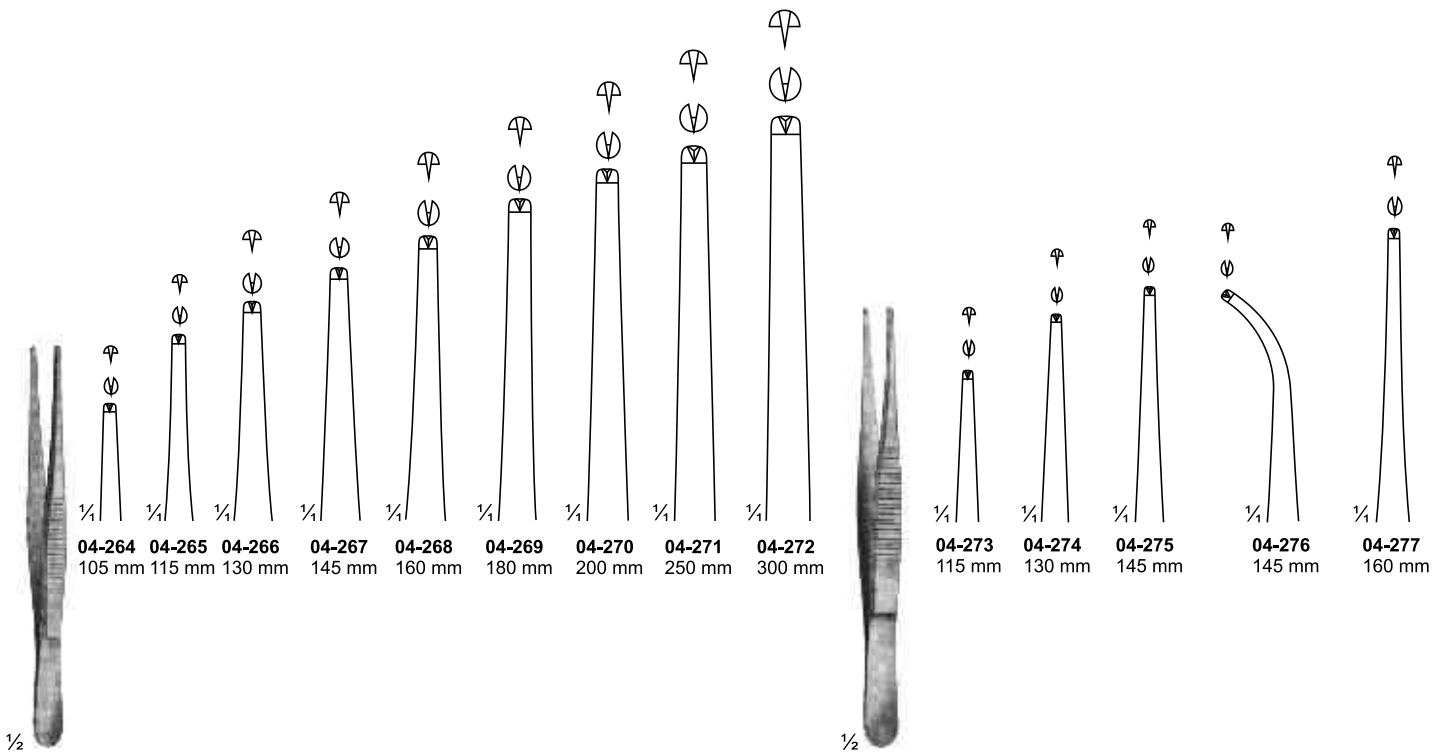

**04-264 - 272**  
**STANDARD**

**04-273 - 277**  
**GRAEFE**  
110 mm

# Tissue Forceps

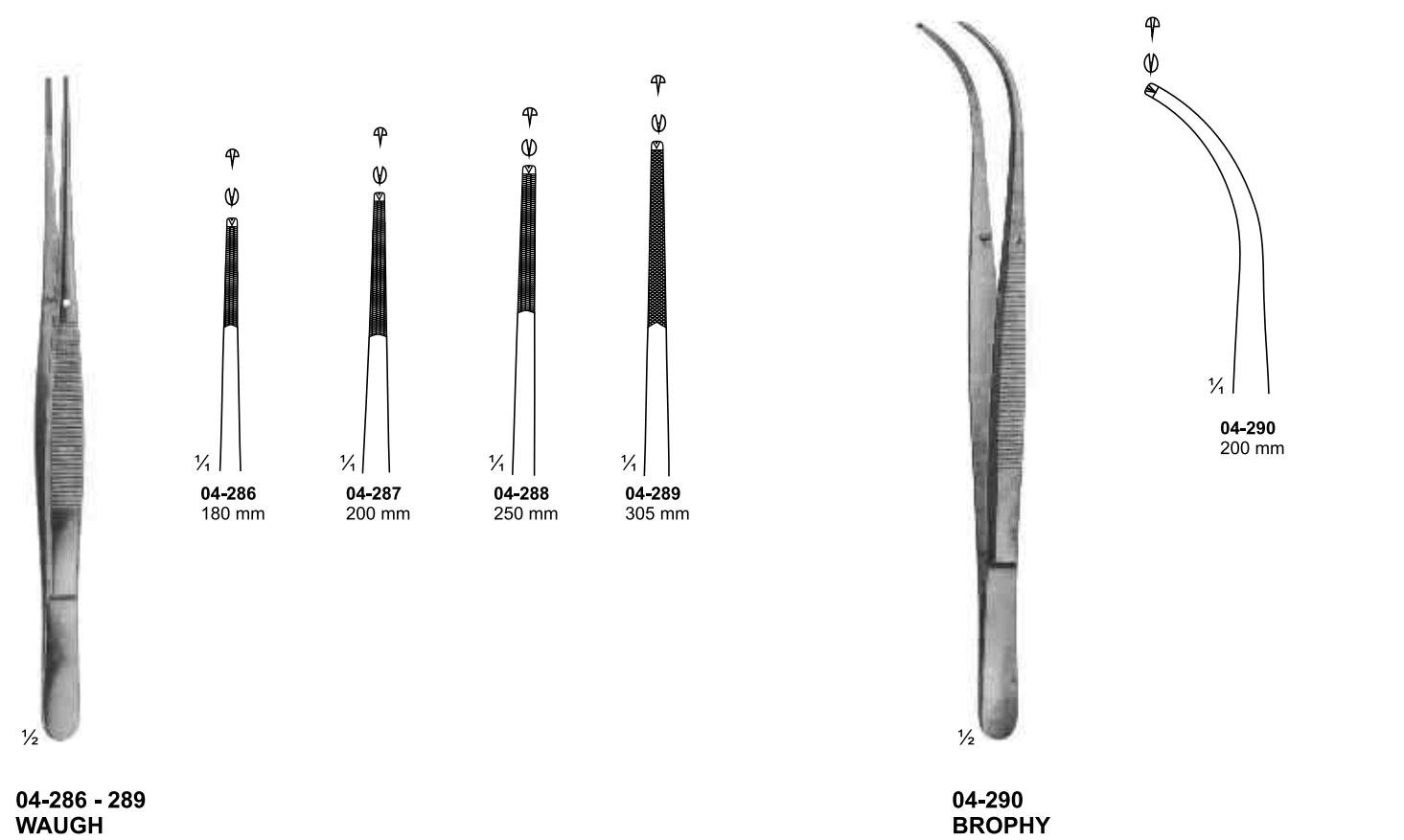
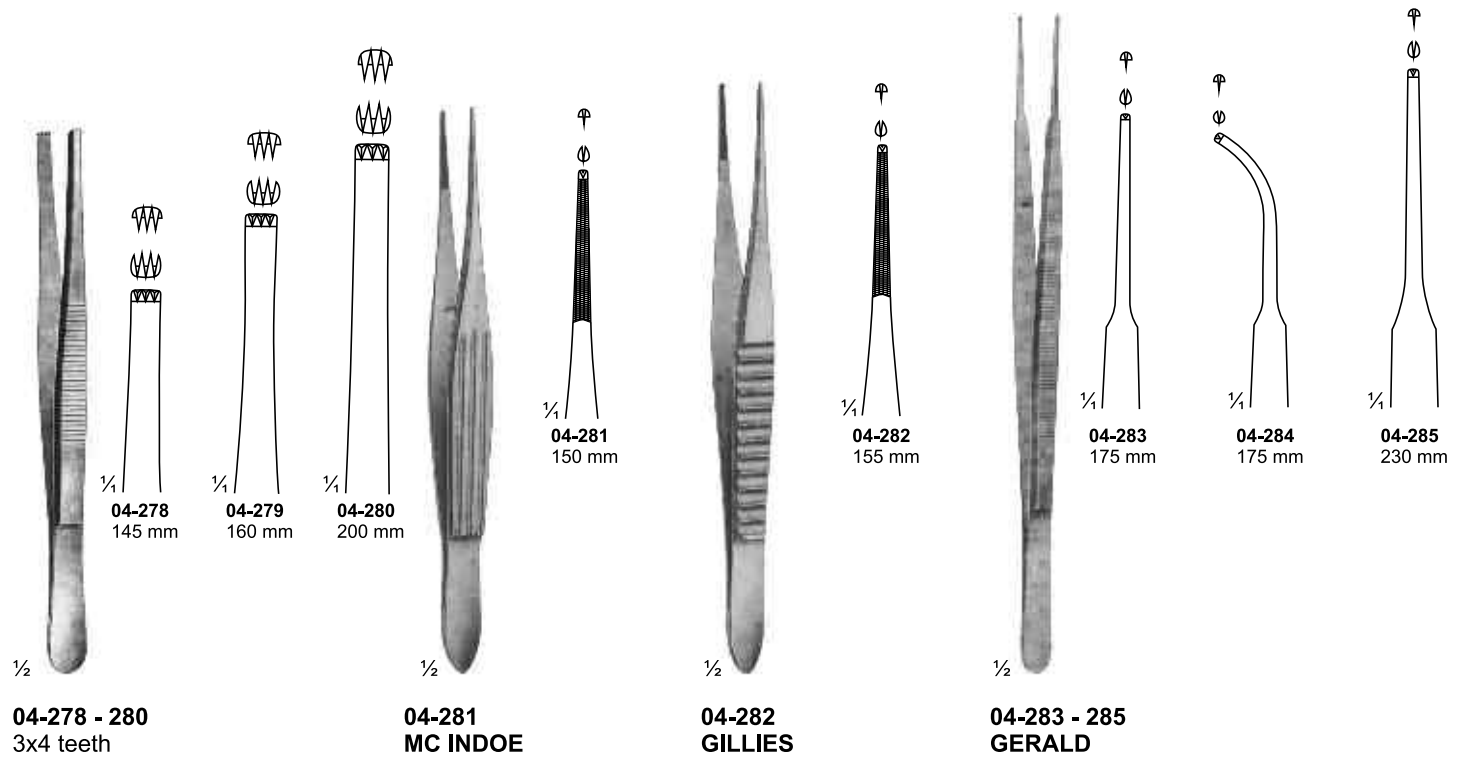

# Tissue Forceps, Lung Dissecting Forceps

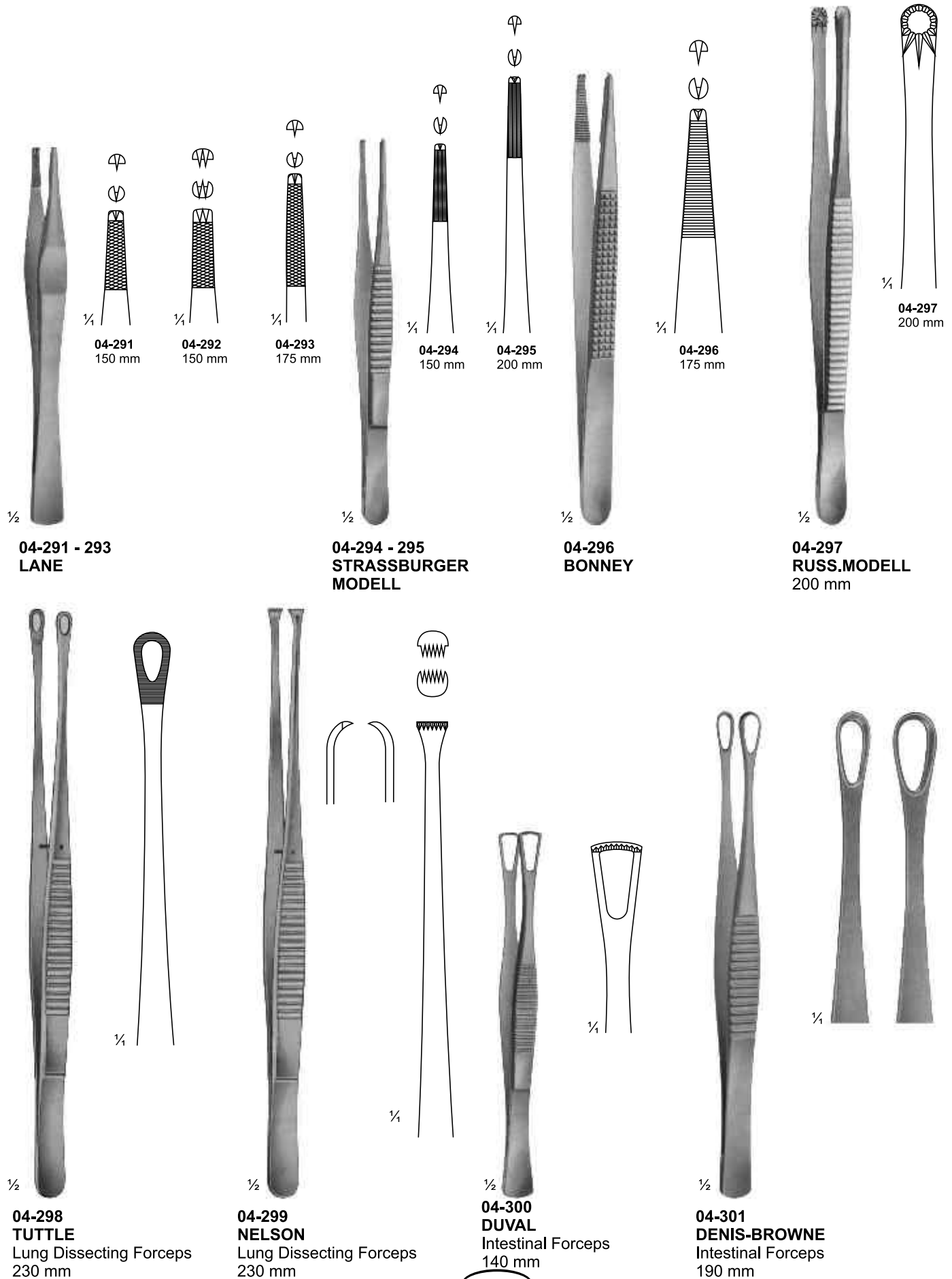

# Splinter and Cilia Forceps

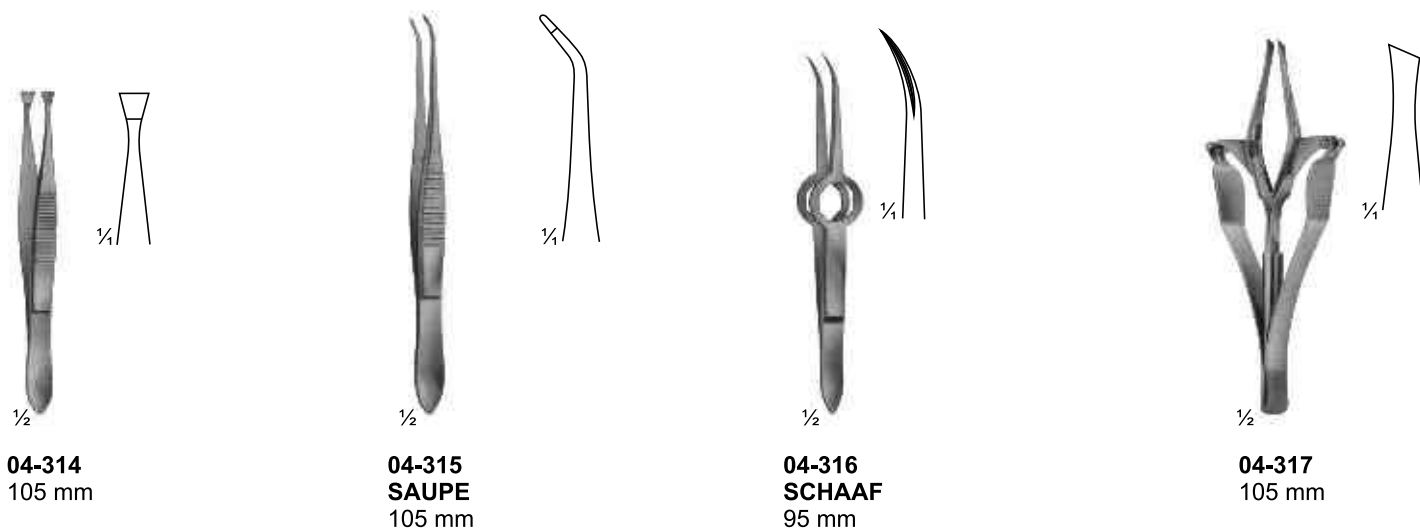
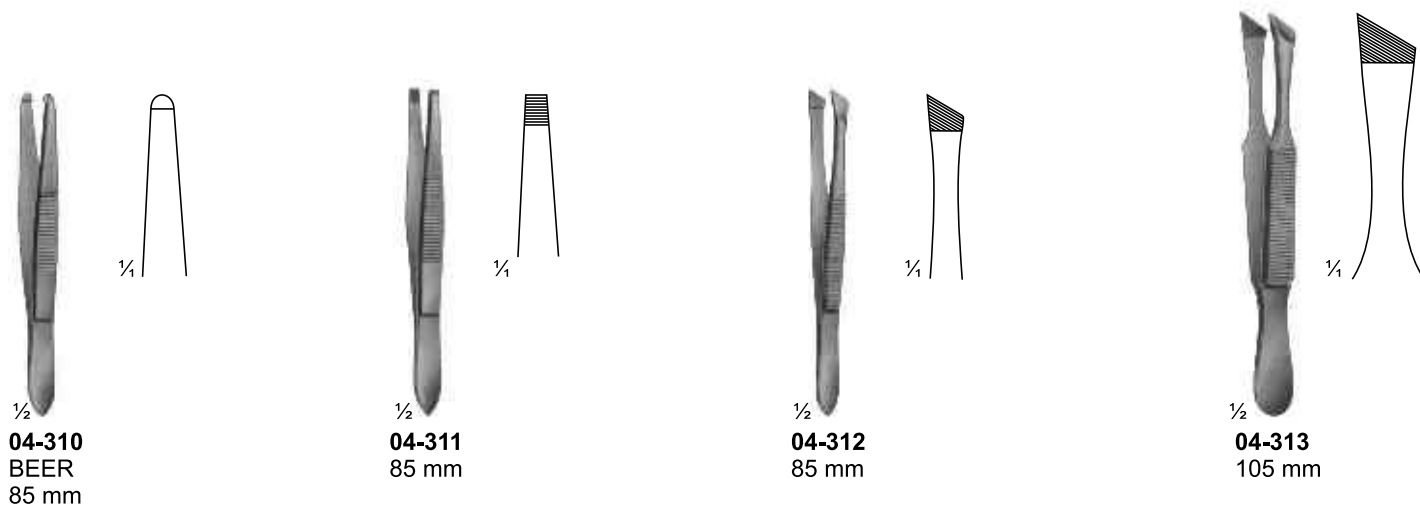
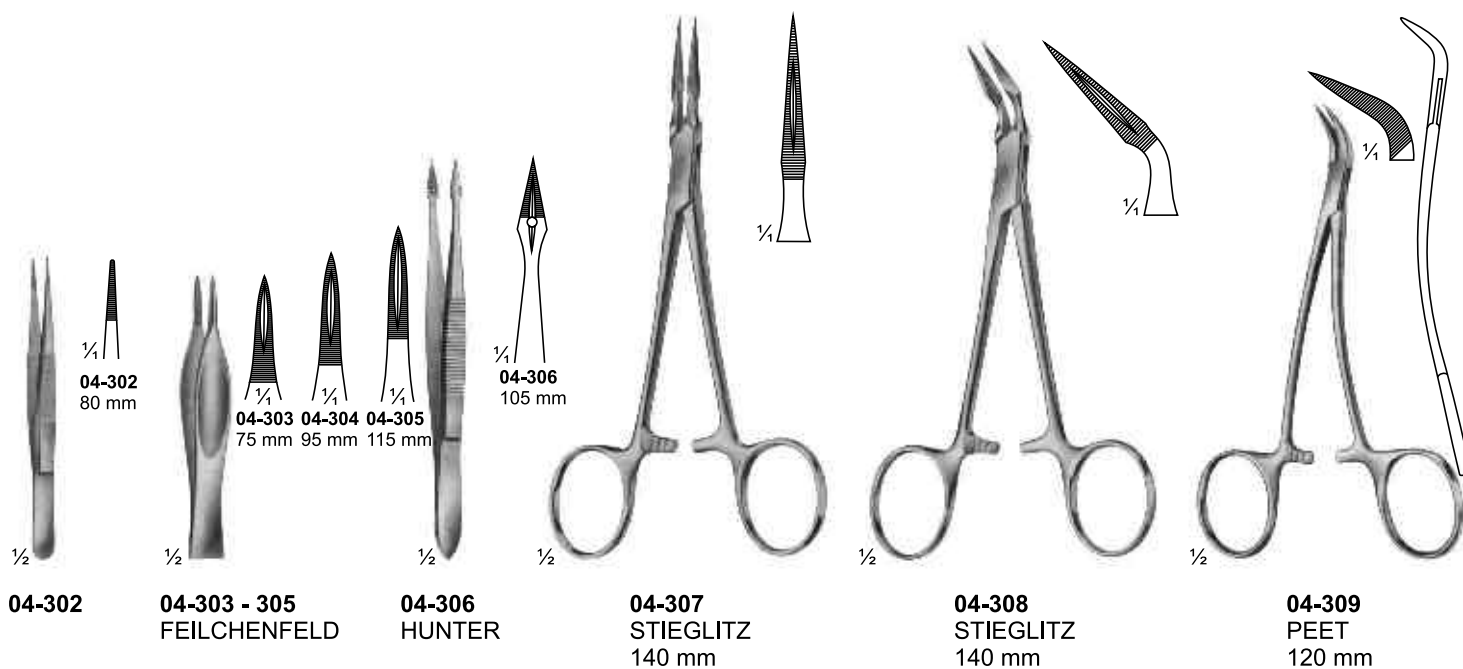

# Sponge and Dressing Forceps

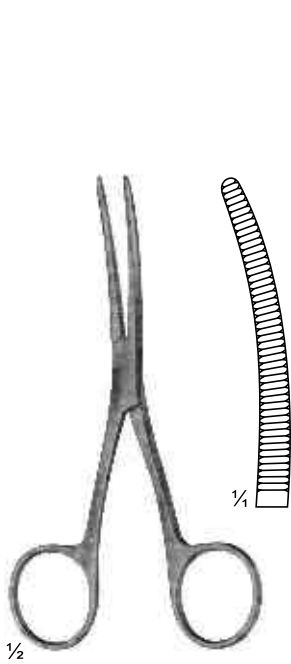

**04-318**  
BRYANT  
130 mm

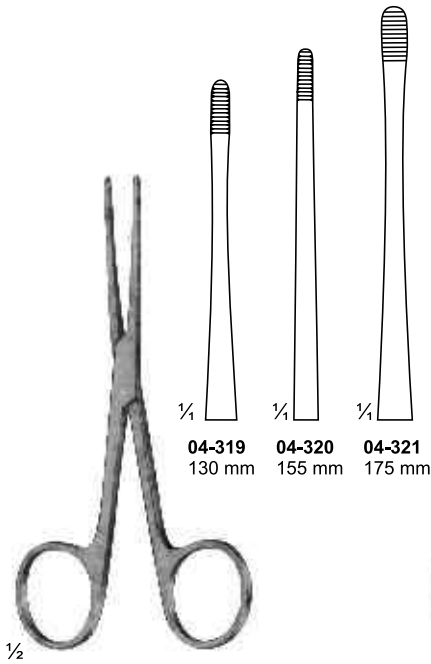

**04-319 - 321**  
LISTER  
Sinus Forceps

**04-319** 130 mm  
**04-320** 155 mm  
**04-321** 175 mm

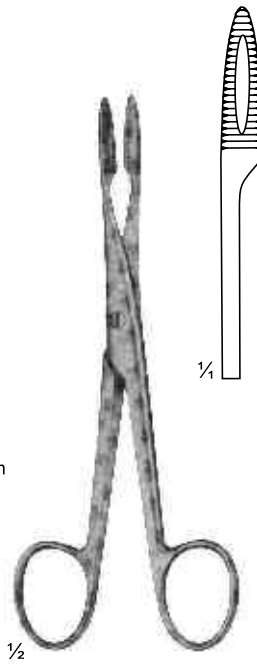

**04-322**  
Without Ratchet  
145 mm

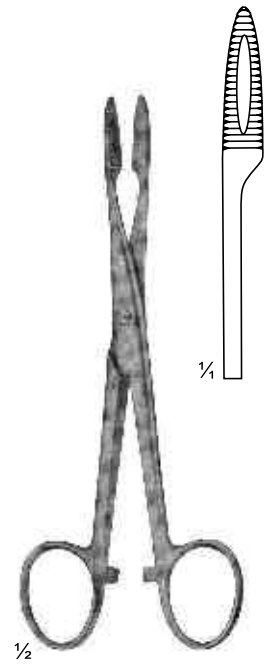

**04-323**  
With Ratchet  
145 mm

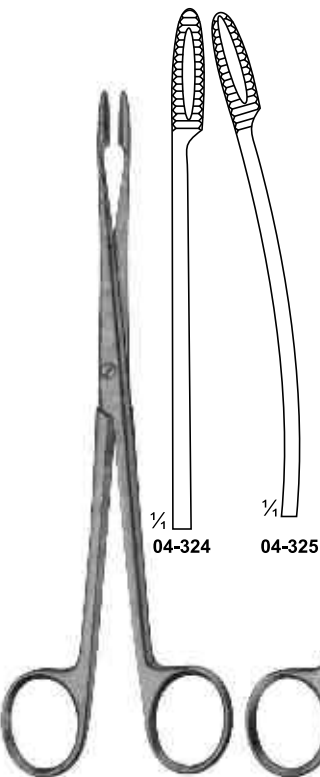

**04-324 - 325**  
GROSS  
Without Ratchet  
200 mm

**04-324**  
**04-325**

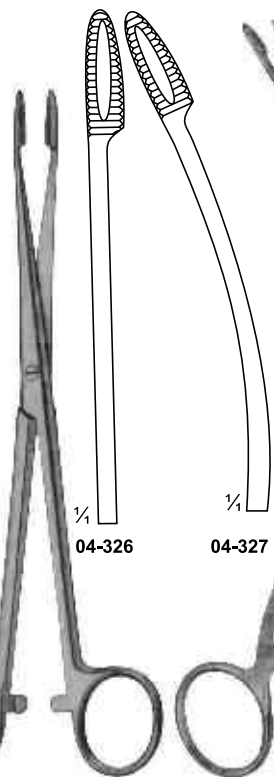

**04-326 - 327**  
GROSS  
With Ratchet  
180 mm

**04-326**  
**04-327**

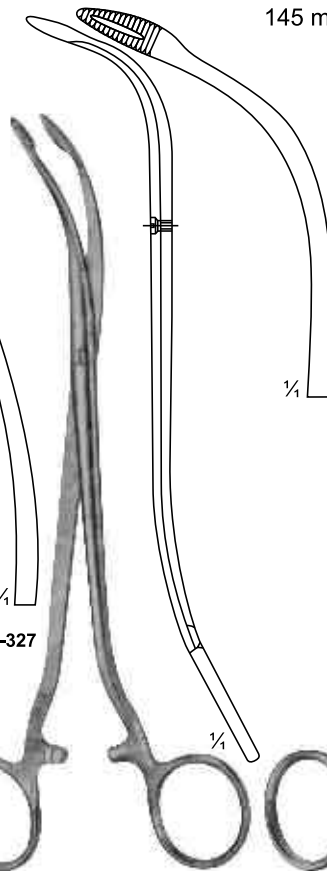

**04-328**  
DUPLAY  
190 mm

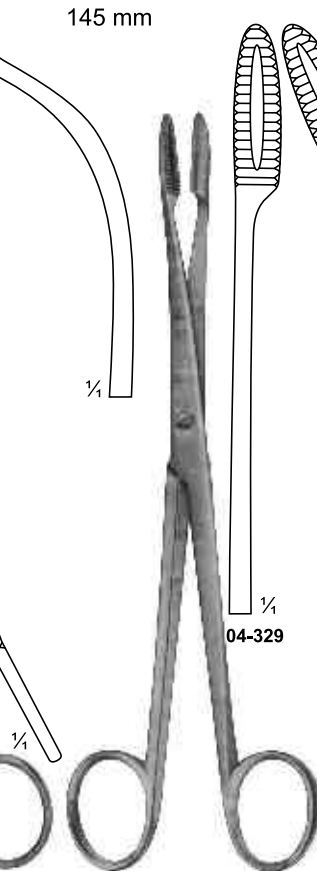

**04-329 - 330**  
GROSS  
Without Ratchet  
200 mm

**04-329**  
**04-330**

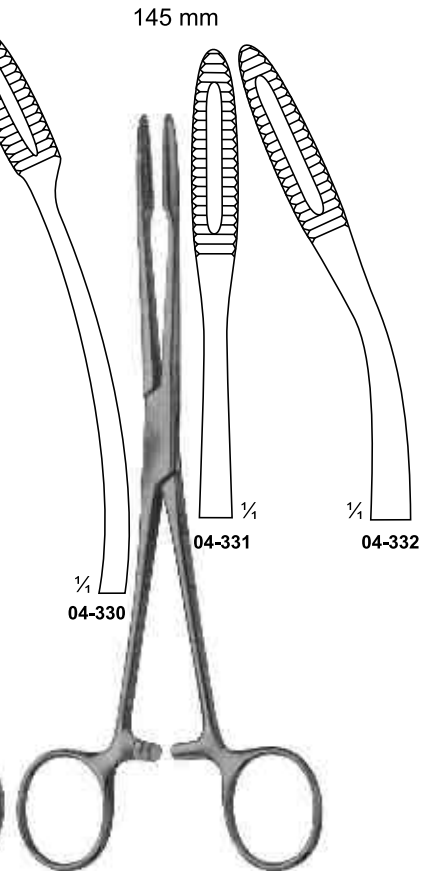

**04-331 - 332**  
GROSS  
With Ratchet  
200 mm

**04-331**  
**04-332**

# Sponge and Dressing Forceps



**04-333 - 334**  
**AESCULAP**  
 220 mm

**04-335 - 336**  
**MAIER**  
 Without Ratchet  
 265 mm

**04-337 - 338**  
**MAIER**  
 With Ratchet  
 265 mm

# Sponge and Dressing Forceps

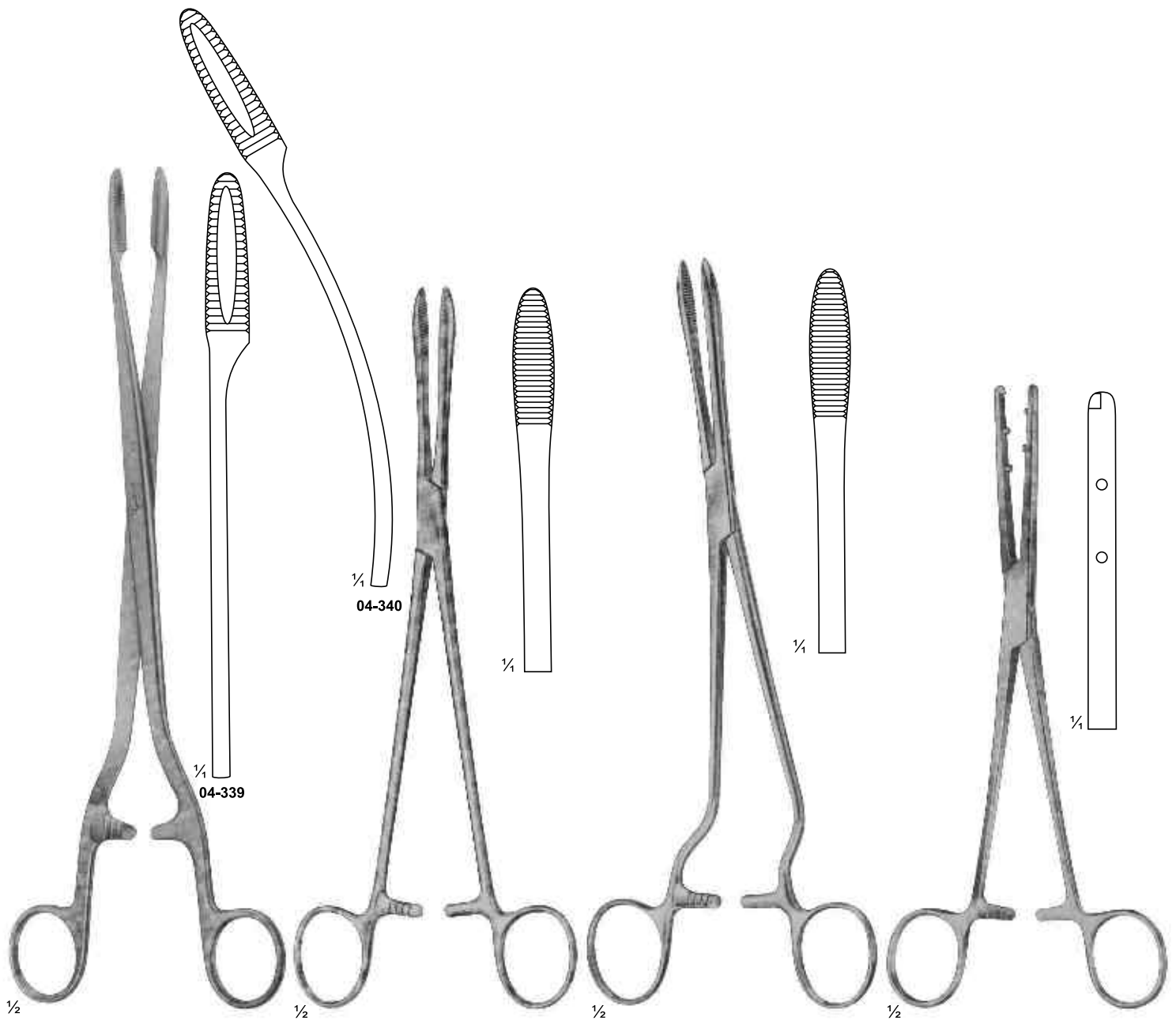

**04-339 - 340**  
SIMS-MAIER  
280 mm

**04-341**  
COLLIN  
240 mm

**04-342**  
CHERON  
Handles Laterally Angled  
240 mm

**04-343**  
EMMET  
210 mm

# Dressing, Sponge holding, Organ and Tissue Grasping Forceps

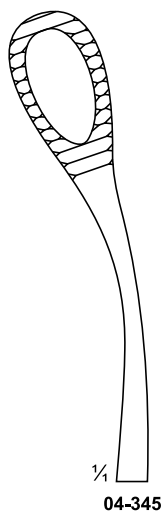
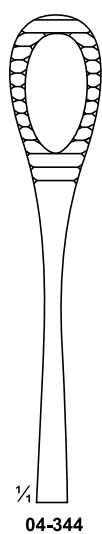
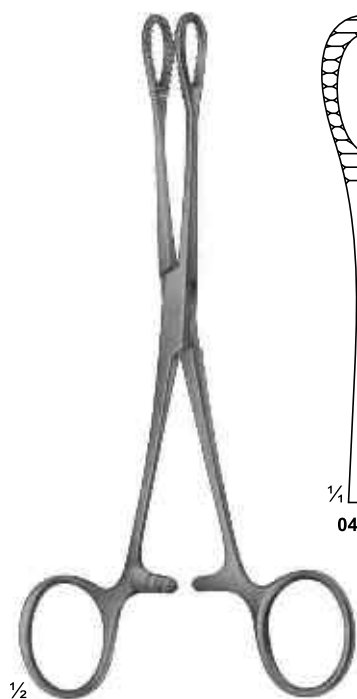

**04-344 - 345**  
FOERSTER-BALLENGER  
180 mm

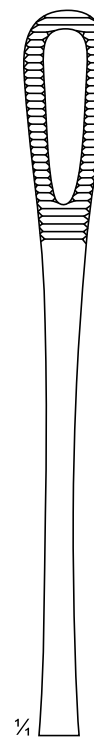
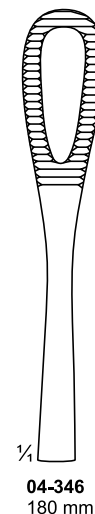

**04-346 - 347**  
RAMPLEY

**04-347**  
250 mm

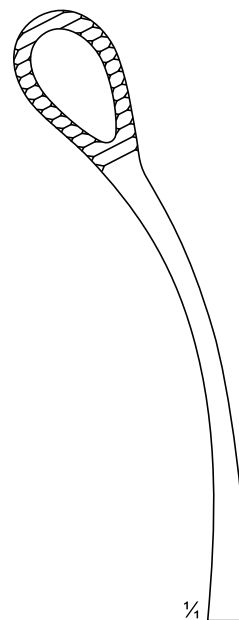
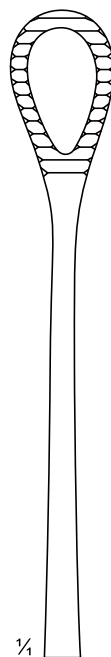
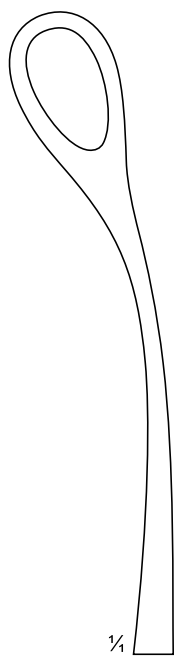
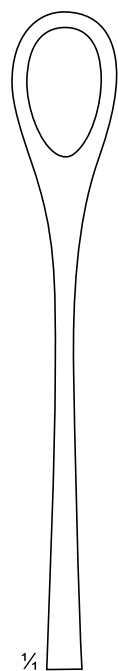
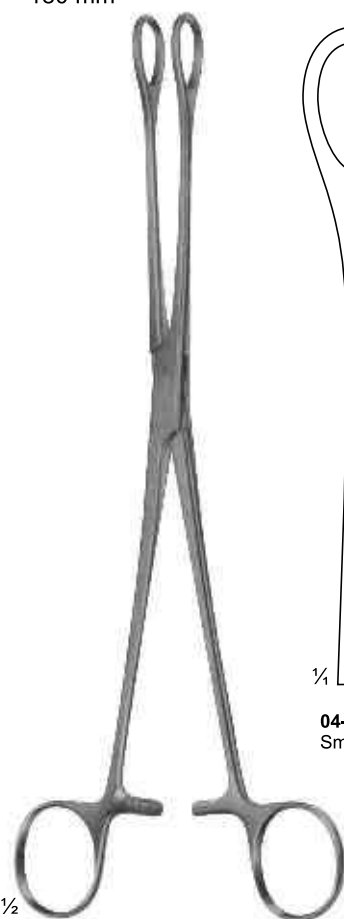

**04-348**  
Smooth Jaws

**04-349**  
Smooth Jaws

**04-350**  
Serrated Jaws

**04-351**  
Serrated Jaws

**04-348 - 351**  
FOERSTER-BALLENGER  
240 mm

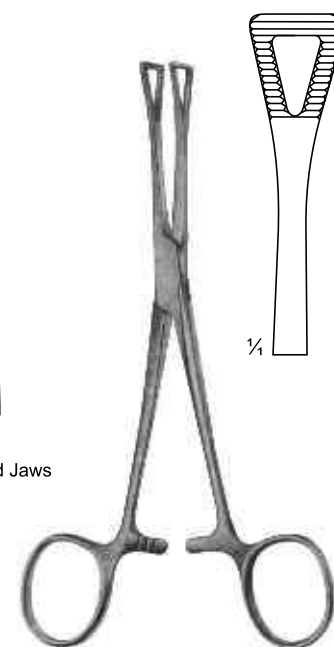

**04-352**  
PENNINGTON  
155 mm



# Dressing, Sponge holding, Organ and Tissue Grasping Forceps

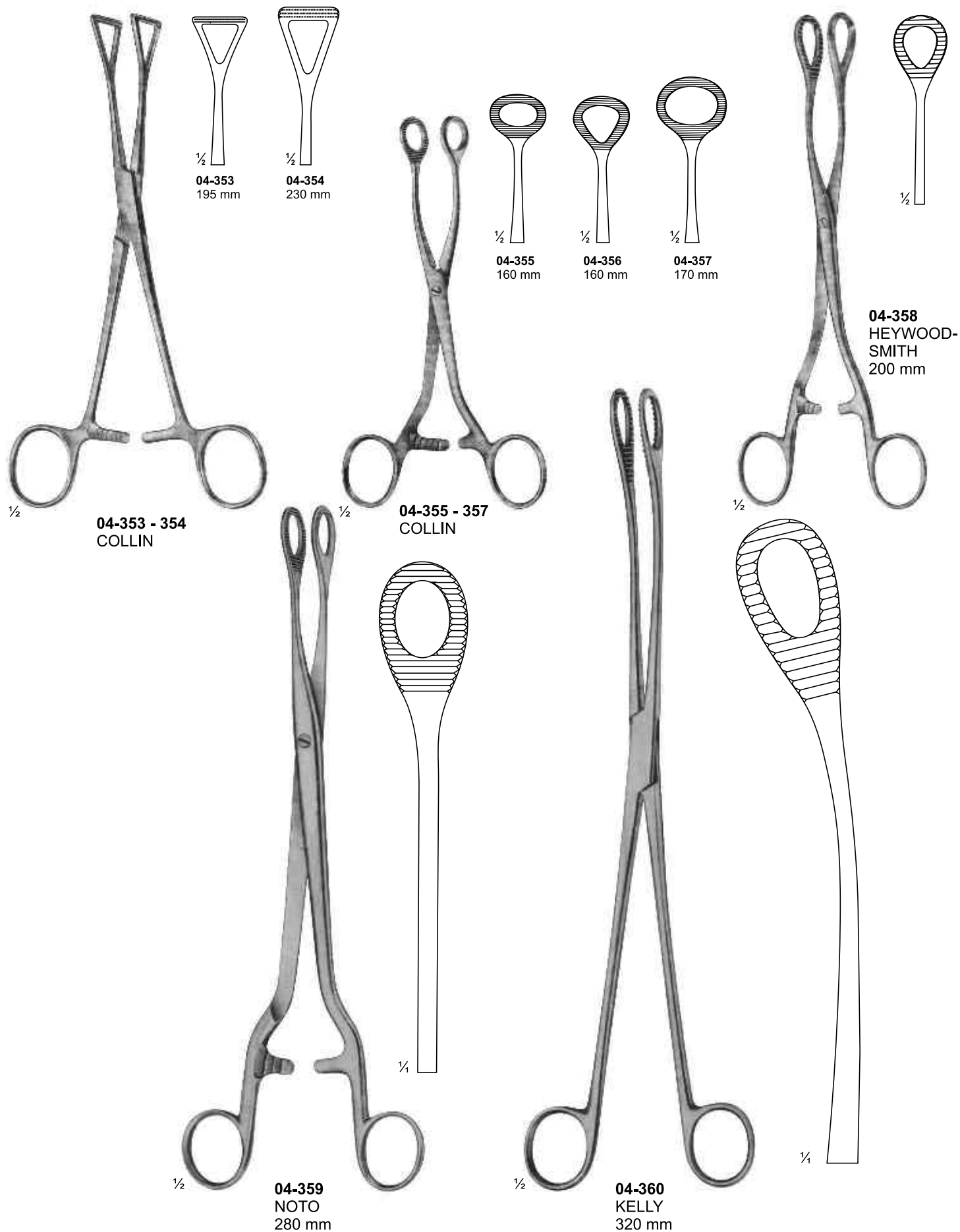

# Tendon Seizing Forceps

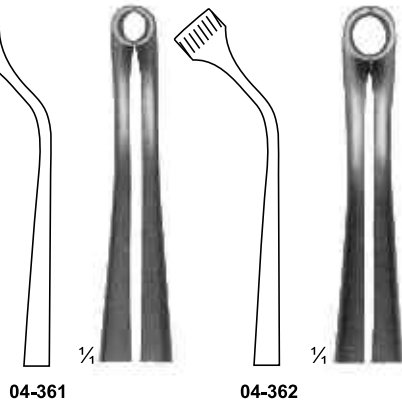
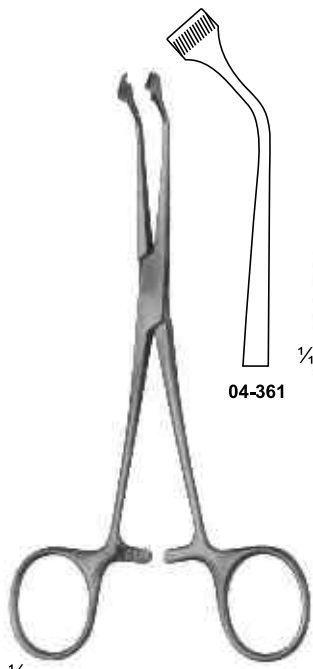

**04-361 - 362**  
HERZ  
155 mm

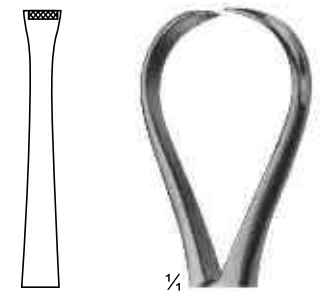

**04-363**

**04-363**  
JACKSON  
4 x 5 teeth  
150 mm

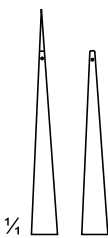
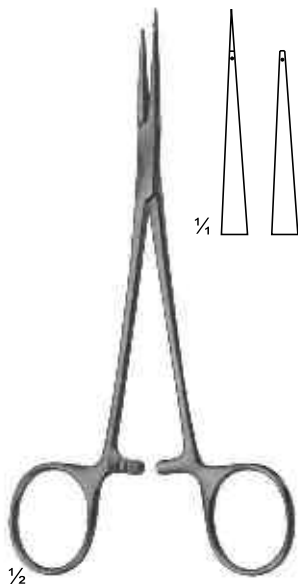

**04-364**  
150 mm

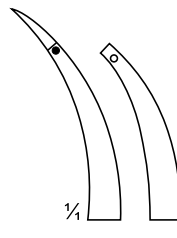
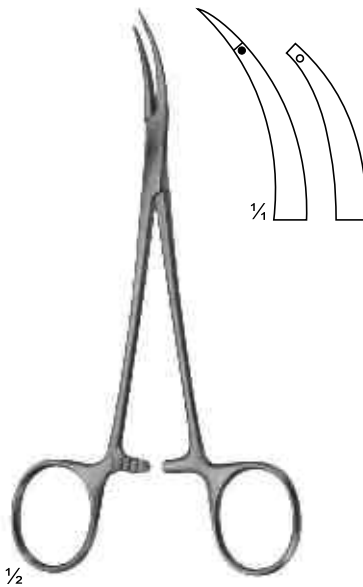

**04-365**  
150 mm

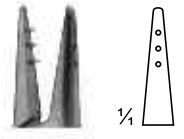

**04-366**  
120 mm

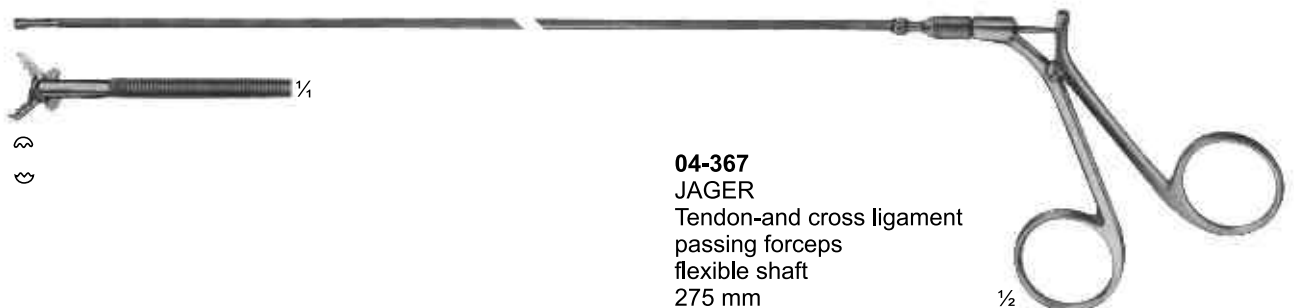

**04-367**  
JAGER  
Tendon and cross ligament  
passing forceps  
flexible shaft  
275 mm

# Artery Traction - and Tissue Grasping Forceps

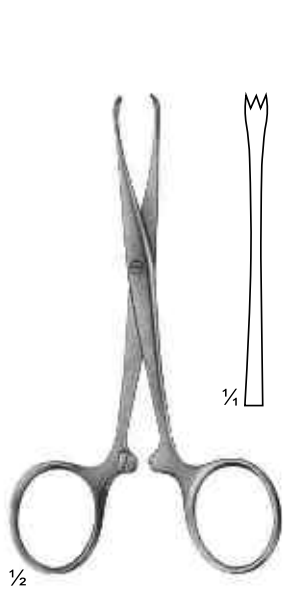

**04-368**  
**CHAPUT**  
 2 x 3 teeth  
 125 mm

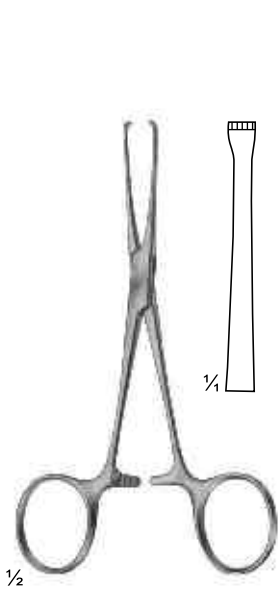

**04-369**  
**BABY-ALLIS**  
 4 x 5 teeth  
 130 mm

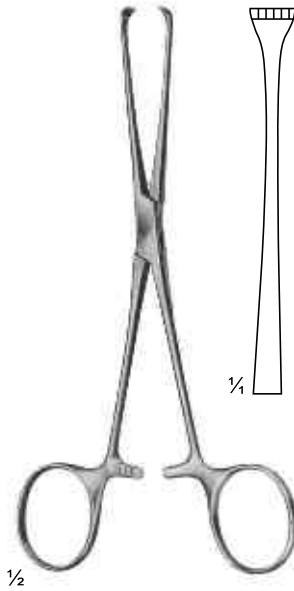

**04-370**  
**BOYS-ALLIS**  
 5 x 6 teeth  
 155 mm

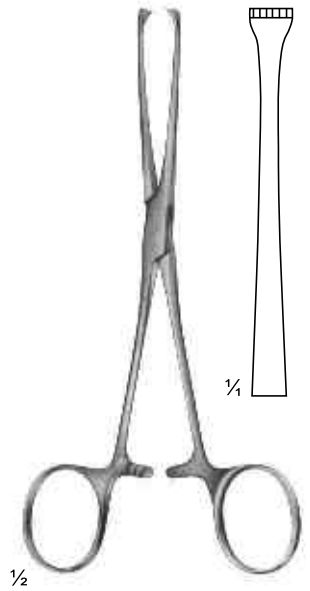

**04-371**  
**ALLIS**  
 5 x 6 teeth  
 155 mm

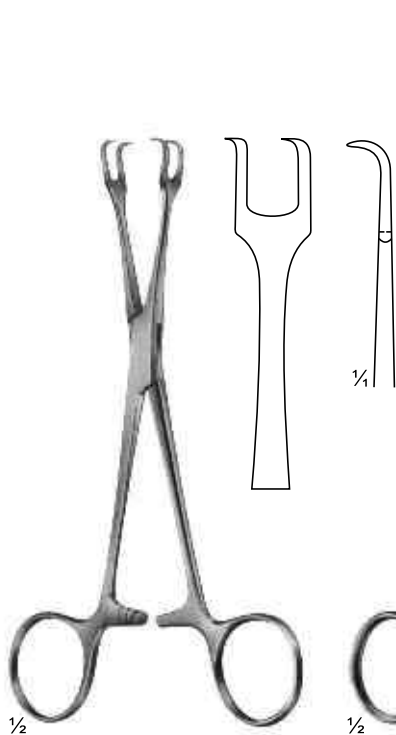

**04-372**  
**LAHEY**  
 135 mm

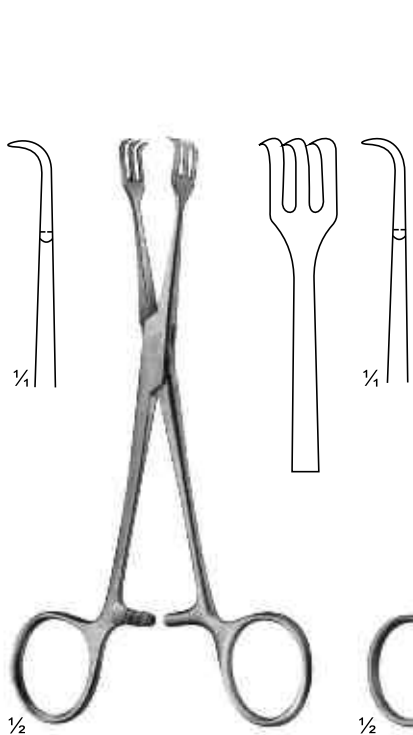

**04-373**  
**LAHEY**  
 135 mm

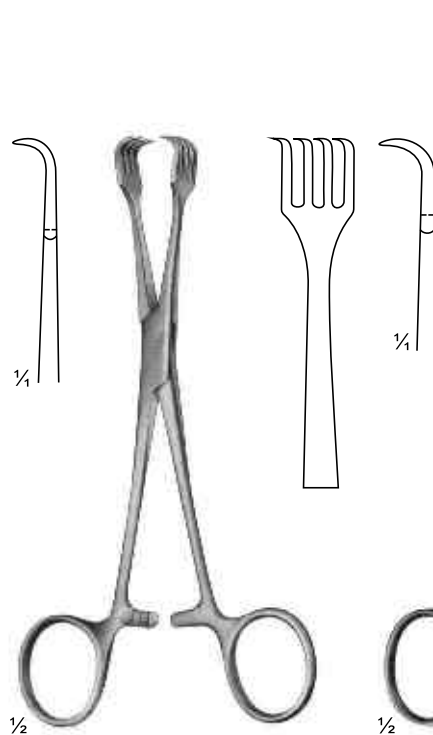

**04-374**  
**BRAUN**  
 155 mm

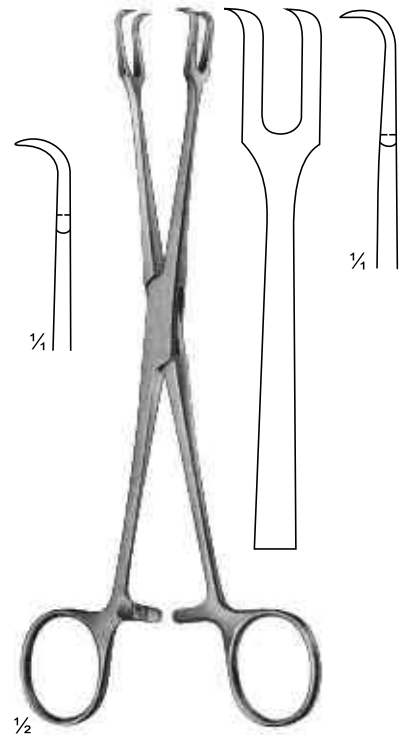

**04-375**  
**MUSEUX**  
 200 mm

# Organ - and Tissue Grasping Forceps

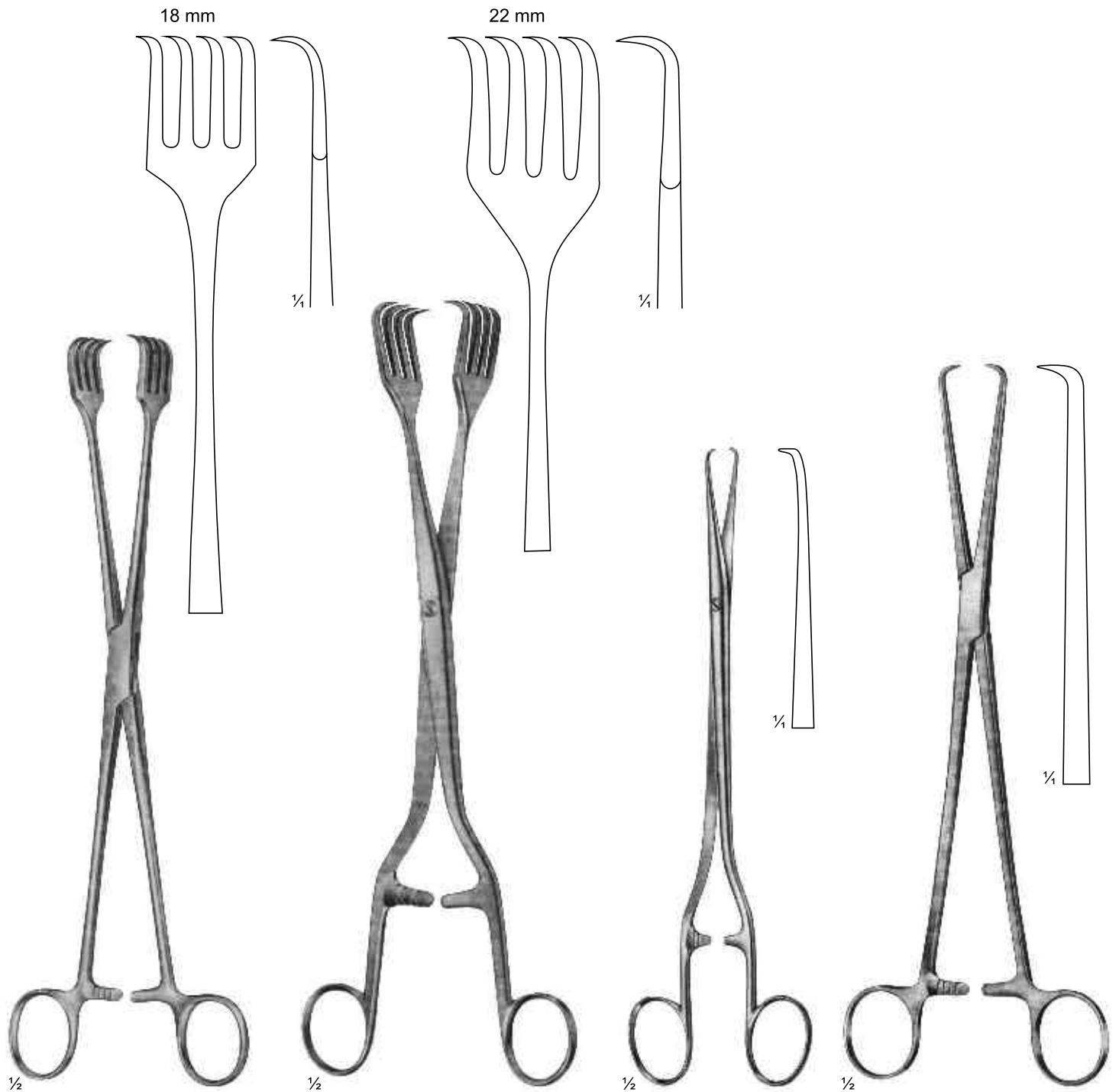

**04-376**  
AESCULAP  
260 mm

**04-377**  
PRATT  
270 mm

**04-378**  
TIEMANN  
Bullet forceps  
220 mm

**04-379**  
SCHRODER  
250 mm

# Towel Clamps

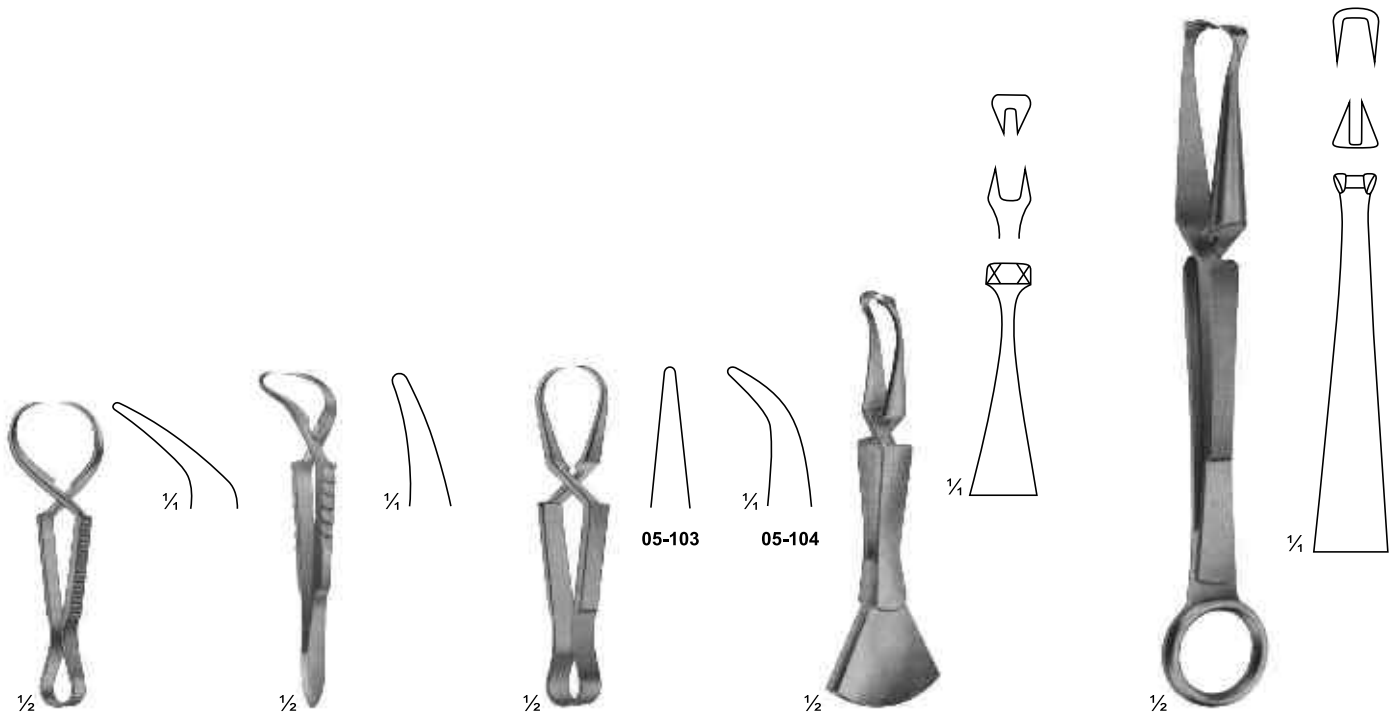

**05-101**  
JONES  
85 mm

**05-102**  
ENGL. MOD.  
85 mm

**05-103 - 104**  
SCHAEDEL  
85 mm

**05-105**  
DOYEN  
110 mm

**05-106**  
DOYEN  
180 mm

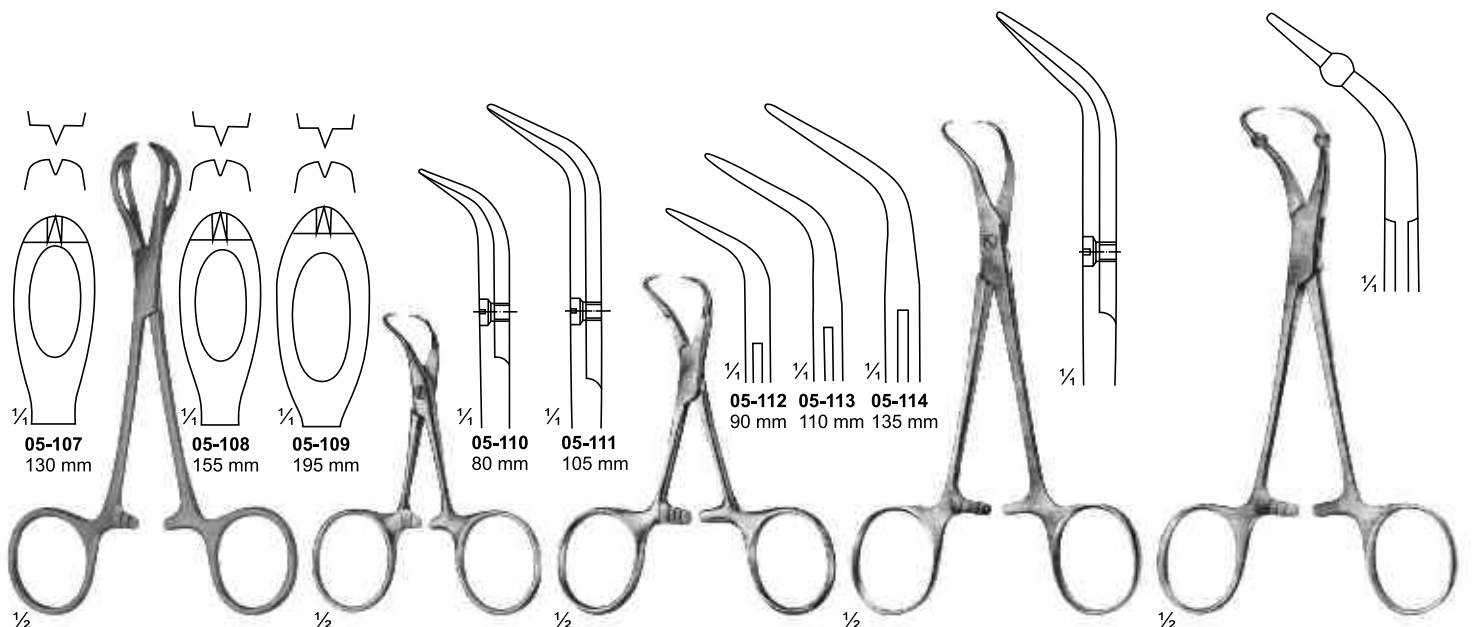

**05-107**  
130 mm

**05-108**  
155 mm

**05-109**  
195 mm

**05-110**  
80 mm

**05-111**  
105 mm

**05-112 05-113 05-114**  
90 mm 110 mm 135 mm

**05-107 - 109**  
LANE

**05-110 - 111**  
BACKHAUS

**05-112 - 114**  
BACKHAUS

**05-115**  
BACKHAUS-KOCHER  
135 mm

**05-116**  
ROEDER  
135 mm

# Towel Clamps

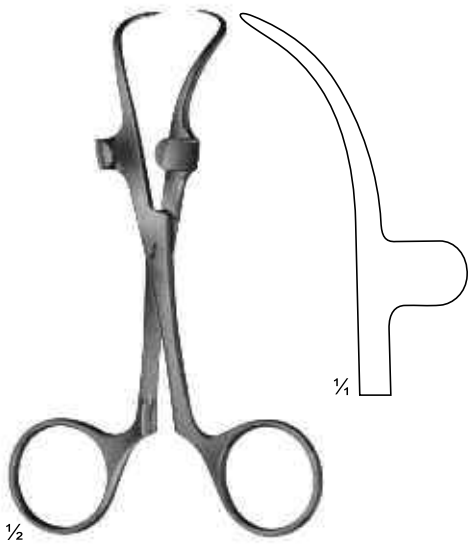

**05-117**  
**ROBIN**  
 with holders for tubing  
 up to 13 mm  
 135 mm

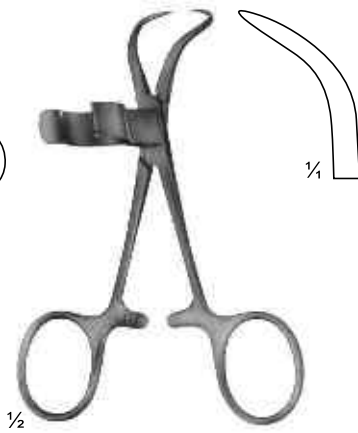

**05-118**  
 with clip for tubing  
 up to 15 mm  
 110 mm

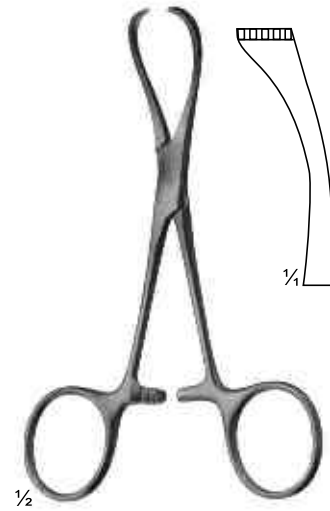

**05-119**  
**LORNA**  
 non perforating  
 130 mm

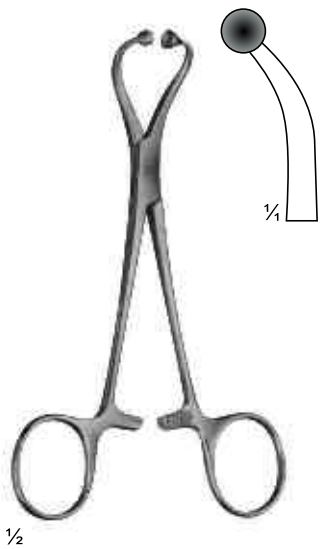

**05-120**  
 for paper cloths  
 140 mm

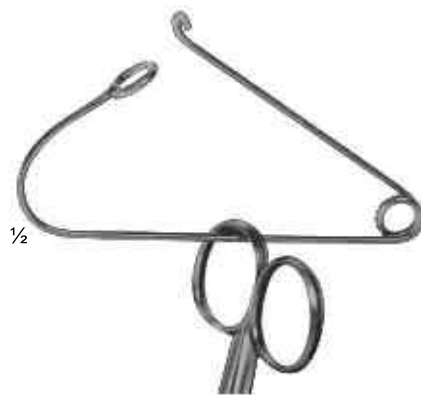

**05-121**  
**BUNT**  
 105 mm



**05-122**  
**MAYO**  
 140 mm

# Muller Vessel Clips and Bulldog Clamps

## Closing force

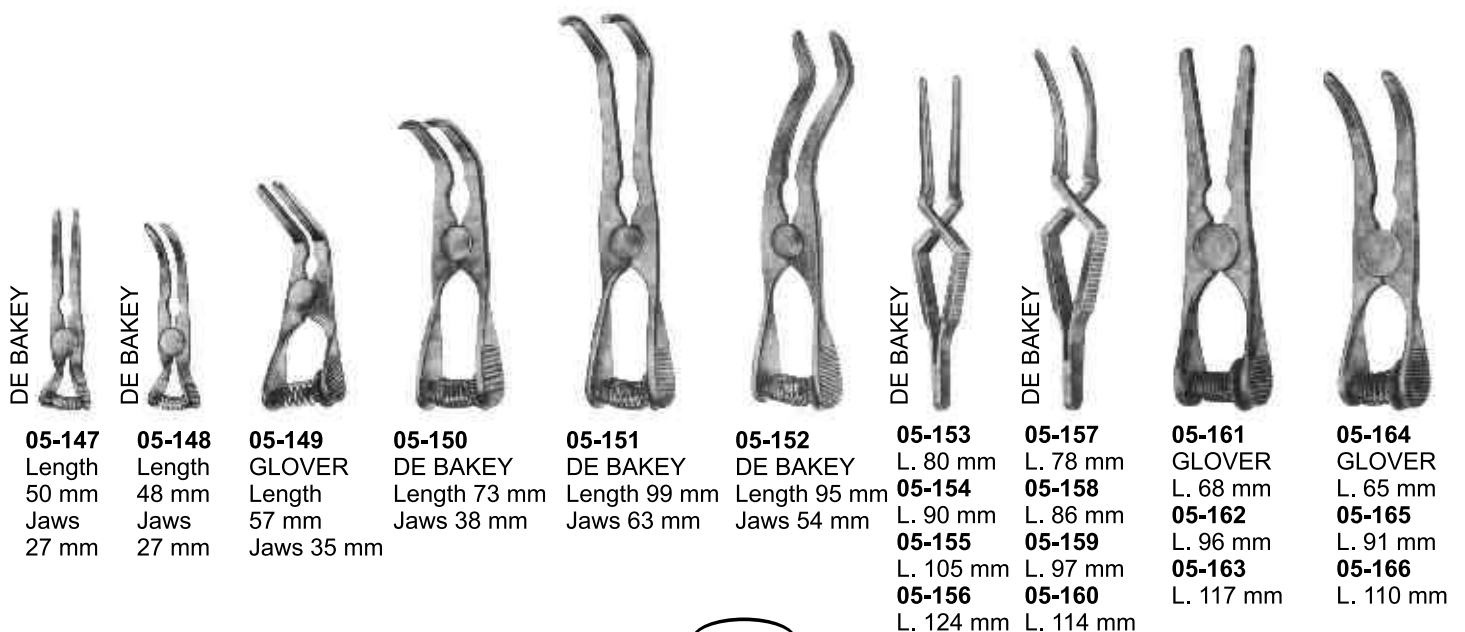
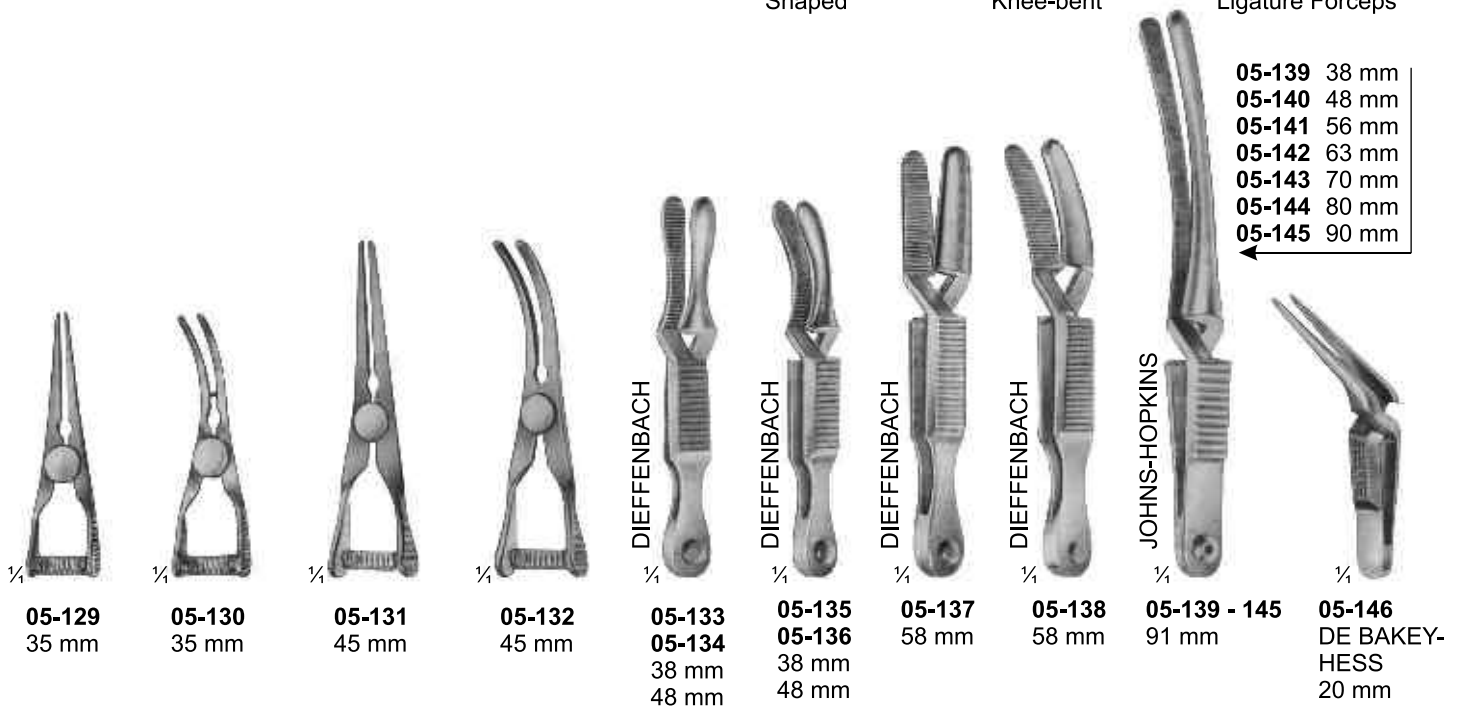
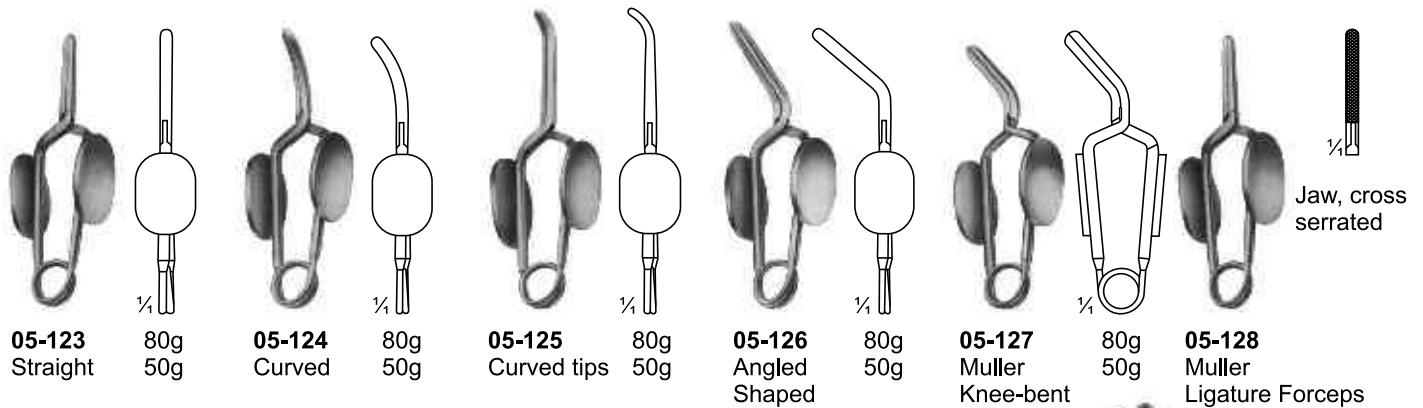

# Delicate Haemostatic Forceps

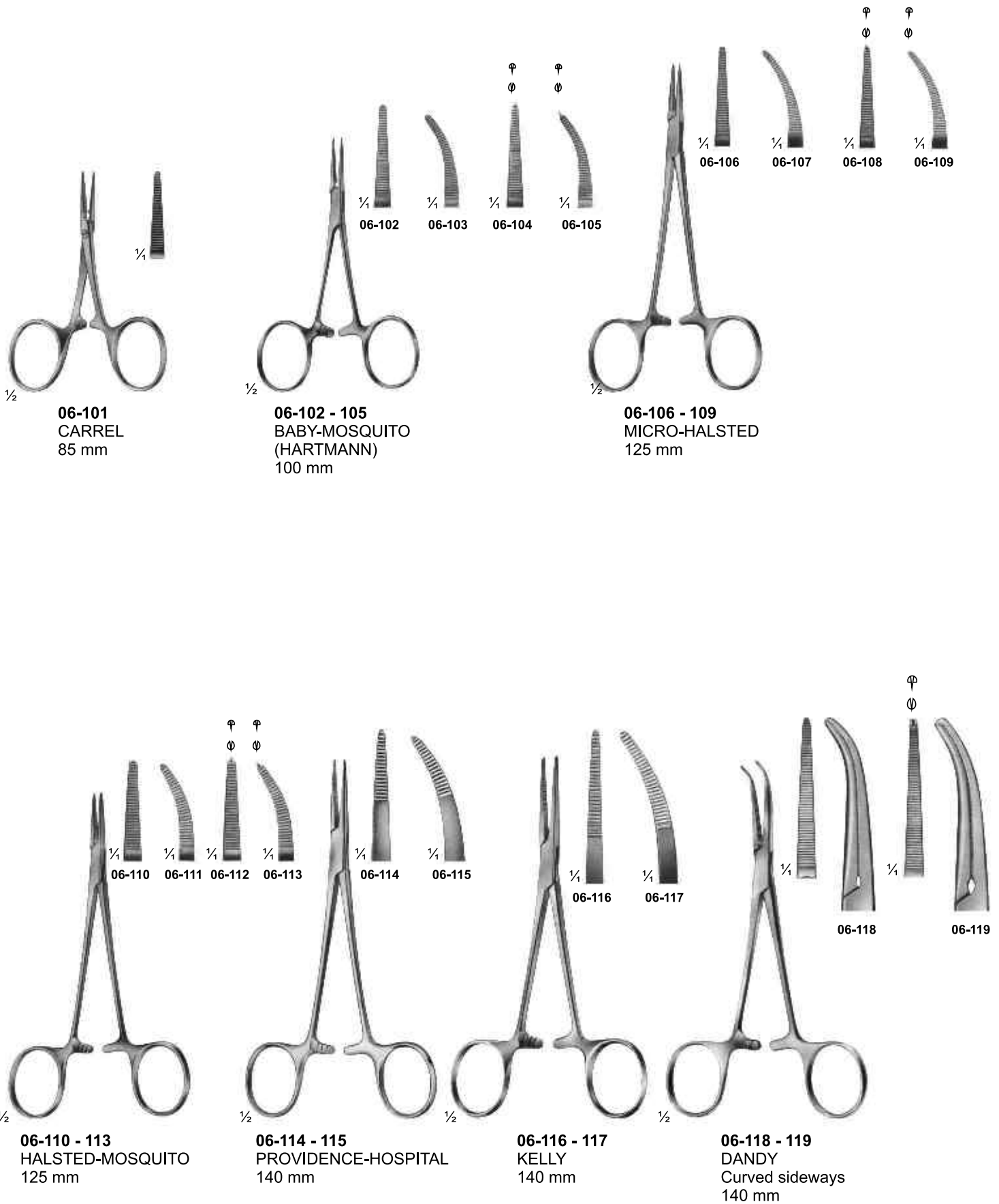



# Delicate Haemostatic Forceps

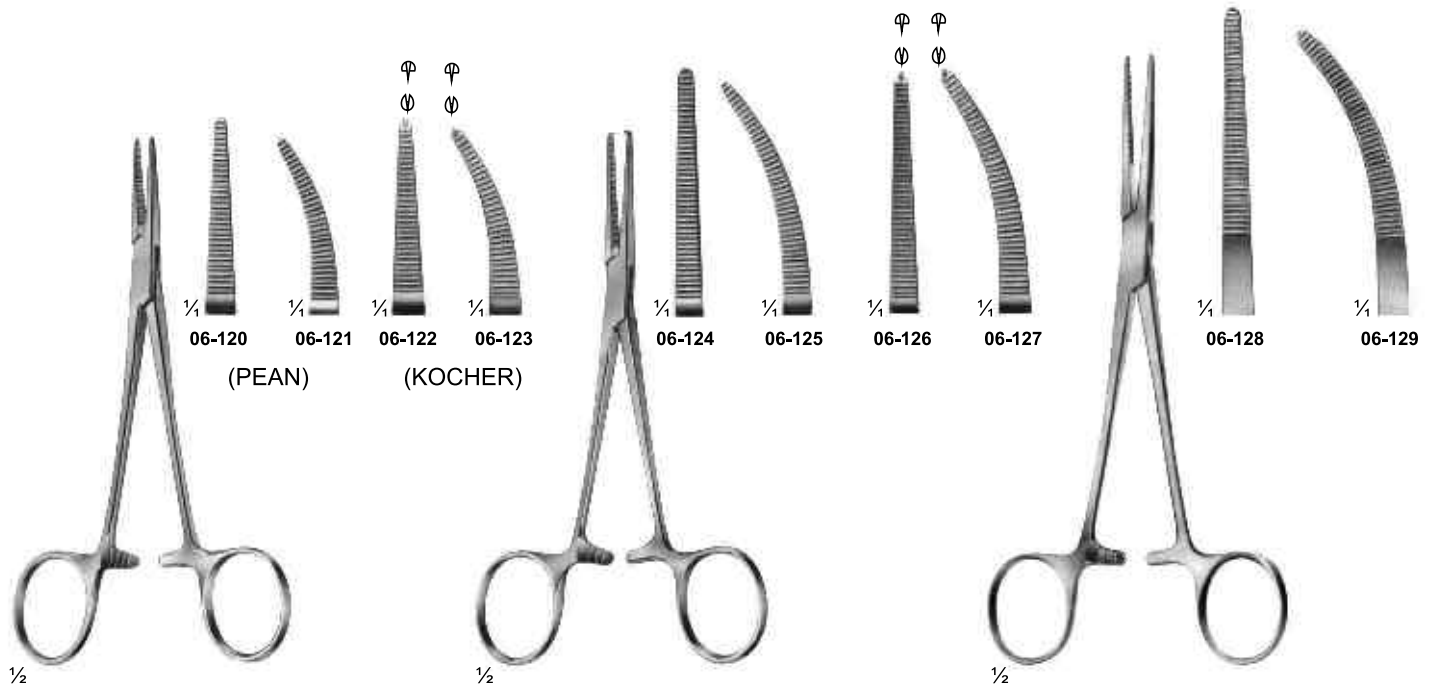

**06-120 - 123**  
BABY-CRILE  
140 mm

**06-124 - 127**  
CRILE  
140 mm

**06-128 - 129**  
RANKIN  
160 mm

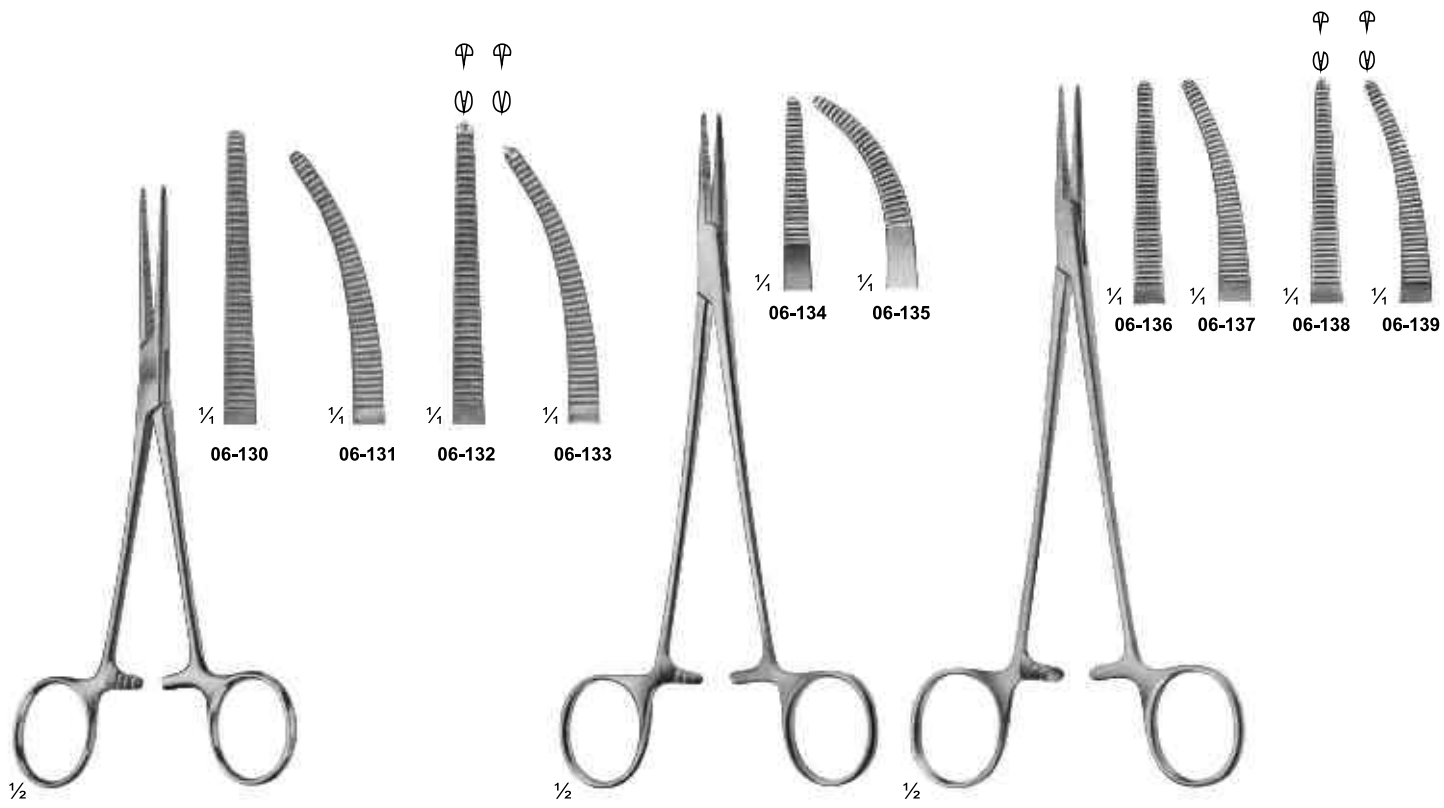

**06-130 - 133**  
CRILE  
160 mm

**06-134 - 135**  
ADSON  
185 mm

**06-136 - 139**  
HALSTED  
185 mm

# Delicate Haemostatic Forceps

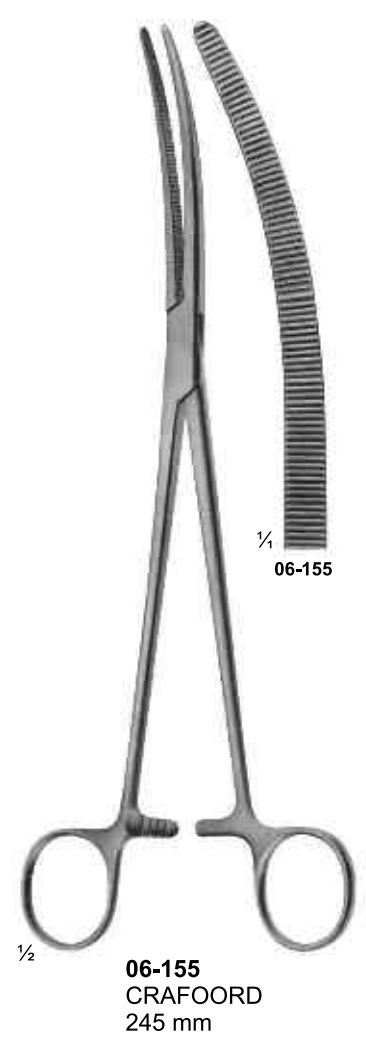
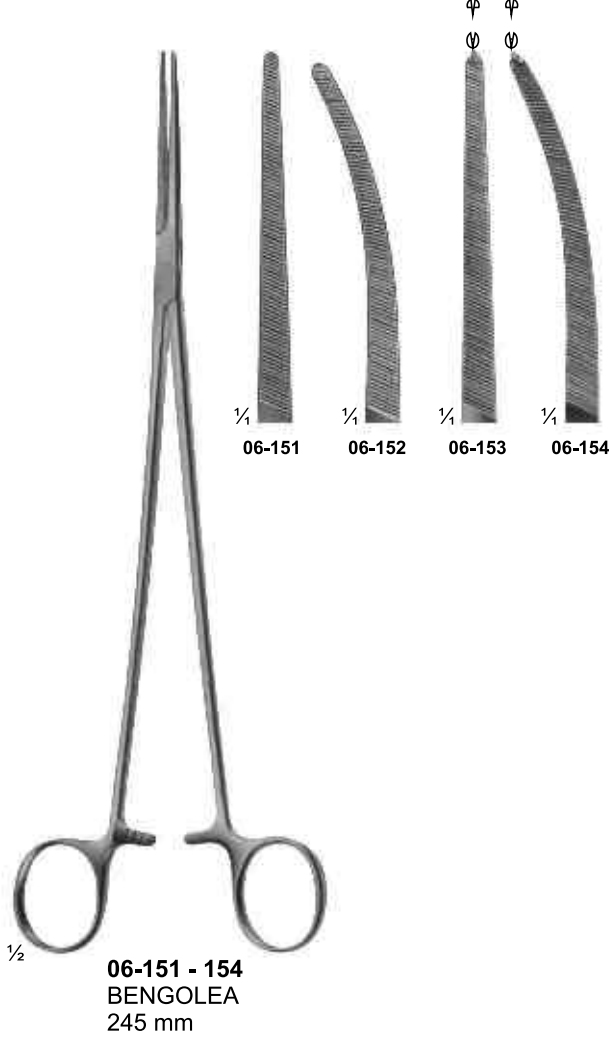
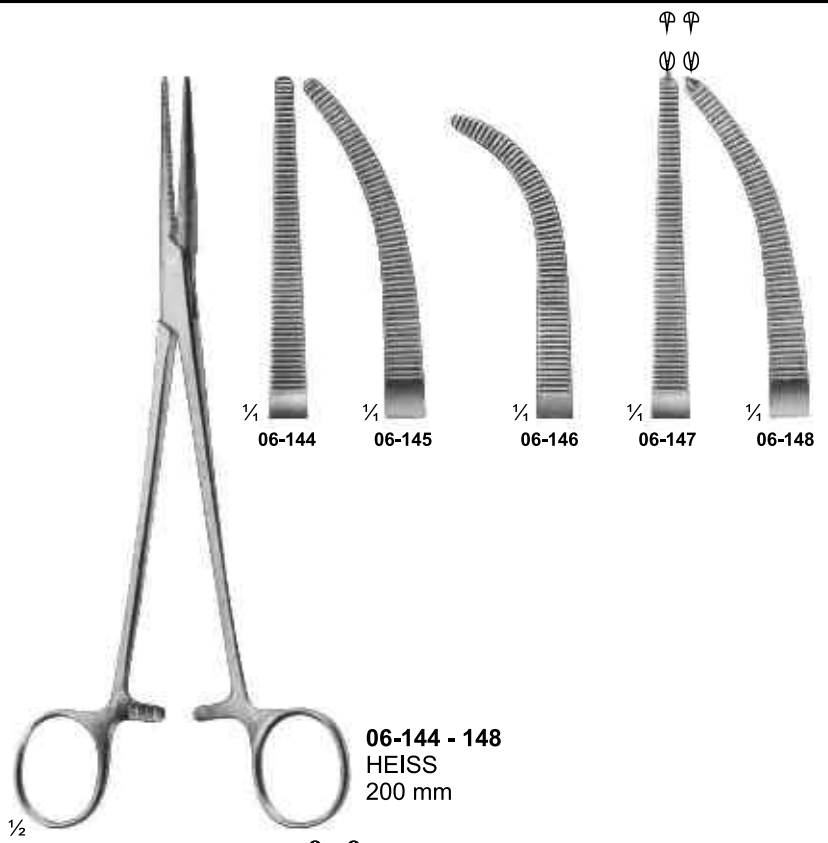
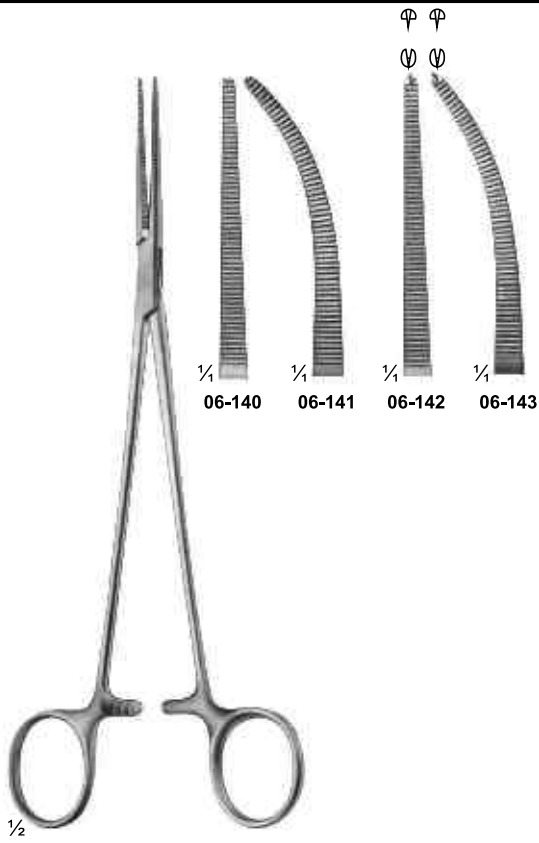

# Haemostatic Forceps

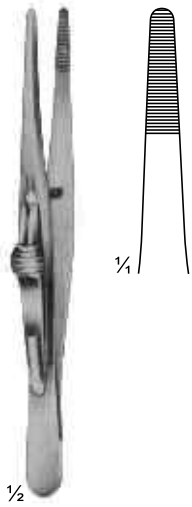

**06-156**  
FRICKE  
Artery forceps  
130 mm

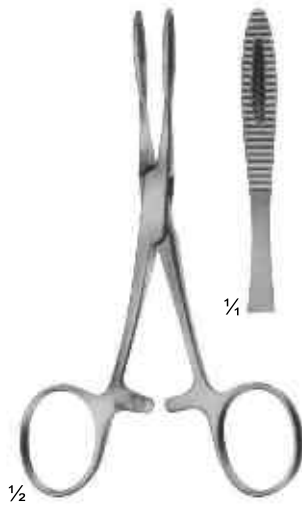

**06-157**  
KRONLEIN  
130 mm

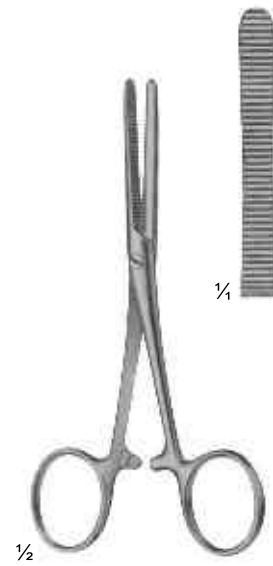

**06-158**  
PEAN  
125 mm



**06-159 - 160**  
PEAN

**06-159**  
125 mm

**06-160**  
140 mm

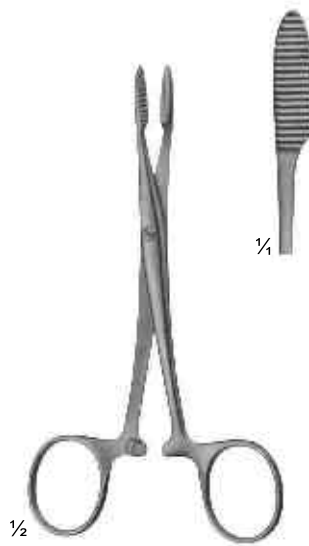

**06-161**  
PEAN

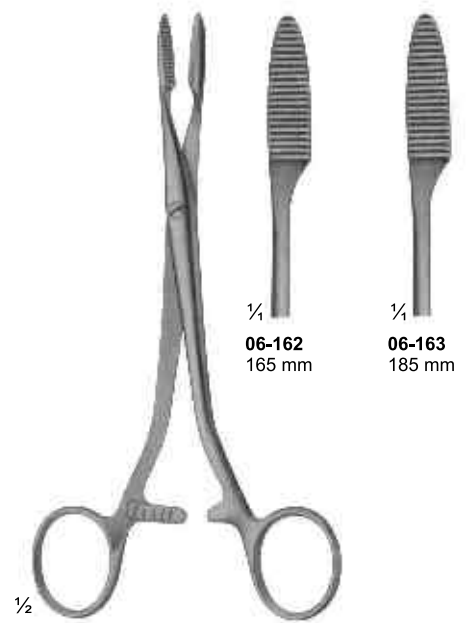

**06-162 - 163**  
PEAN

**06-162**  
165 mm

**06-163**  
185 mm

# Haemostatic Forceps



**06-164 - 167**  
PEAN  
Slender type

**06-168 - 175**  
SPENCER-WELLS  
Slender type

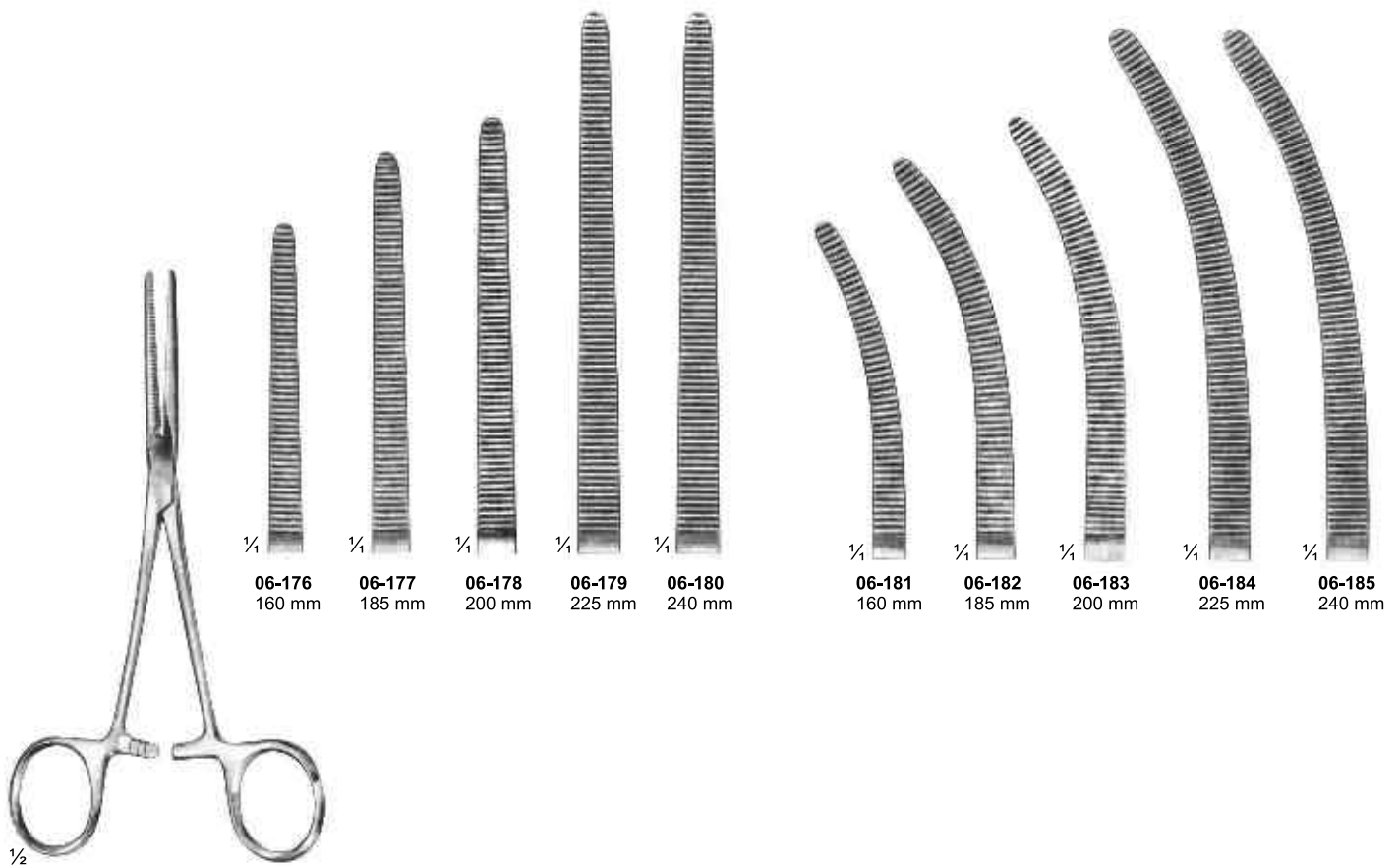

**06-176 - 185**  
ROCHESTER-PEAN

# Haemostatic Forceps



**06-186 - 191**  
PEAN

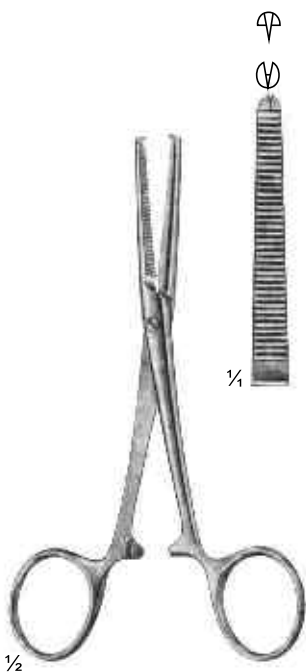
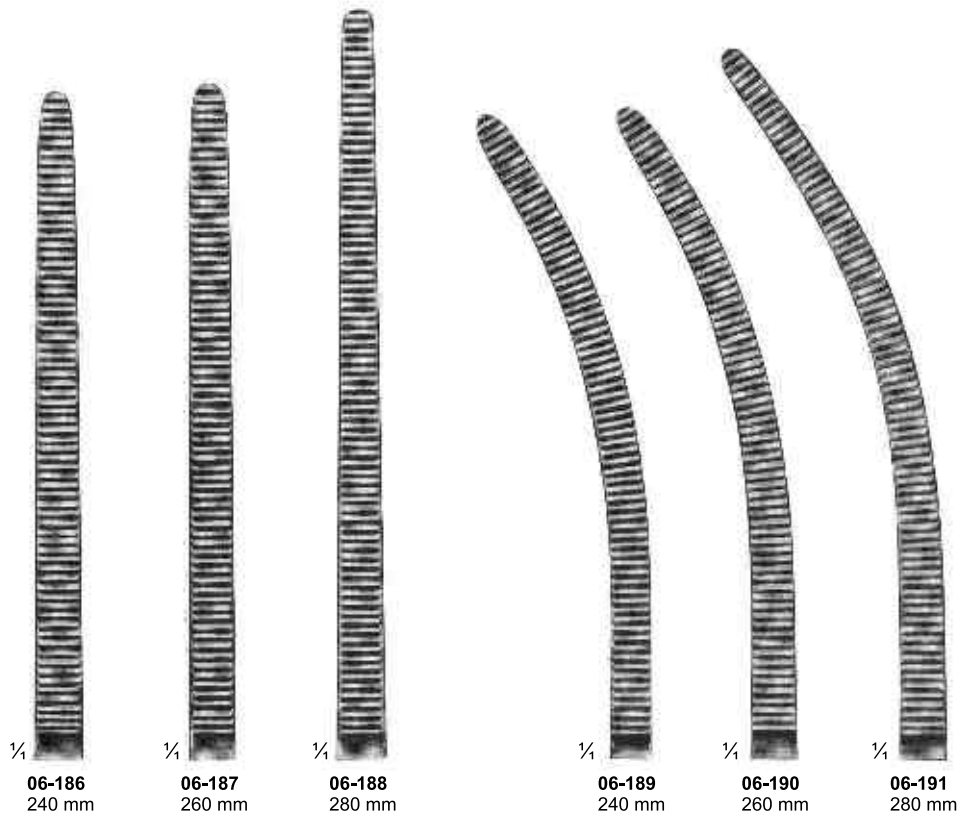

**06-192**  
KOCHER  
Strong Pattern  
145 mm

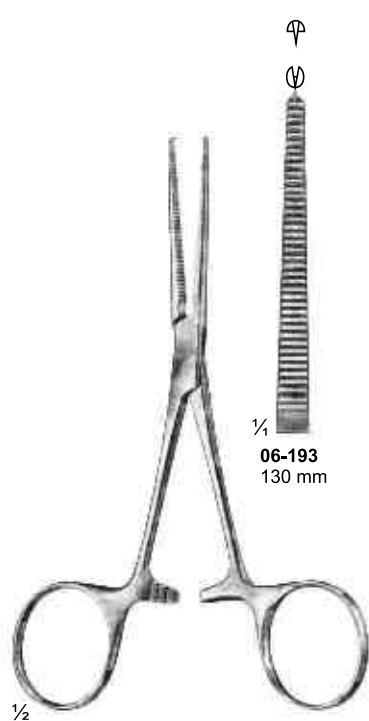

**06-193 - 195**  
KOCHER

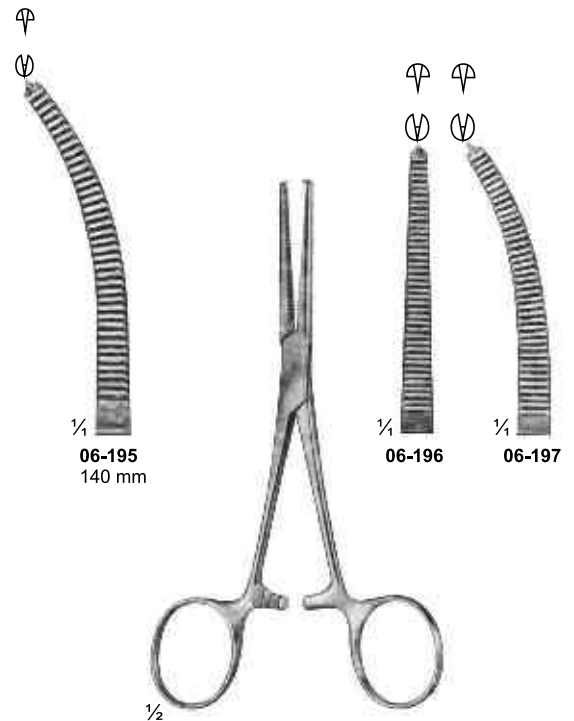

**06-196 - 197**  
ROCHESTER-OGHSNER  
140 mm

# Haemostatic Forceps

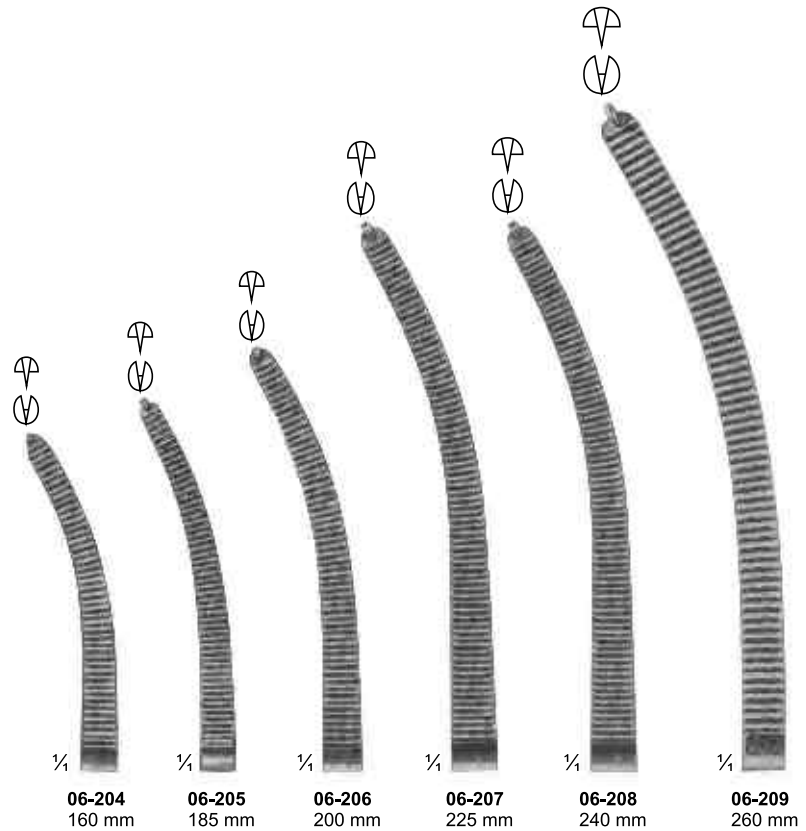
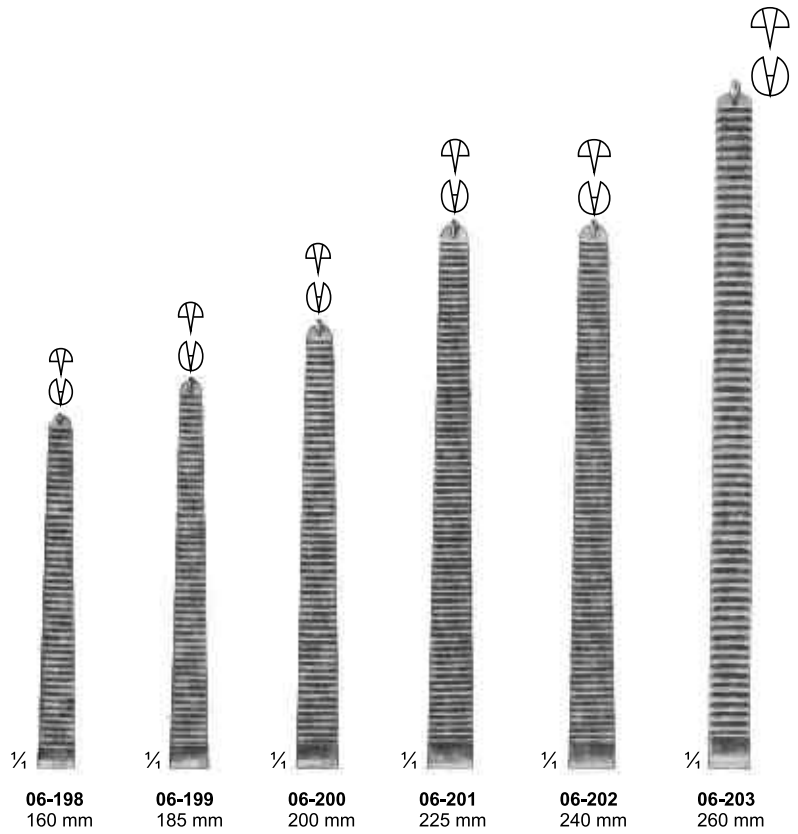

06-198 - 209  
KOCHER-OCHSNER

# Haemostatic Forceps, Special Pattern, Tonsil Forceps

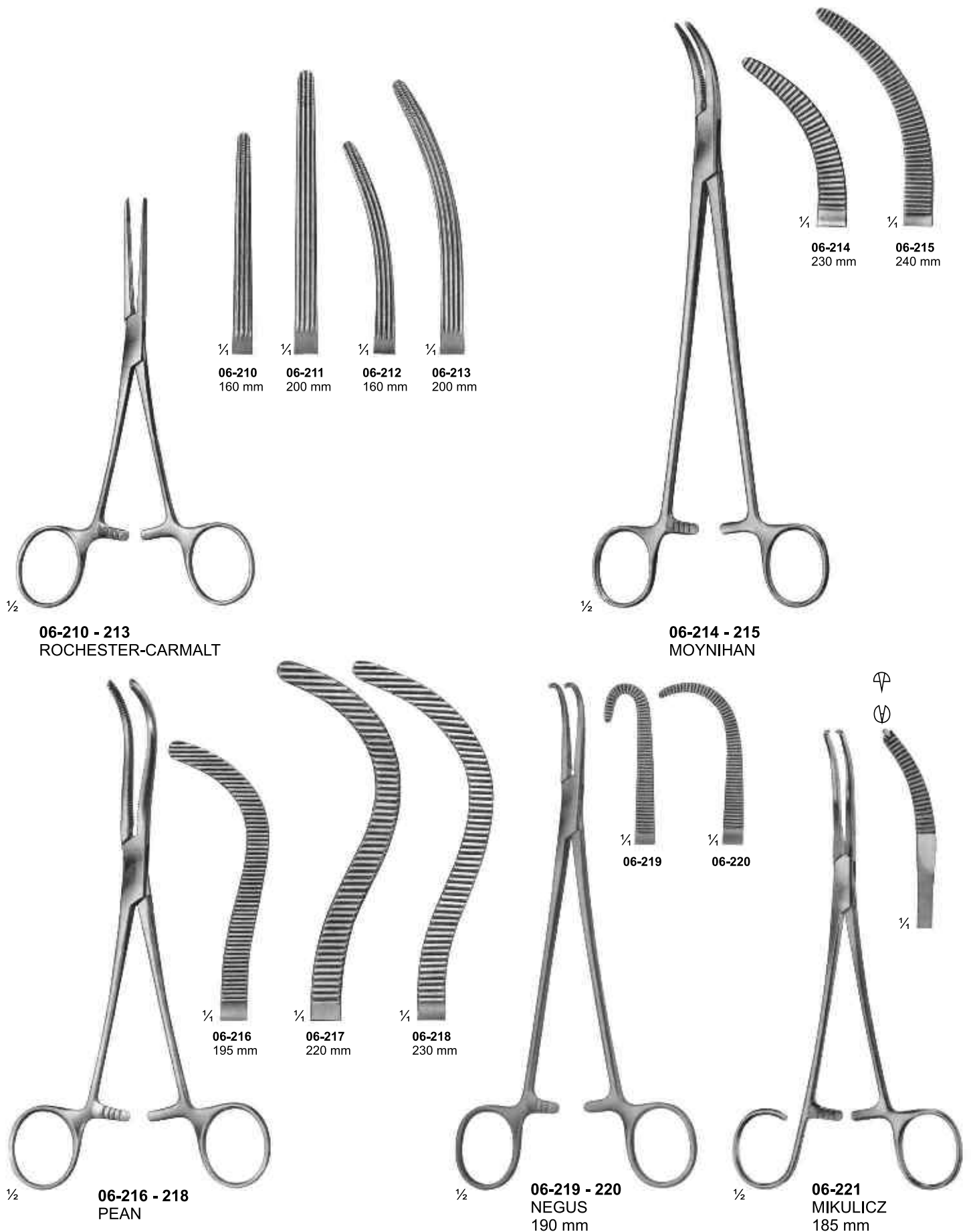

# Dissecting- and Ligature Forceps



**06-222**  
MICRO-ADSON  
140 mm



**06-223**  
BABY-OVERHOLT  
135 mm



**06-224 - 225**  
BABY-MIXTER

**06-224**  
140 mm

**06-225**  
180 mm



**06-226 - 227**  
BABY-ADSON

**06-226**  
140 mm

**06-227**  
180 mm



**06-228**  
NISSEN

**06-228**  
185 mm



**06-229 - 230**  
YASARGIL  
195 mm

**06-229**

**06-230**

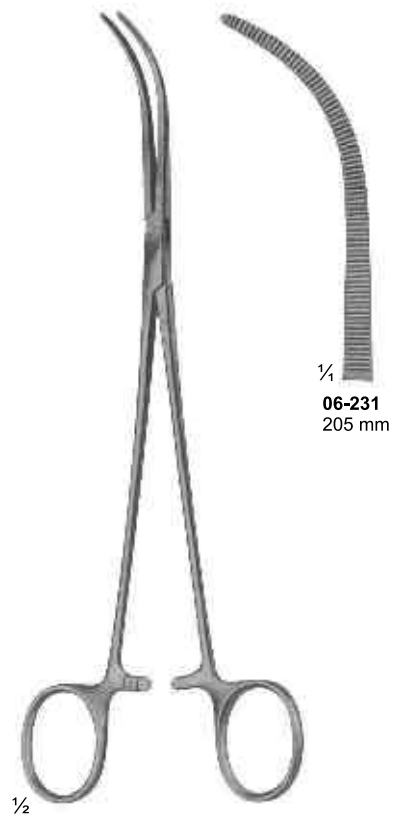

**06-231**  
OVERHOLT-MIXTER

**06-231**  
205 mm



# Dissecting- and Ligature Forceps

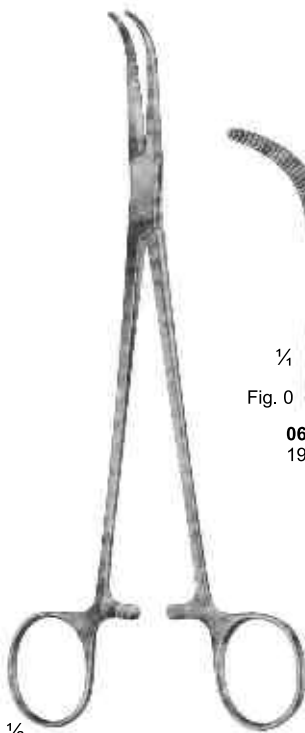

1/2

**06-232 - 243**  
OVERHOLT-GEISSENDOERFER

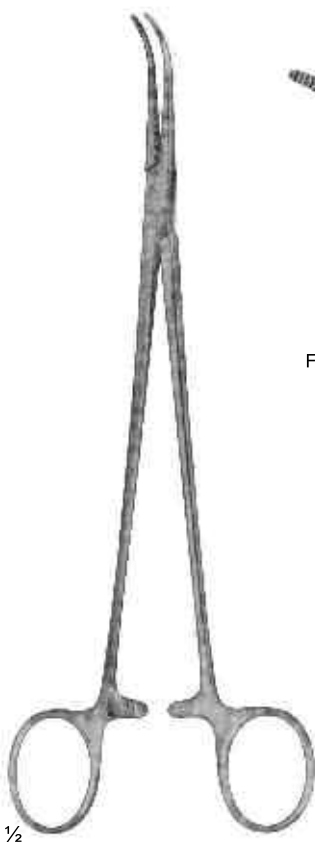
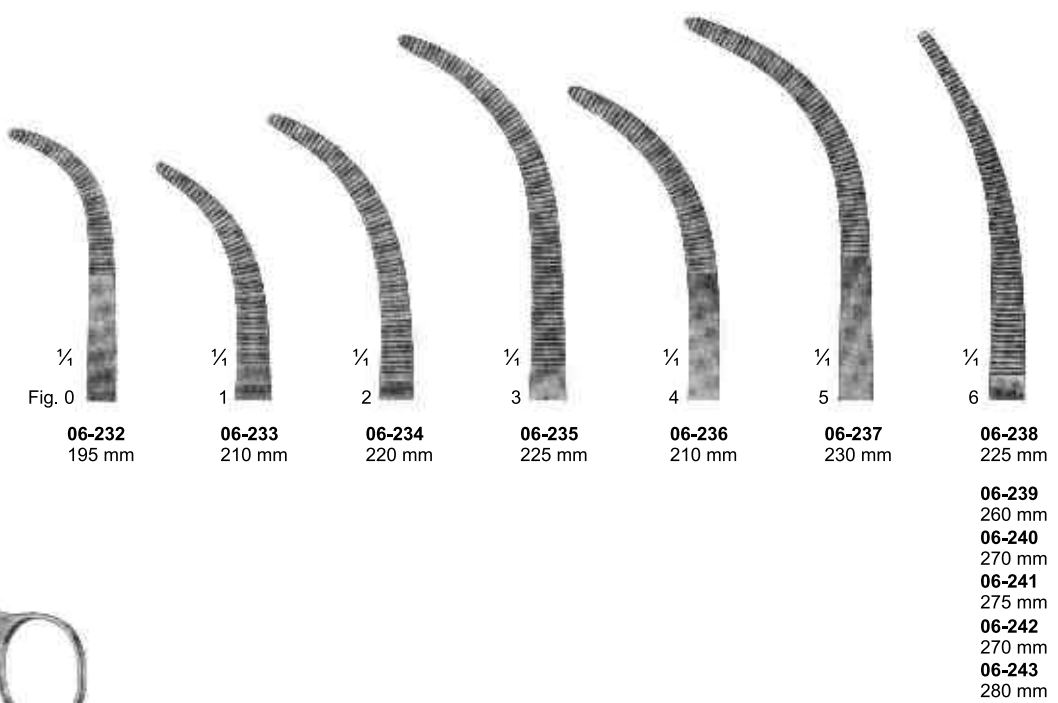

1/2

**06-244 - 251**  
OVERHOLT  
fine pattern

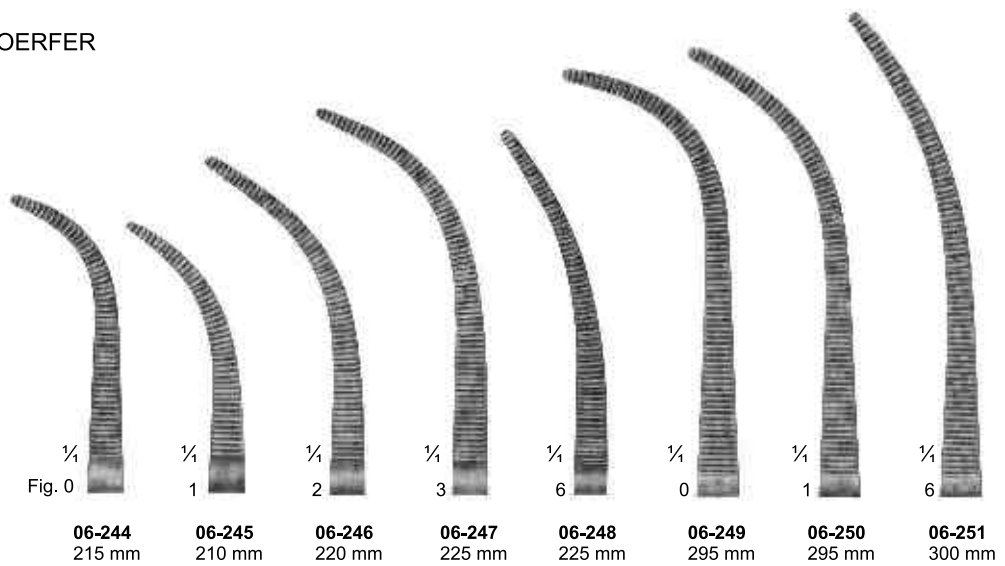

# Dissecting- and Ligature Forceps



$\frac{1}{2}$   
**06-252**  
 MIXTER-O'SHAUGHNESSY  
 190 mm

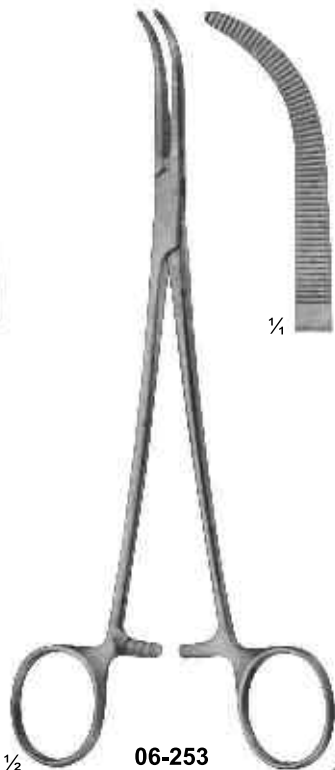

$\frac{1}{2}$   
**06-253**  
 HEISS  
 195 mm

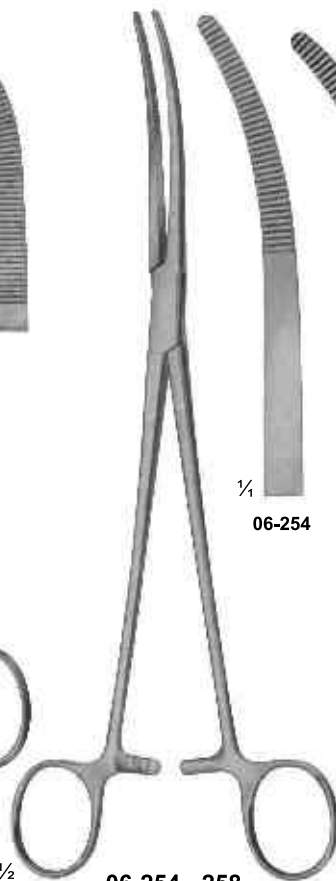

$\frac{1}{2}$   
**06-254 - 258**  
 RUMEL  
 240 mm

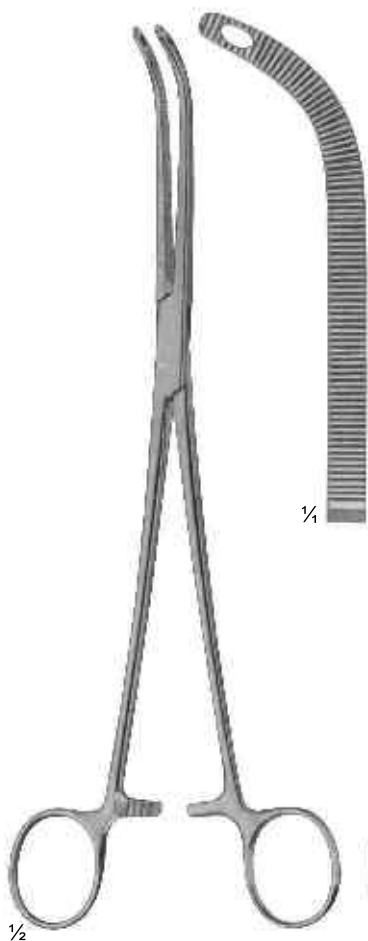
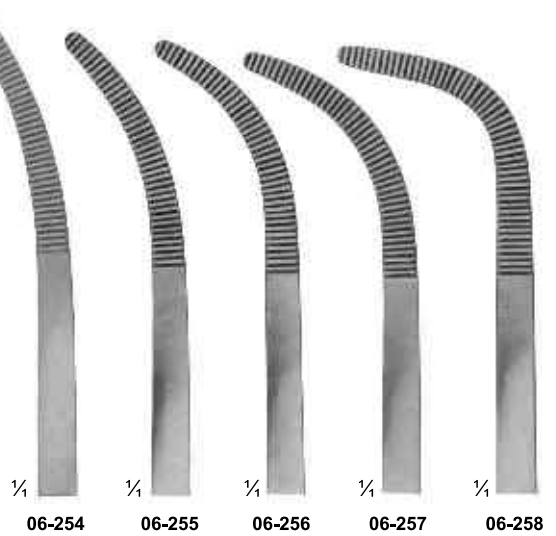

$\frac{1}{2}$   
**06-259**  
 FINOCHIETTO  
 245 mm



$\frac{1}{2}$   
**06-260**  
 MIXTER  
 230 mm



$\frac{1}{3}$   
**06-261**  
 LAWRENCE  
 270 mm

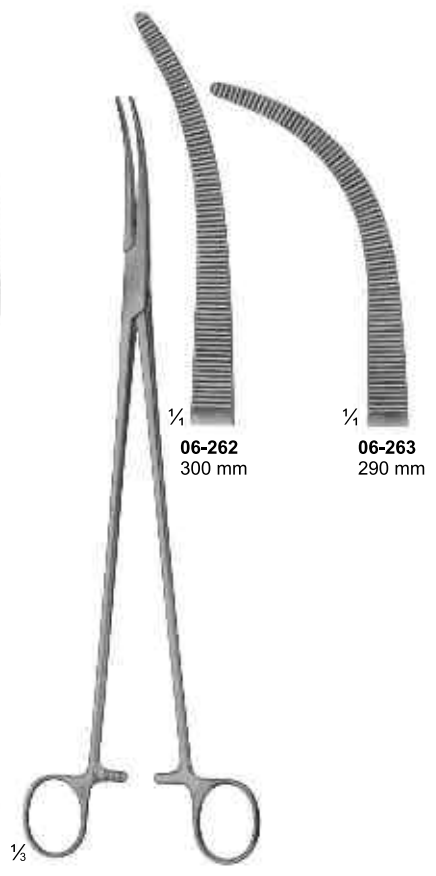

$\frac{1}{3}$   
**06-262 - 263**  
 ZENKER

# Dissecting- and Ligature Forceps

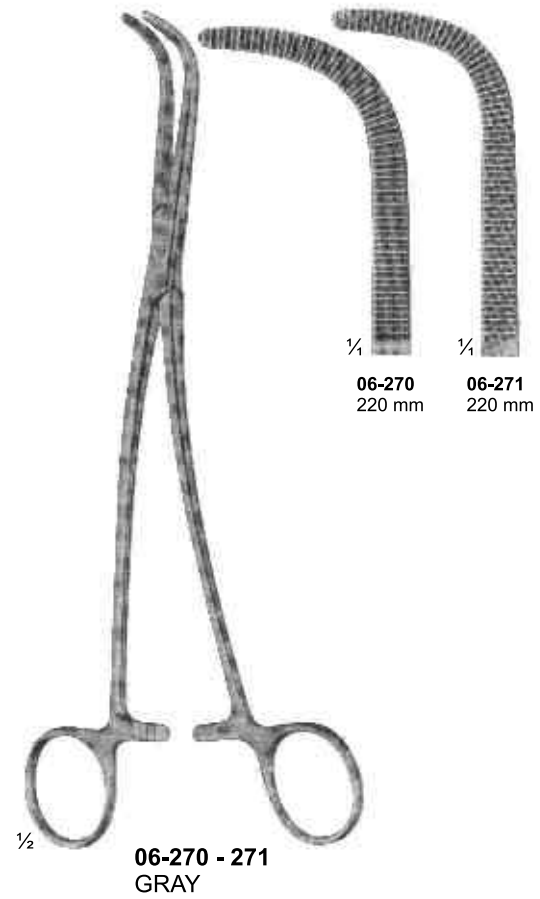
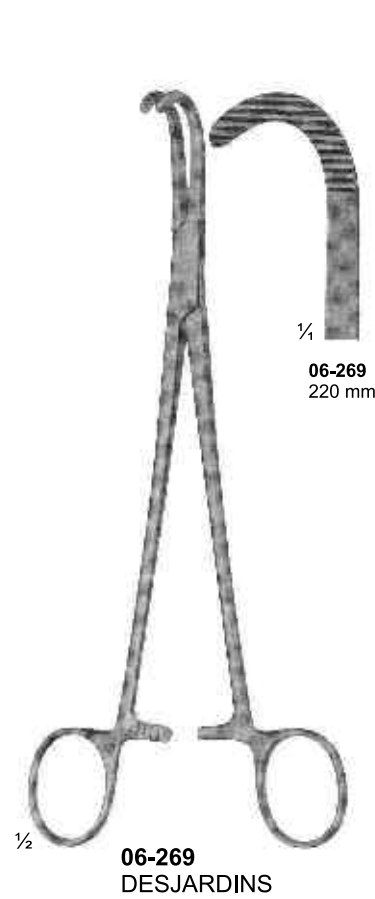
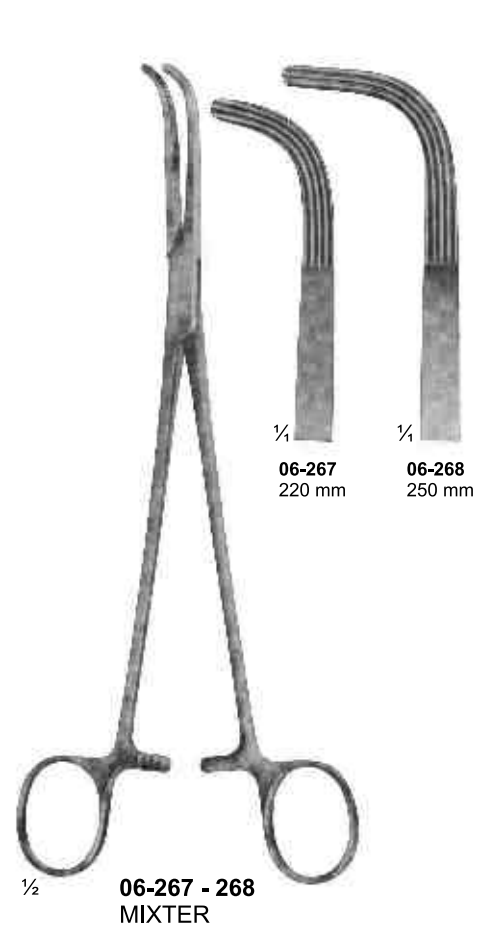
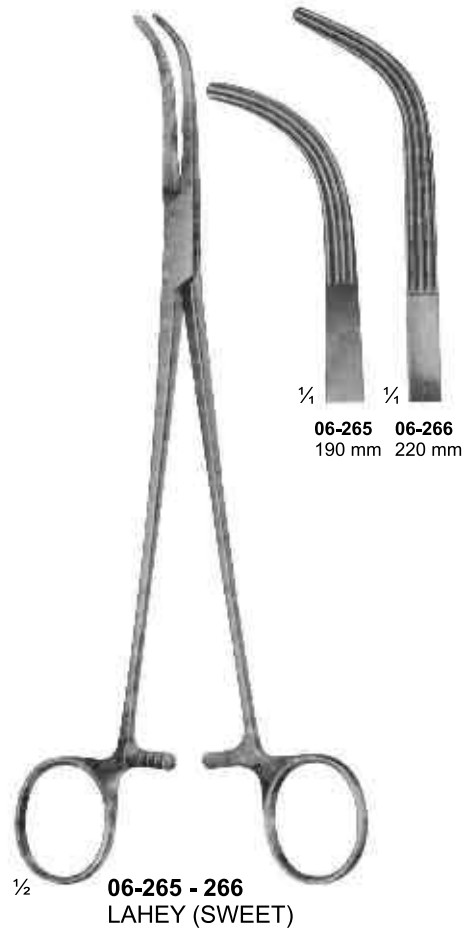
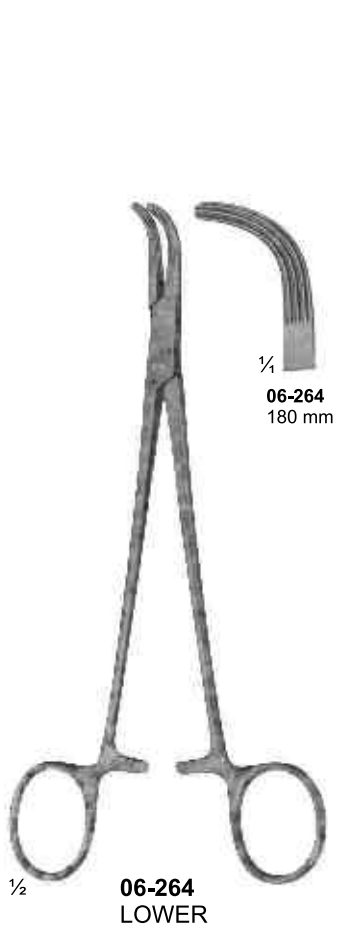

# Peritoneum Forceps

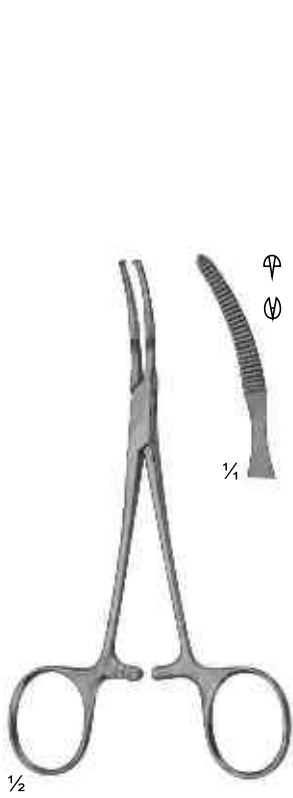

**06-272**  
BABY-MIKULICZ  
140 mm

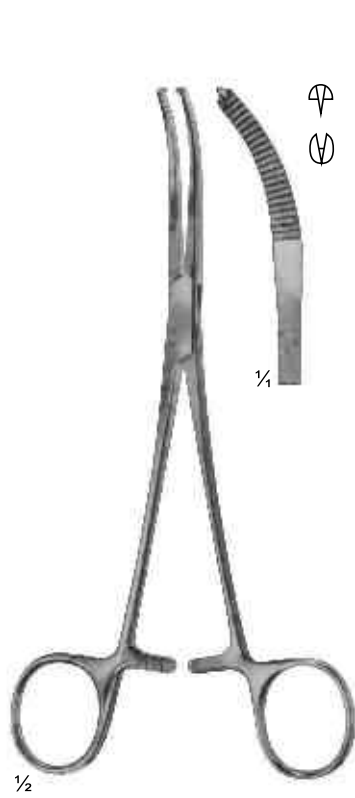

**06-273**  
MIKULICZ  
185 mm

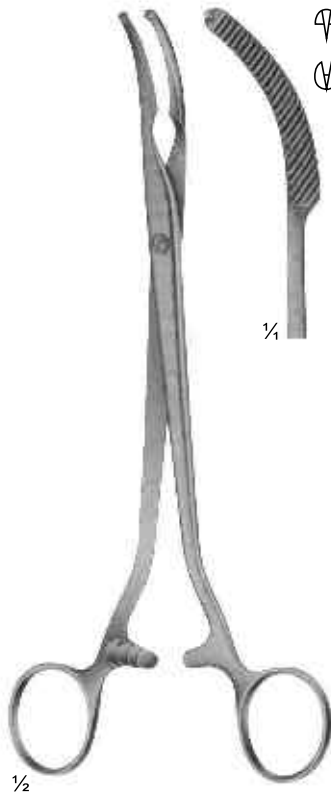

**06-274**  
MIKULICZ  
205 mm

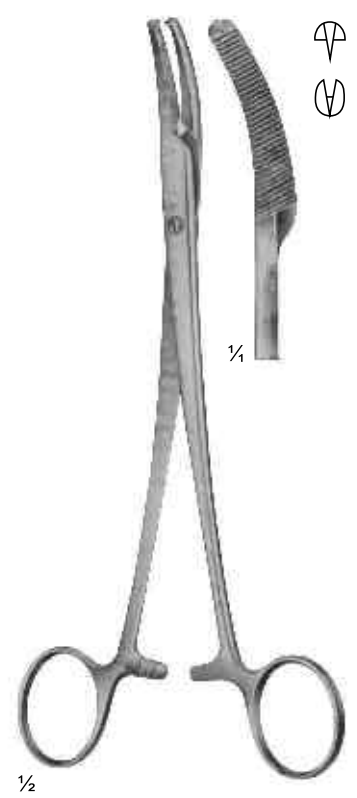

**06-275**  
MIKULICZ  
200 mm

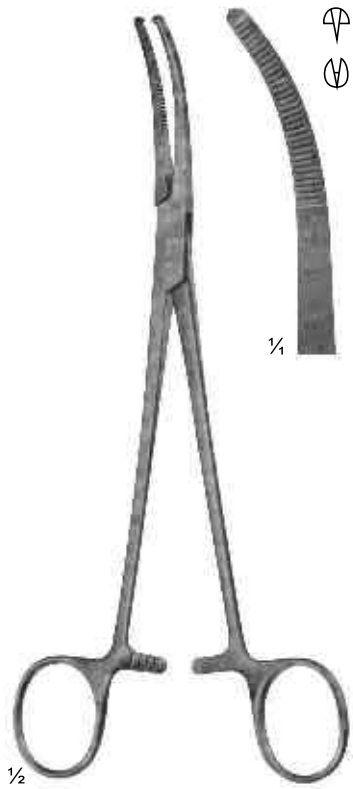

**06-276**  
MIKULICZ  
205 mm

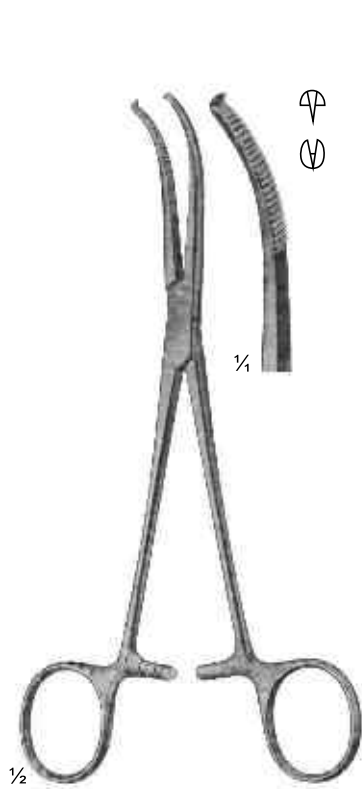

**06-277**  
MIKULICZ  
185 mm

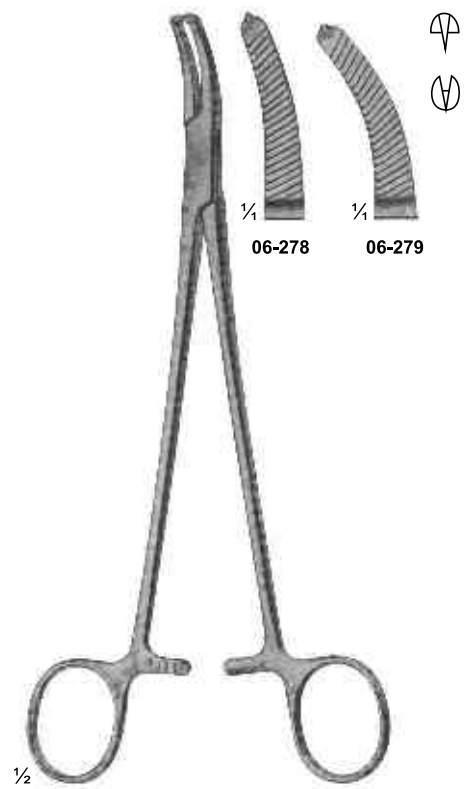

**06-278 - 279**  
FAURE  
205 mm

# Hysterectomy Forceps

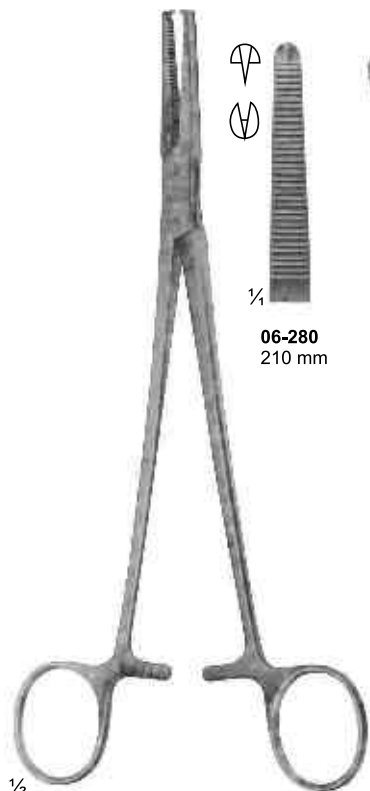

**06-280 - 281**  
PHANEUF

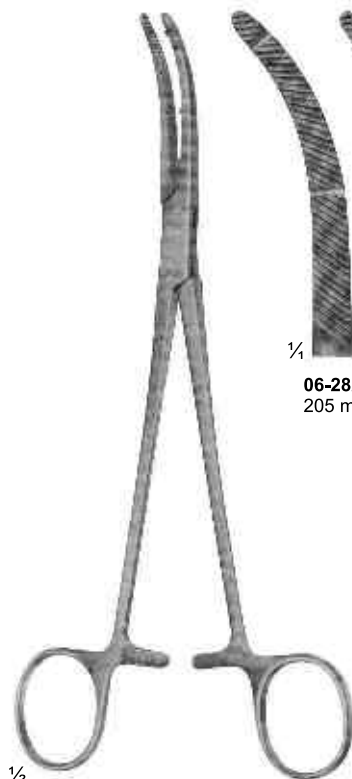

**06-282 - 283**  
HEANEY modif.

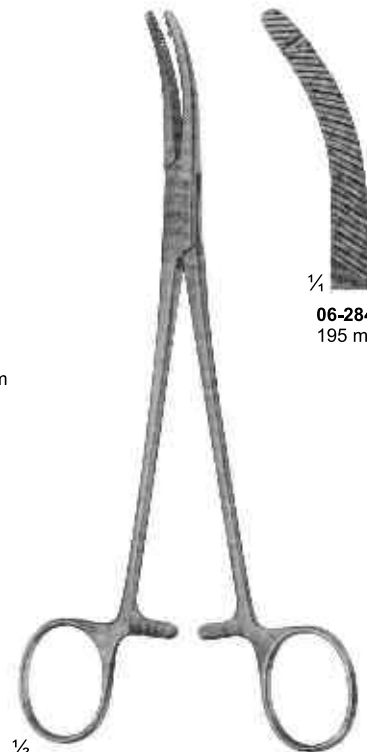

**06-284**  
HEANEY

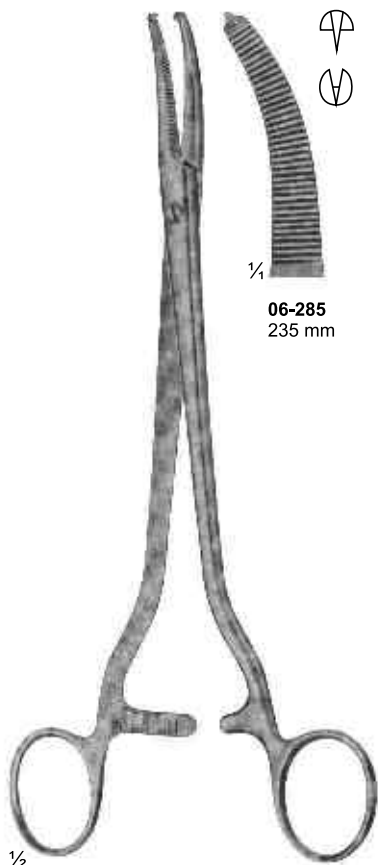

**06-285**  
WERTHEIM

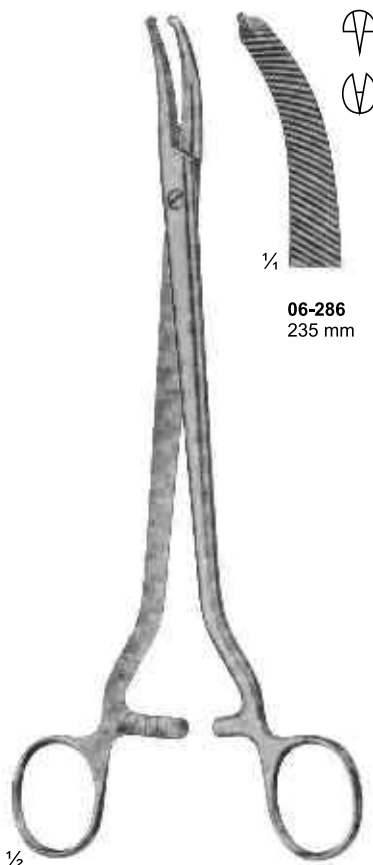

**06-286**  
WERTHEIM

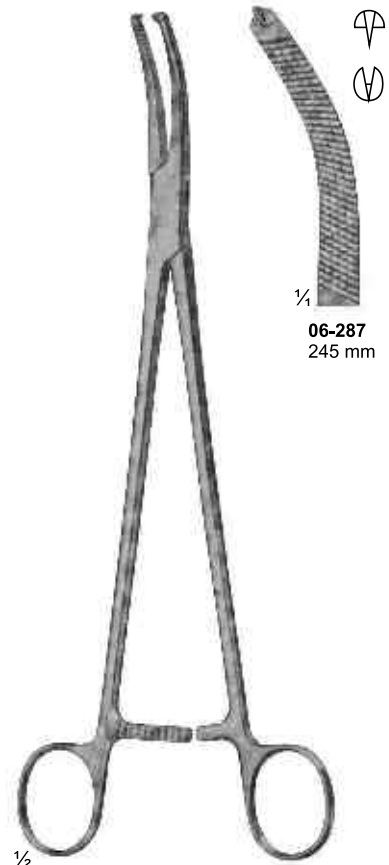

**06-287**  
WERTHEIM

# Hysterectomy Forceps and Vaginal Clamps

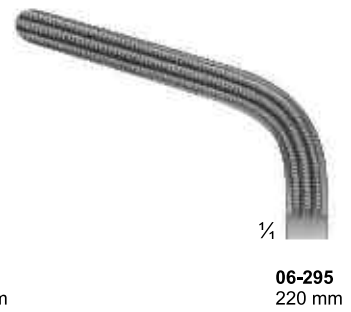
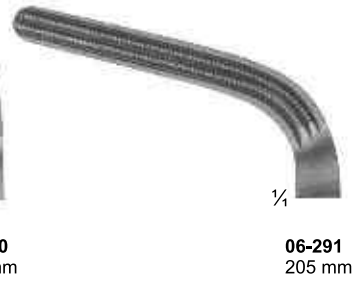

# Hysterectomy Forceps and Vaginal Clamps and Compression Forceps

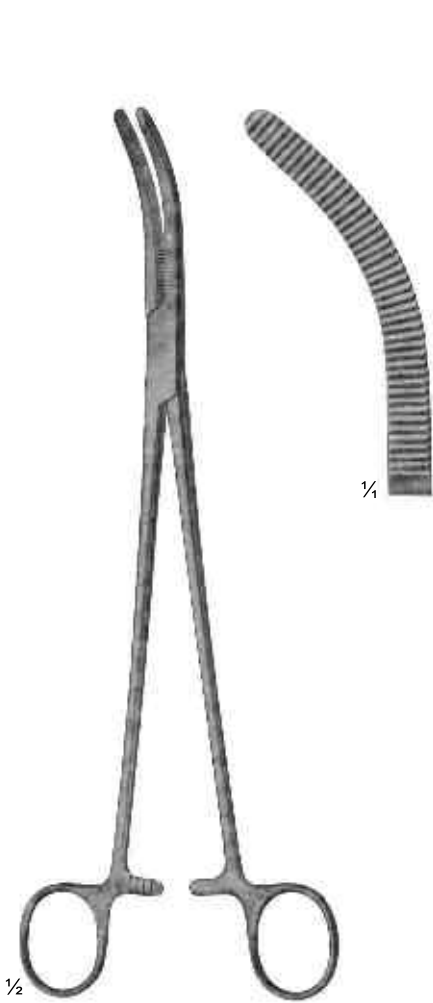

$\frac{1}{2}$   
**06-296**  
**WERTHEIM**  
 Hysterectomy Forceps  
 255 mm

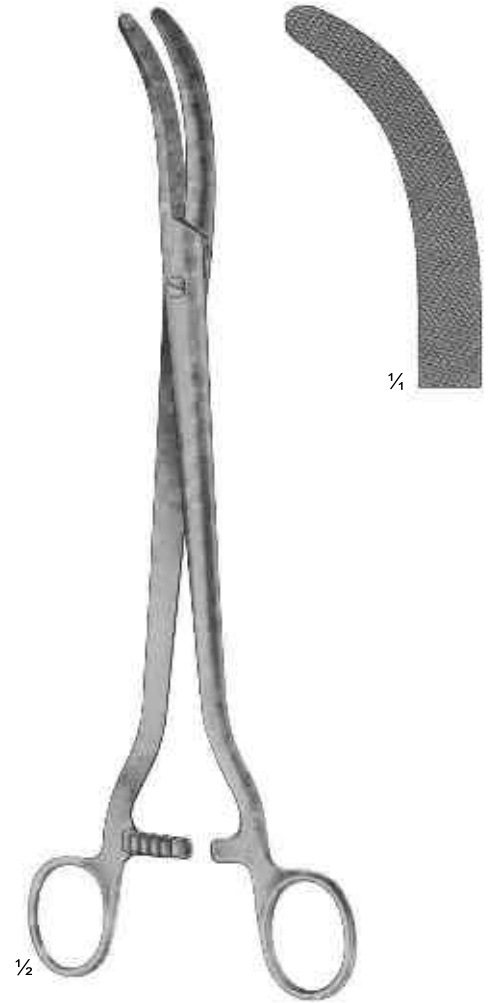

$\frac{1}{2}$   
**06-297**  
**WERTHEIM**  
 Parametrium Clamp  
 260 mm

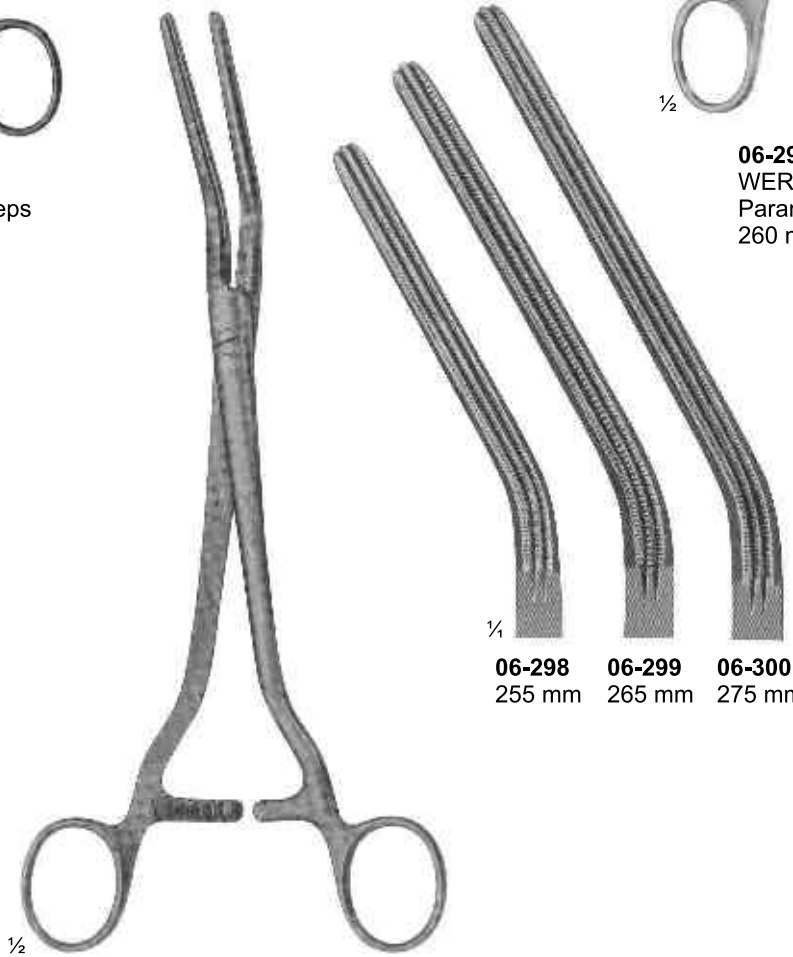

$\frac{1}{2}$   
**06-298 - 300**  
**DICK**

$\frac{1}{4}$   
**06-298** 255 mm  
**06-299** 265 mm  
**06-300** 275 mm

# Hysterectomy Forceps and Vaginal Clamps and Compression Forceps

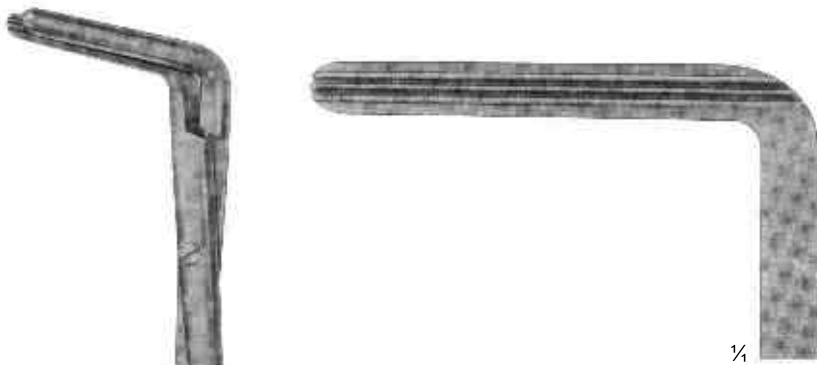

**06-301**  
WERTHEIM  
250 mm

1/2

1/4

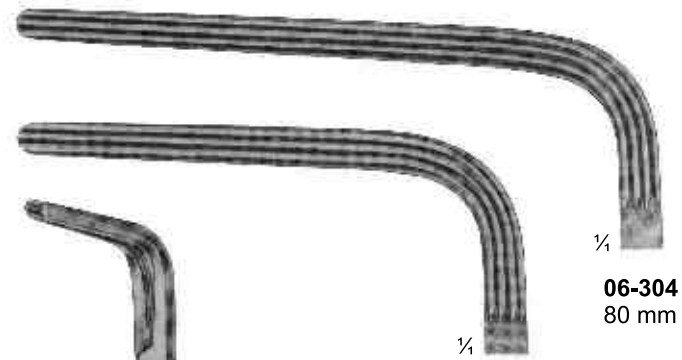

1/4

**06-304**  
80 mm

1/4

**06-303**  
60 mm



1/2

**06-303 - 304**  
230 mm



1/2

**06-302**  
WERTHEIM-CULLEN  
215 mm



# Needle Holders For Micro Surgery



**07-101**  
ROHRSCHEIDER  
With copper inserts  
100 mm



**07-102**  
KALT  
With catch  
135 mm



**07-103**  
ARRUGA  
With catch  
135 mm



**07-104 - 105**  
CASTROVIEJO  
With catch  
145 mm



**07-106 - 107**  
CASTROVIEJO  
With Catch  
160 mm



**07-108 - 109**  
Without catch  
185 mm



**07-110 - 111**  
JACOBSON  
185 mm



**07-112**  
Without catch  
195 mm



**07-113 - 114**  
YASARGIL  
With catch  
200 mm

# Micro Needle Holders With Round Handles

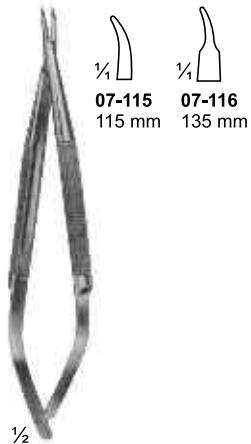

**07-115**  
115 mm

**07-116**  
135 mm

**07-115 116**  
BARRAQUER  
Without catch



**07-117**

**07-118**

**07-117 - 118**  
BARRAQUER  
Without catch  
120 mm



**07-119**

**07-120**

**07-119 - 120**  
BARRAQUER  
With catch  
120 mm



**07-121**

**07-122**

**07-121 - 122**  
BARRAQUER  
With Catch  
150 mm



**07-123**  
MULLER  
With Locking  
Mechanism  
145 mm



**07-124**

**07-125**

**07-124 - 125**  
BROCK  
Without catch  
150 mm



**07-126**

**07-127**

**07-126 - 127**  
YASARGIL  
200 mm



**07-128**

**07-129**

**07-128 - 129**  
YASARGIL  
225 mm



**07-130**  
YASARGIL  
245 mm

# Needle Holders

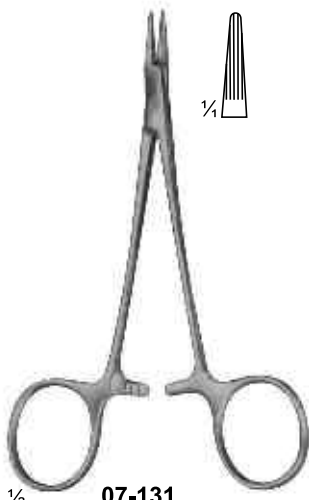

1/2 **07-131**  
CONVERSE  
125 mm



1/2 **07-132**  
WEBSTER  
125 mm

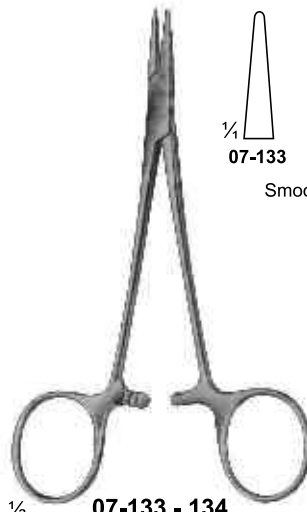

1/2 **07-133 - 134**  
HALSEY  
130 mm



1/2 **07-135**  
DERF  
130 mm



1/2 **07-136**  
DOYEN  
125 mm



1/2 **07-137**  
BAUMGARTNER  
145 mm

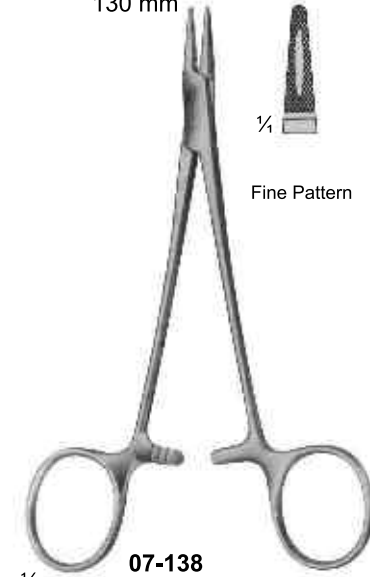

1/2 **07-138**  
CRILE-WOOD  
150 mm



1/2 **07-139**  
CRILE-WOOD  
160 mm

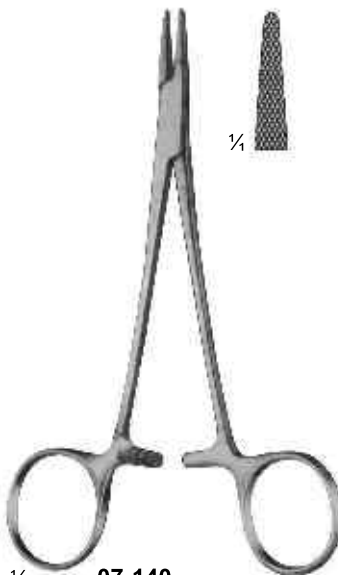

1/2 **07-140**  
CRILE-MURRAY  
150 mm

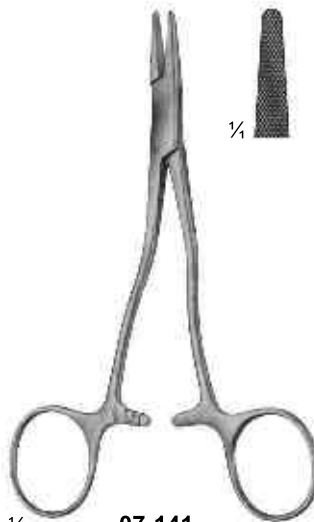

1/2 **07-141**  
KILNER  
135 mm



1/2 **07-142**  
ADSON  
175 mm

# Needle Holders

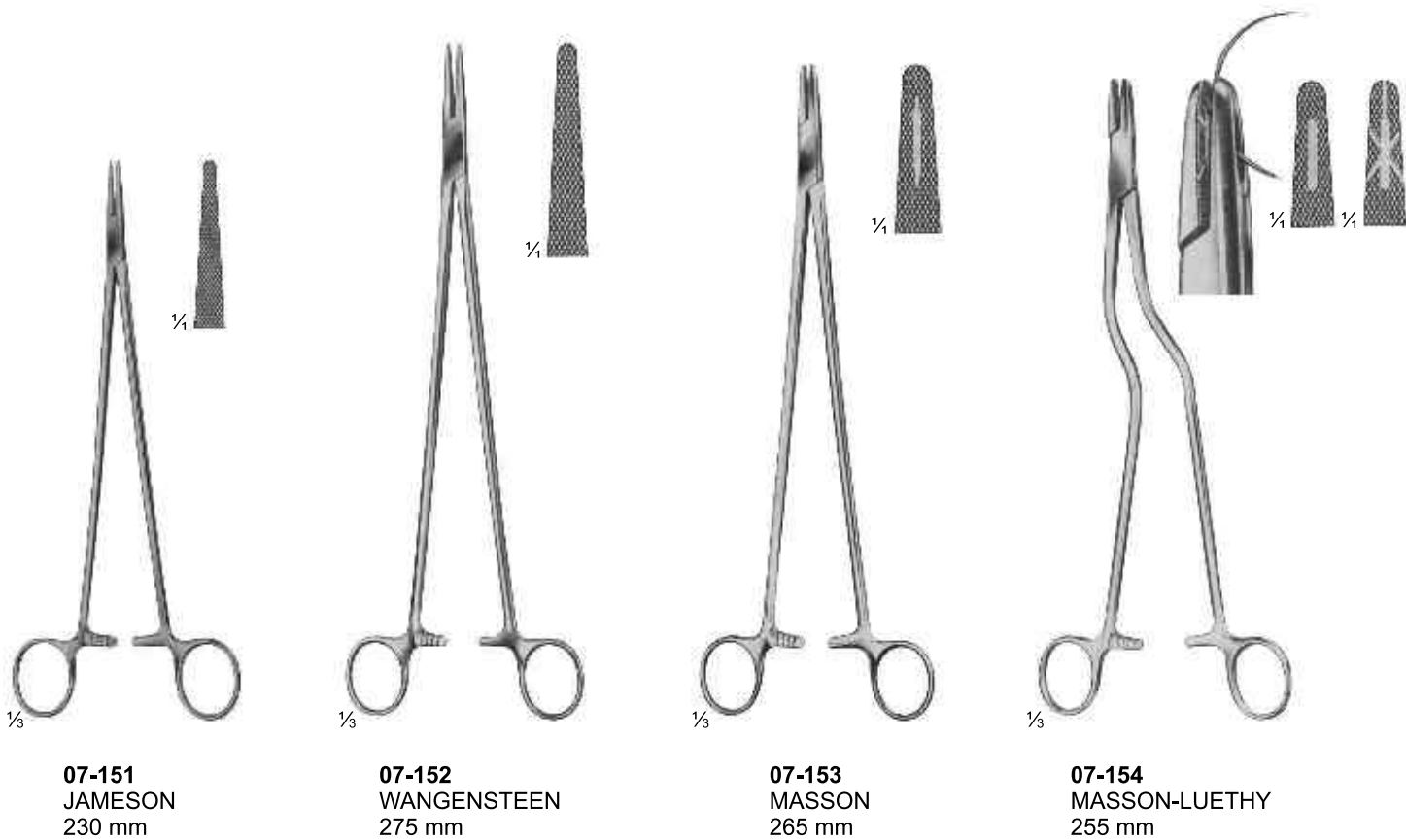



# Needle Holders

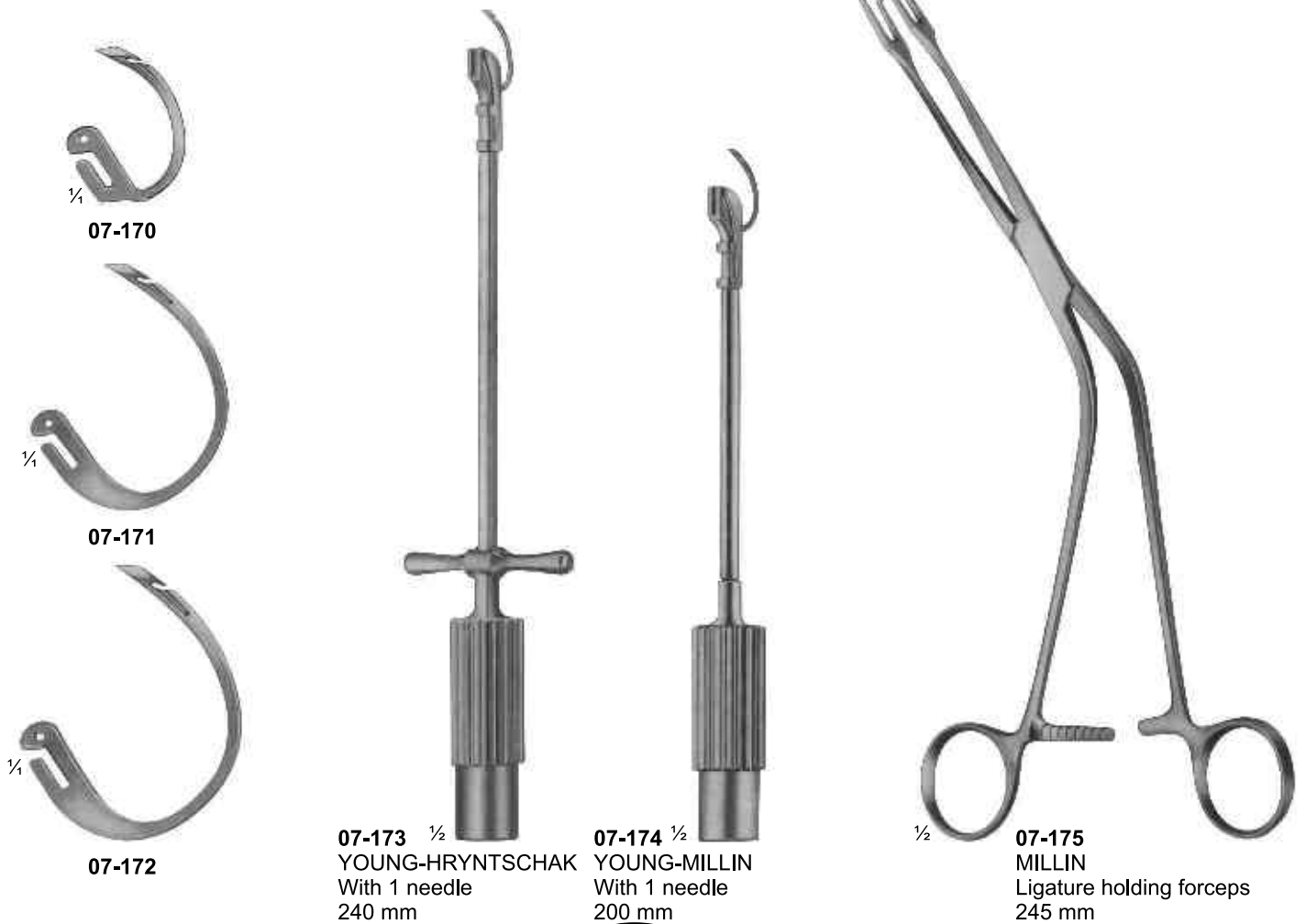
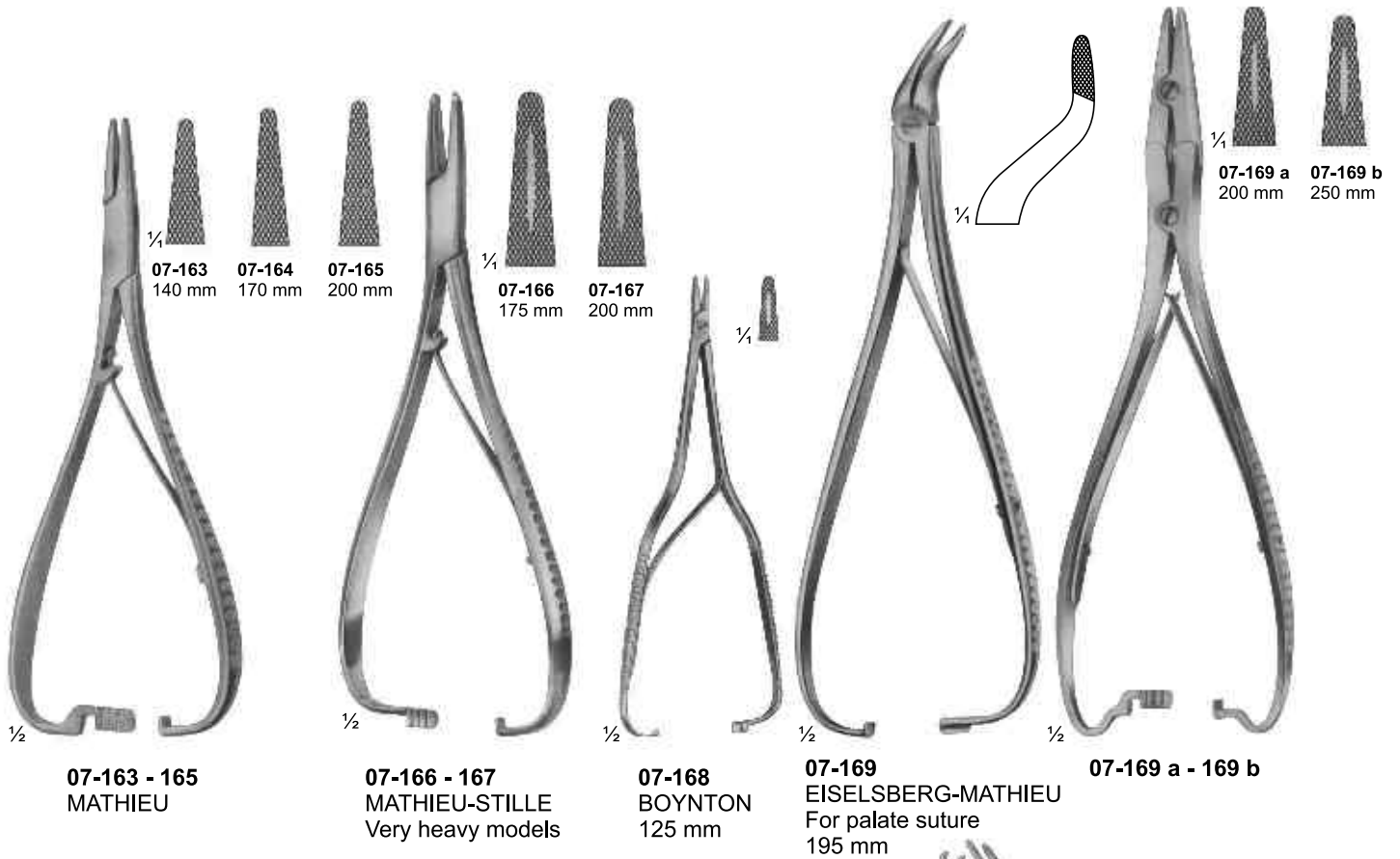

# Suture Instruments - Reverdin Needles

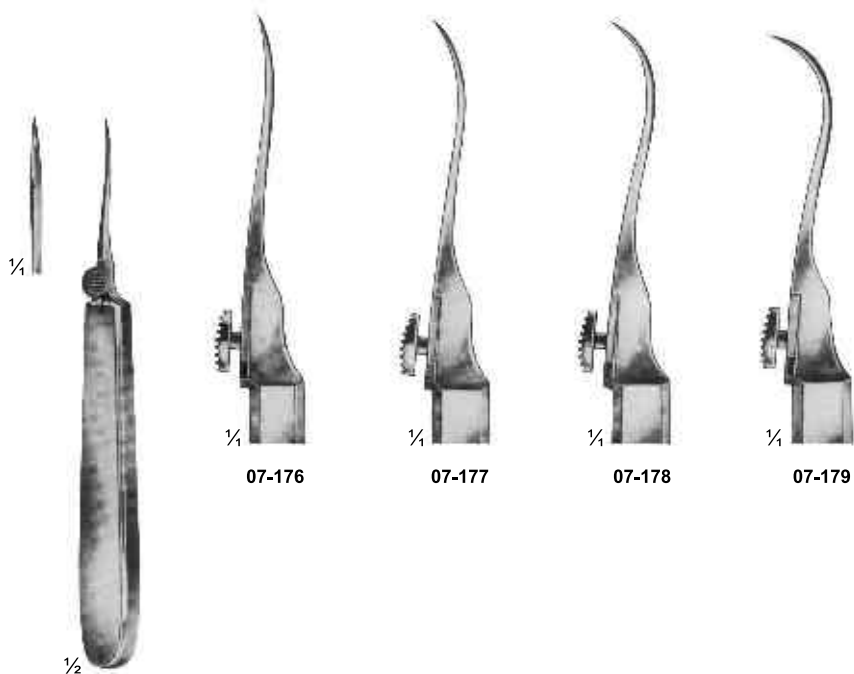

**07-176 - 179**  
REVERDIN  
140 mm

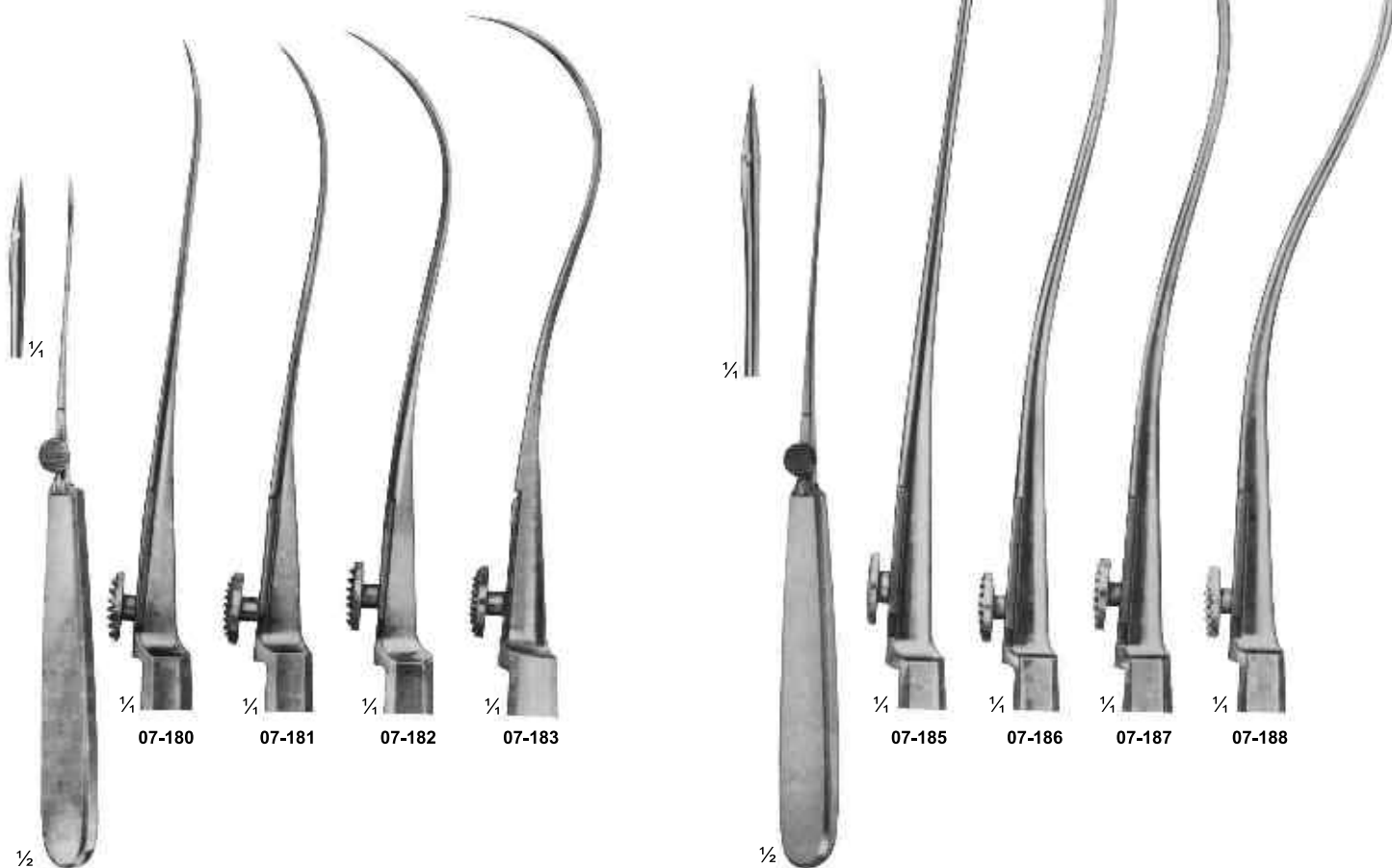

**07-180 - 183**  
REVERDIN  
195 mm

**07-184 - 188**  
REVERDIN  
220 mm

# Suture Instruments - Ligature Needles

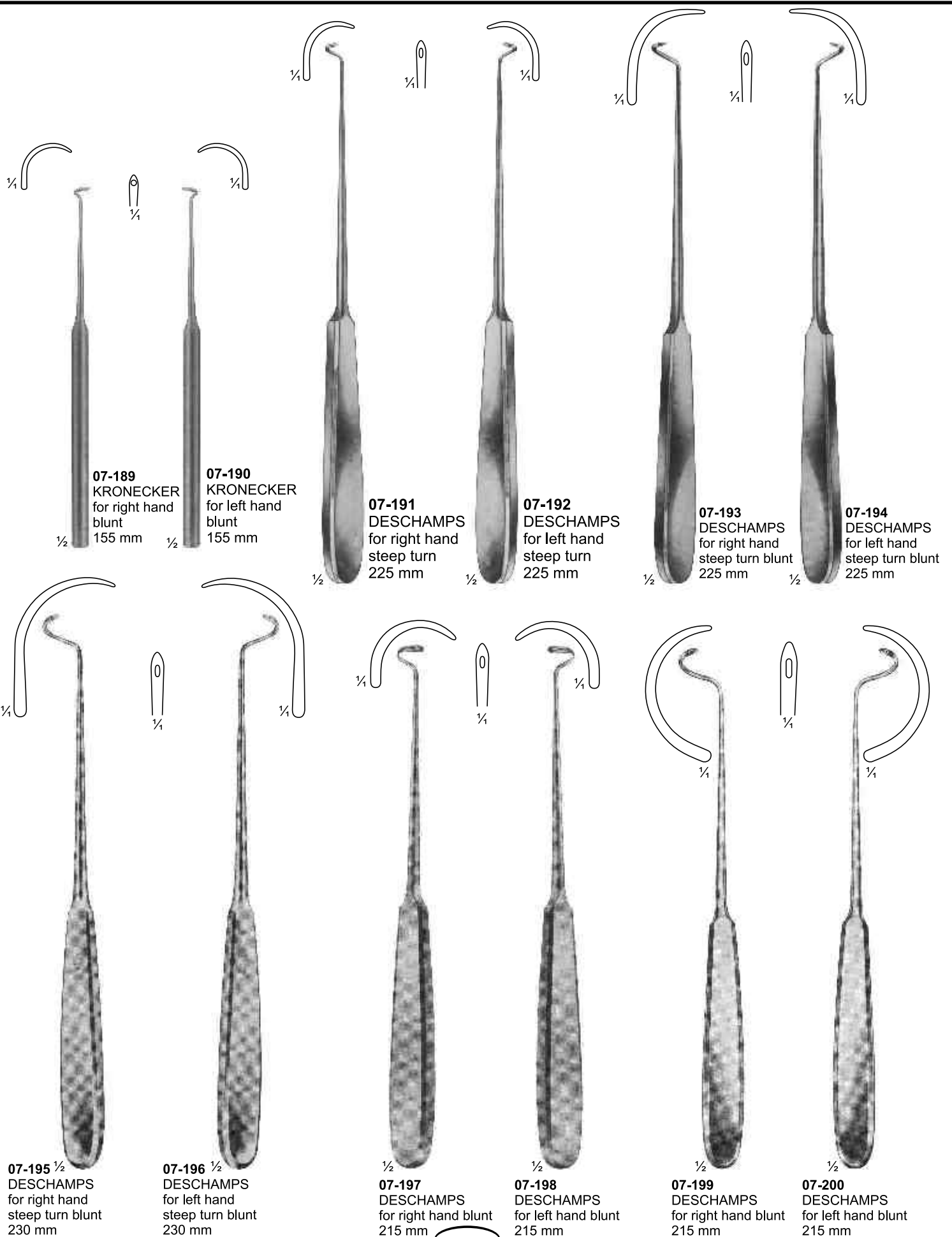



# Suture Instruments - Ligature Needles



**07-201**  
HURD  
for right hand  
sharp  
210 mm



**07-202**  
HURD  
for left hand  
sharp  
210 mm



**07-203**  
DESCHAMPS  
for right hand  
sharp  
215 mm



**07-204**  
DESCHAMPS  
for left hand  
sharp  
215 mm



**07-205**  
JONESCO  
Needle for wire suture  
185 mm



**07-206**  
CLAUS VAN EICKEN  
Needle for wire suture  
250 mm

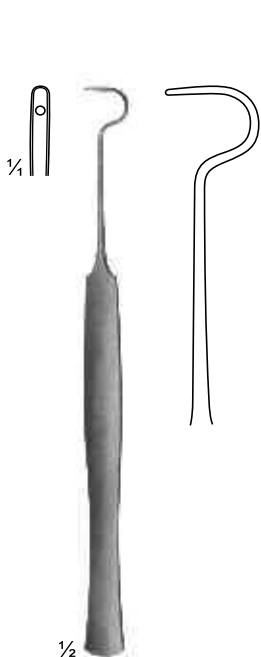

**07-207**  
150 mm

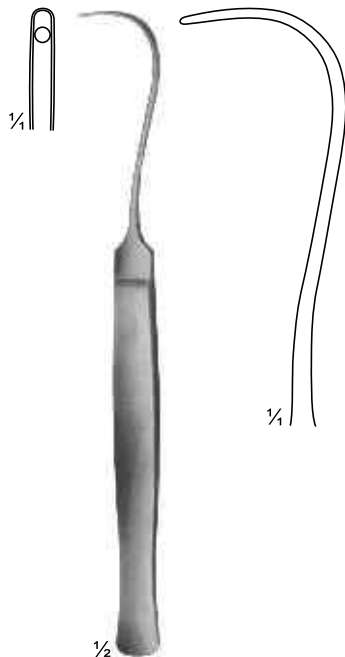

**07-208**  
SYME  
170 mm

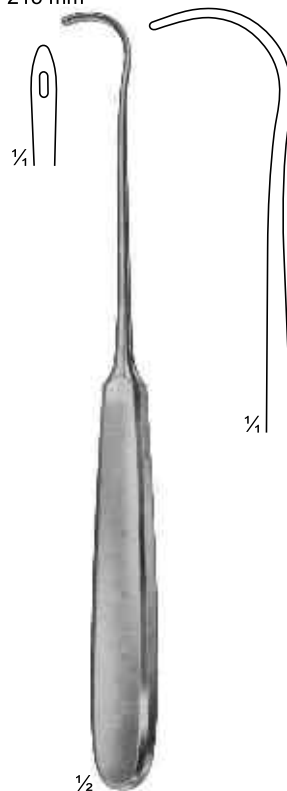

**07-209**  
COOPER  
205 mm

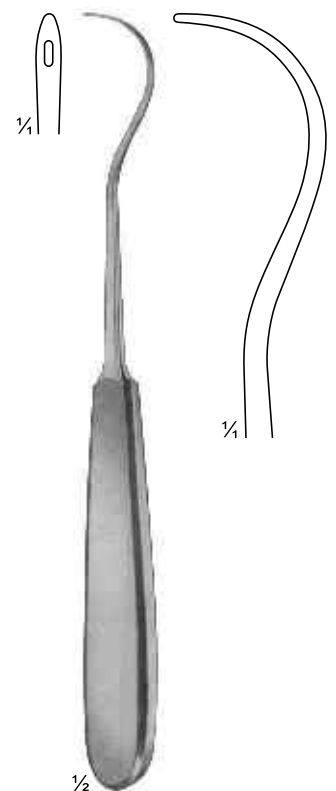

**07-210**  
KOCHER  
205 mm

# Ligature Needles

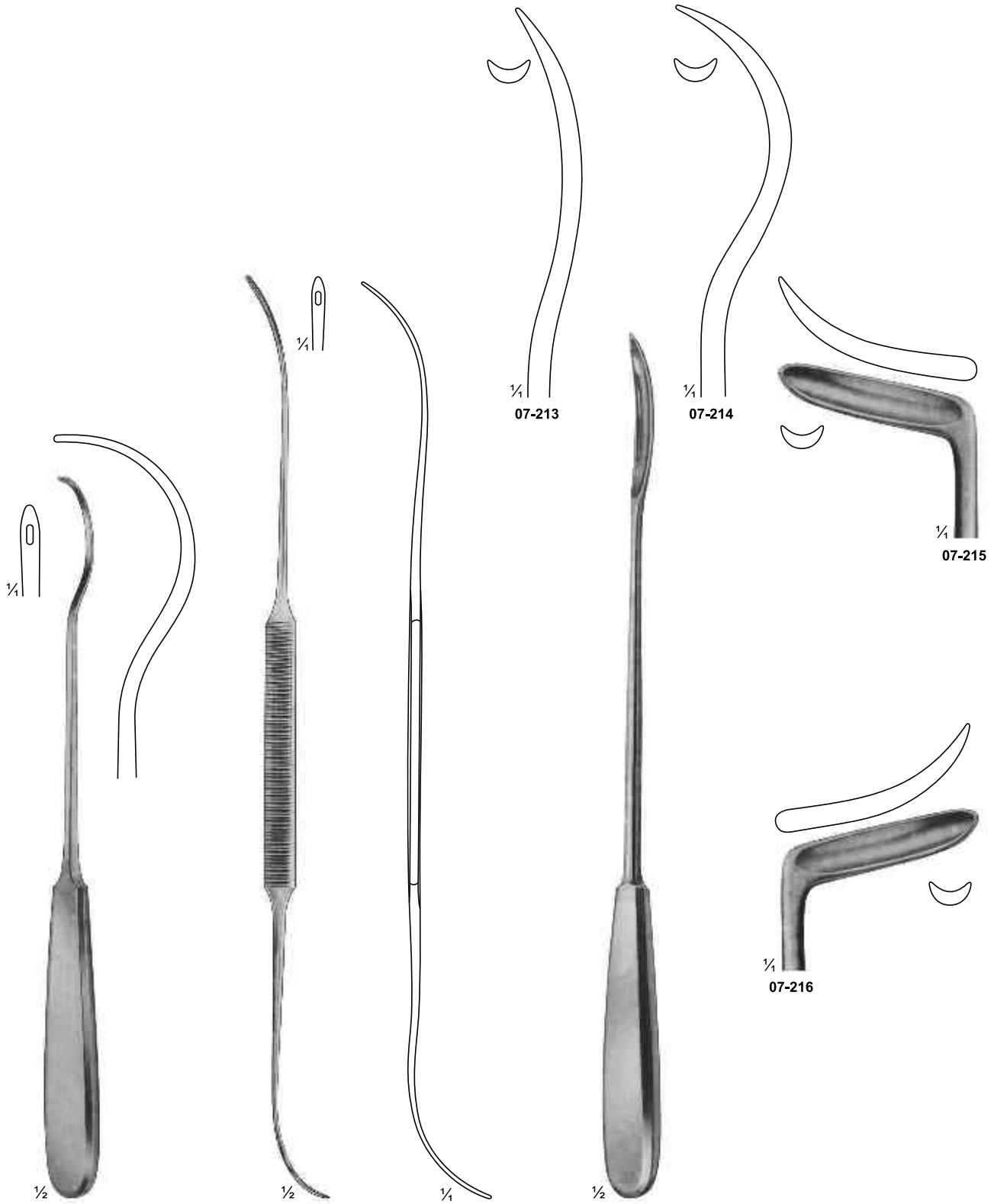

**07-211**  
BRUNNER  
240 mm

**07-212**  
SCHMIEDEN-DICK  
320 mm

**07-213 - 216**  
BRUNNER  
Guiding Probes  
300 mm



# Probes

07-242  
2,5 mm  
07-243  
2,5 mm  
07-244  
3,0 mm



07-242 145 mm  
07-243 160 mm  
07-244 200 mm  
Probes with eye

1,5 mm



07-245  
Myrtle leaf probe  
145 mm

2,0 mm



07-246 130 mm  
07-247 145 mm  
07-248 160 mm  
07-249 180 mm  
07-250 200 mm



07-251  
Probes



07-252  
Double ended probe,  
malleable, diam. of tips  
3 mm with hole  
190 mm



07-253  
Double ended probes,  
tin, malleable,  
diam. of tips  
3,5 mm with hole  
250 mm, 300 mm



07-254  
Double ended probes,  
tin, malleable,  
diam. of tips 4 mm  
400 mm



07-255 1,5 mm  
07-256 2,0 mm  
07-257 2,5 mm  
300 mm

# Probes



**07-242** 2,5 mm  
**07-243** 2,5 mm  
**07-244** 3,0 mm

1/2

**07-242** 145 mm  
**07-243** 160 mm  
**07-244** 200 mm  
 Probes with eye



1,5 mm

1/2

**07-245**  
 Myrtle leaf probe  
 145 mm



2,0 mm

1/2

**07-246** 130 mm  
**07-247** 145 mm  
**07-248** 160 mm  
**07-249** 180 mm  
**07-250** 200 mm



1/2

**07-251**  
 Probes



1/2

**07-252**  
 Double ended probe,  
 malleable, diam. of tips  
 3 mm with hole  
 190 mm



**07-253**  
 Double ended probes,  
 tin, malleable,  
 diam. of tips  
 3,5 mm with hole  
 250 mm, 300 mm



1/4

**07-254**  
 Double ended probes,  
 tin, malleable,  
 diam. of tips 4 mm  
 400 mm



1/3

**07-255** Ø tip 1,5 mm  
**07-256** 2,0 mm  
**07-257** 2,5 mm  
 300 mm

# Probes - Spatulas - Cotton Applicators

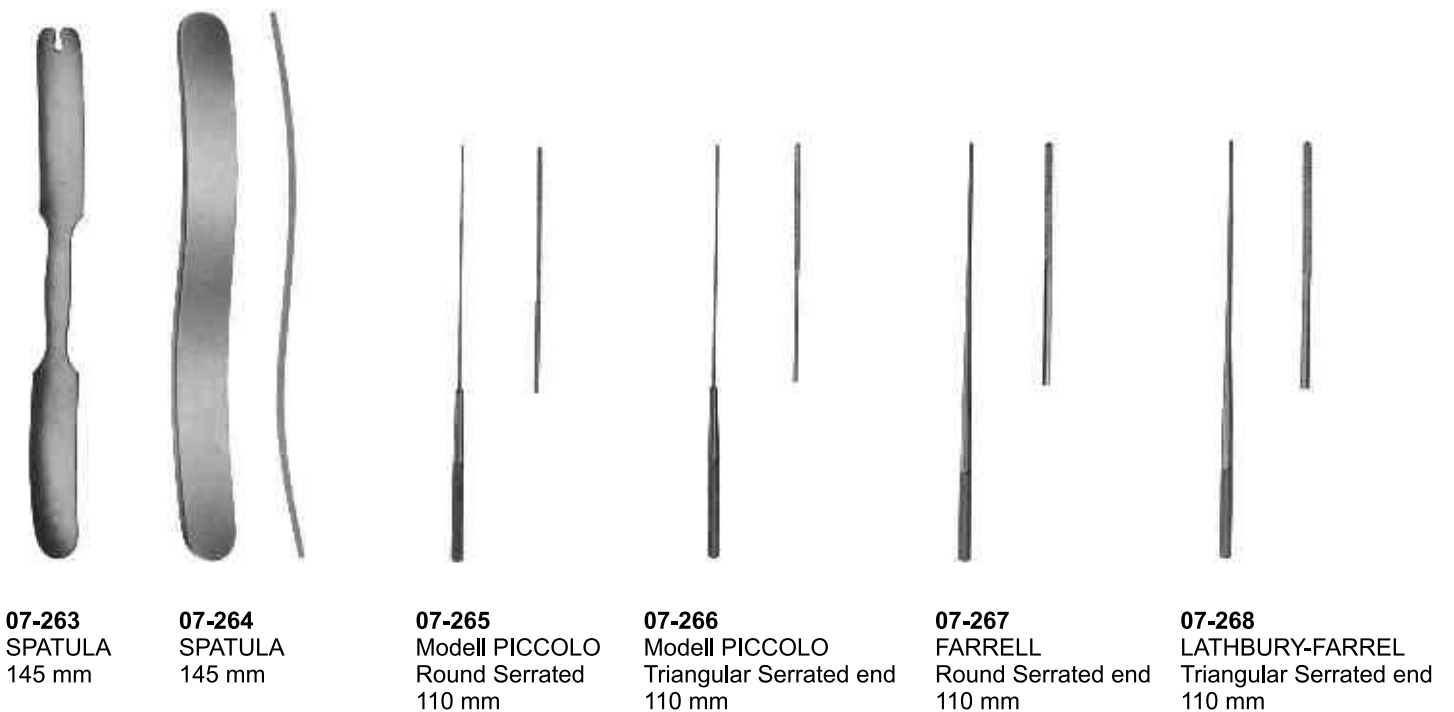
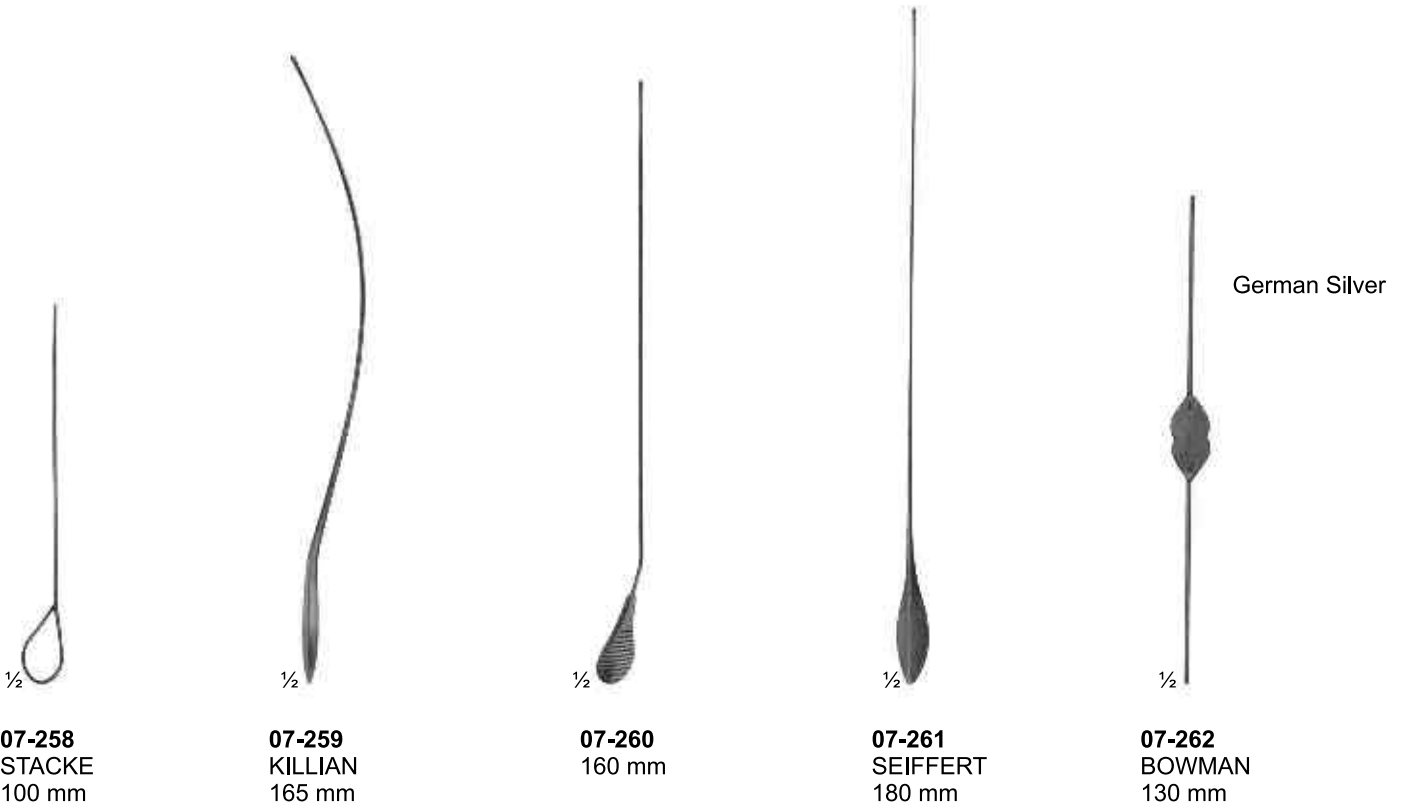

# Cotton Applicators



**07-269**  
BUCK  
Rough, spiral end  
120 mm

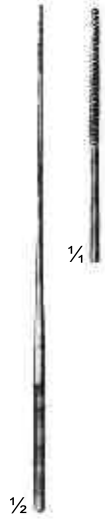

**07-270**  
Triangular  
serrated end  
140 mm

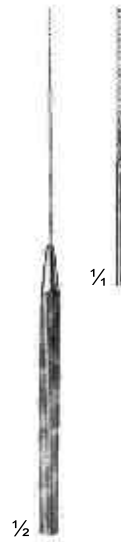

**07-271**  
Rough, spiral end  
140 mm



**07-272**  
Rough, spiral end  
140 mm

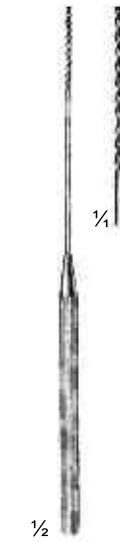

**07-273**  
Rough, spiral end  
140 mm



**07-274**  
FARRELL  
Round,  
serrated end  
140 mm



**07-275**  
LATHBURY-FARRELL  
Triangular,  
serrated end  
140 mm



**07-276**  
FARRELL  
Rough,  
spiral end  
160 mm



**07-277**  
LATHBURY-FARRELL  
Triangular,  
serrated end  
160 mm



**07-278**  
Triangular,  
serrated end  
160 mm

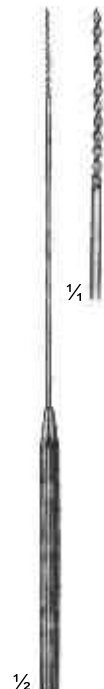

**07-279**  
Rough,  
spiral end  
180 mm

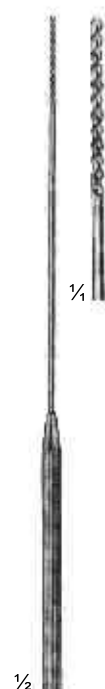

**07-280**  
Rough,  
spiral end  
180 mm



**07-281**  
Rough,  
spiral end  
270 mm

## Clip Applying Forceps - Suture Set



½

**07-282**  
MICHEL  
125 mm



½

**07-283**  
HEGENBARTH  
120 mm



½

**07-284**  
WACHENFELDT  
120 mm



½

**07-285**  
WACHENFELDT  
120 mm



½

**07-286**  
MICHEL  
125 mm



½

**07-287**  
MICHEL modif.  
130 mm



½

**07-288**  
HEATH  
135 mm



½

**07-289**  
COLLIN  
135 mm



## Clip Applying Forceps - Suture Set



### 07-290

Suturing instruments set, in metal case consisting of: Scissors, curved, sharp/sharp, 115mm  
25 MICHEL clip, 16 x 3mm  
1 Delicate tissue forceps, 130mm  
1 Scalpel, bellied  
1 MATHIEU needle holder, 140mm  
1 Perforated metal case, stainless containing:  
1 Suture needle  
1 item 1 item



### 07-291

Pocket instrument set, in metal case consisting of:

#### Bottom tray

1 MATHIEU needle holder, 140mm  
1 MICHEL clip forceps, combined  
1 Myrtle leaf probe, 130mm  
1 Sharp double curette  
1 Skin hook  
1 Detachable scalpel handle, no.4  
1 Perforated metal case, containing  
6 Scalpel blades BB 520  
1 Perforated metal case, stainless, containing  
1 Suture needle  
1 item  
1 item

#### Top tray

1 Tissue forceps, 130mm  
1 KOCHER haemostatic forceps, 130mm  
1 Straight surgical scissors, 130mm  
1 Dissecting forceps, 130mm  
1 FEILCHENFELD splinter forceps, 115mm  
25 MICHEL clip, 16 x 3mm  
1 Flacon of suture skin, sterile in alcohol



### 07-292

Pocket instrument set, in metal case consisting of:

#### Bottom tray

1 MAYO-HEGER needle holder, 150mm  
1 MICHEL clip forceps, combined  
1 Myrtle leaf probe, 130mm  
1 Sharp double curette  
1 Skin hook  
1 Detachable scalpel handle, no. 4  
1 Perforated metal case, consisting  
6 Scalpel blades BB 520  
1 Perforated metal case, stainless, consisting:  
1 Suture needle  
1 item, & 1 item

#### Bottom tray

1 Tissue forceps, 130mm  
1 CRILE haemostatic forceps, 140mm  
1 Straight surgical scissors, 130mm  
1 Dissecting forceps, 130mm  
1 FEILCHENFELD splinter forceps, 115mm  
25 MICHEL clip, 16 x 3mm  
1 Flacon of suture silk, sterile in alcohol



## Clip Applying Forceps - Suture Set

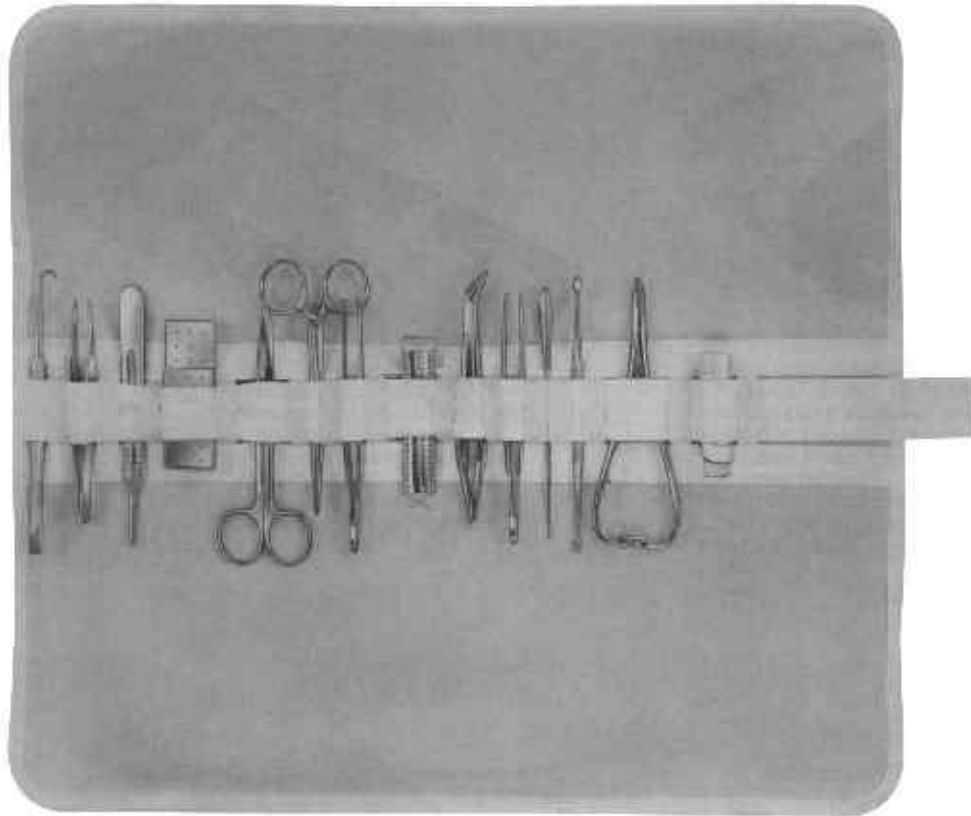

### 07-293

Pocket instrument set in metal case 170 x 90mm with sterilizable canvas roll consisting of:

- 1 Myrtle leaf probe, 130mm
- 1 Sharp double curette
- 1 FEILCHENFELD splinter forceps, 115mm
- 1 Dissecting forceps, 130mm
- 1 Tissue forceps, 130mm

- 1 Straight surgical scissors, 130mm
- 1 Scalpel handle no. 4
- 1 Perforated metal case, consisting of 6 scalpel blades BB 520
- 1 KOCHER haemostatic forceps, 130mm
- 1 Skin hook
- 1 MATHIEU needle holder, 140mm
- 1 Tube of suture skin, sterile in alcohol
- 1 MICHEL clip forceps, 120mm

- 25 MICHEL clip, 16 x 3mm**
- 1 Perforated metal case, stainless, consisting:**
- 1 Suture needle**
- 1 item**
- 1 item**

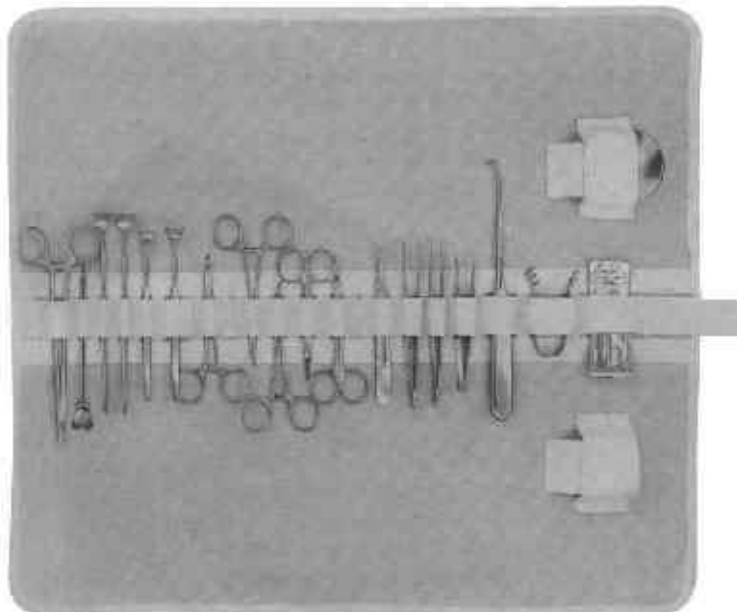

### 07-294

Venae sectio set, in sterilizable canvas roll consisting of:

- 1 Tissue forceps, 1 x 2 teeth, 140mm
- 1 Dissecting forceps, 145mm
- 1 FEILCHENFELD straight scissors, sharp, 110mm
- 1 curved scissors, blunt, 115mm
- 1 HALSTED mosquito forceps, curved on flat, 125mm

- 1 DESCHAMPS needle, blunt, 210mm
- 1 DOYEN Director, curved, 140mm
- 2 Wound retractors, 4 blunt prongs, 160mm
- 2 DESMARRES wound retractors, 135mm
- 1 FINSEN retractors, 2 x3 blunt prongs, 80mm

- 1 Scalpel handle no. 4
- 4 Sterile scalpel blades, no 18, single peel pack
- 1 Needle box, perforated, round, diam. 65mm
- 1 HEGAR-MAYO DUROGRIP needle holder, 180mm



## Clip Applying Forceps - Suture Set

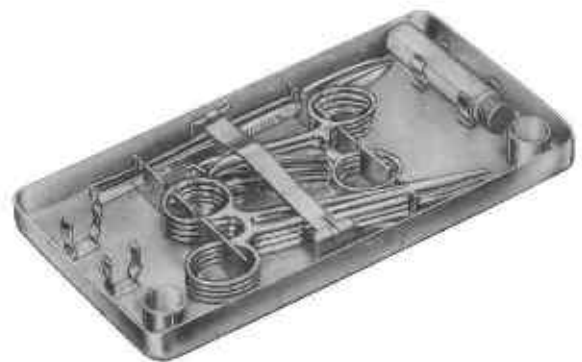

### 07-295

Venae sectio set, in metal case  
consisting of:

#### Bottom tray

- 1 MATHIEU needle holder, fine pattern 140mm
- 1 Ligature needle, fine short pattern
- 1 DOYEN director, curved
- 1 HEGENBARTH clip forceps,
- 1 ELSCHNIG tissue forceps, 1 x 2 teeth fine, 150mm
- 1 Dressing forceps, fine 105mm
- 1 Tissue forceps, 1 x 2 teeth, 110mm
- 1 Vessel scissors, straight, with 1 ball point, 110mm
- 1 Vessel scissors, curved, pointed 105mm
- 1 FINSSEN retractor
- 1 Perforated needle case

#### Top tray

- 1 Scalpel, pointed
- 1 Scalpel, bellied
- 2 HALSTED mosquito forceps, curved, 125mm
- 2 HALSTED mosquito forceps, straight, 1x 2 teeth, 125mm
- 3 BACKHAUS towel forceps, 90mm
- 2 Flacon holder

# Nerve - and Vessel Hooks

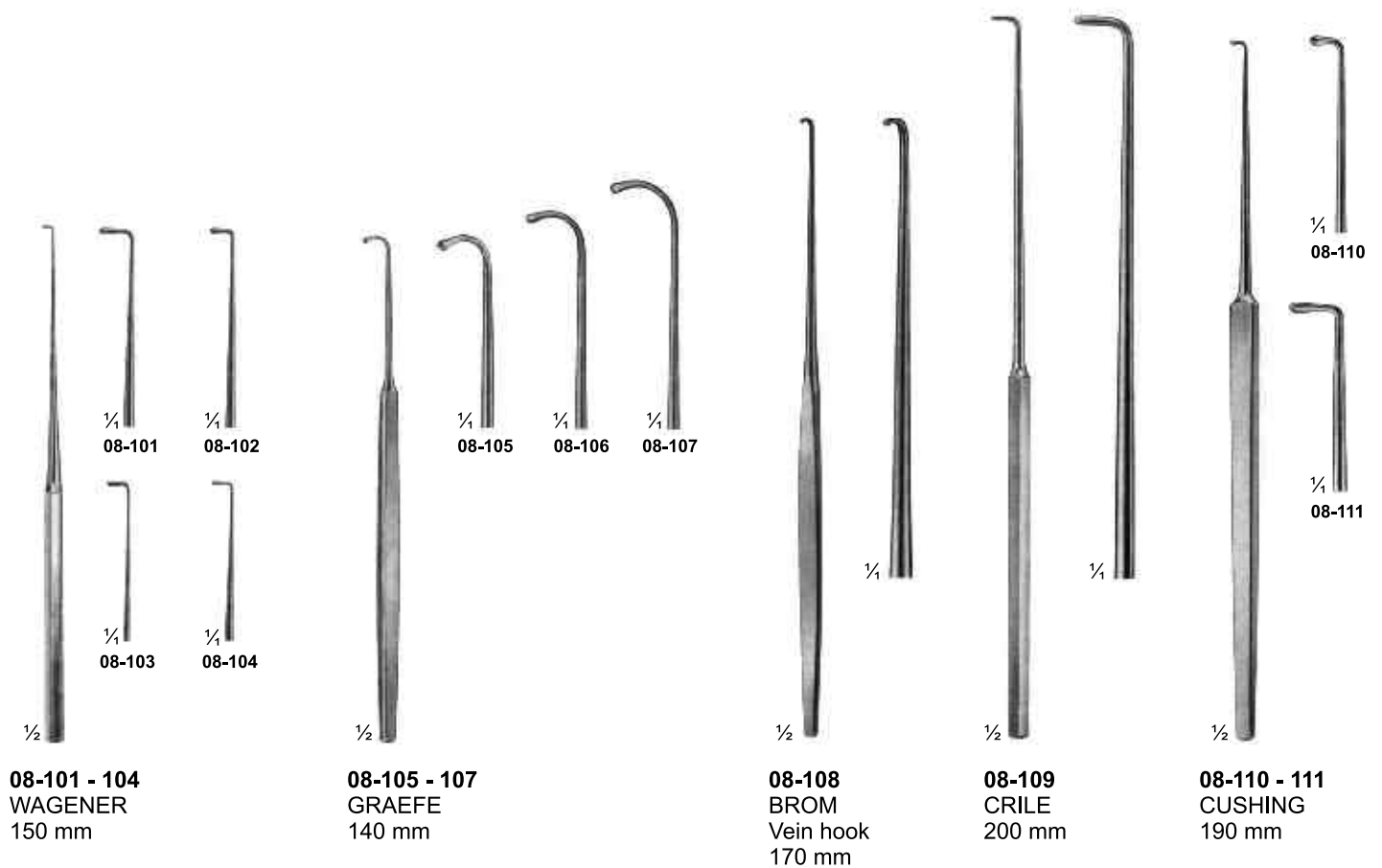

# Nerve - and Vessel Hooks

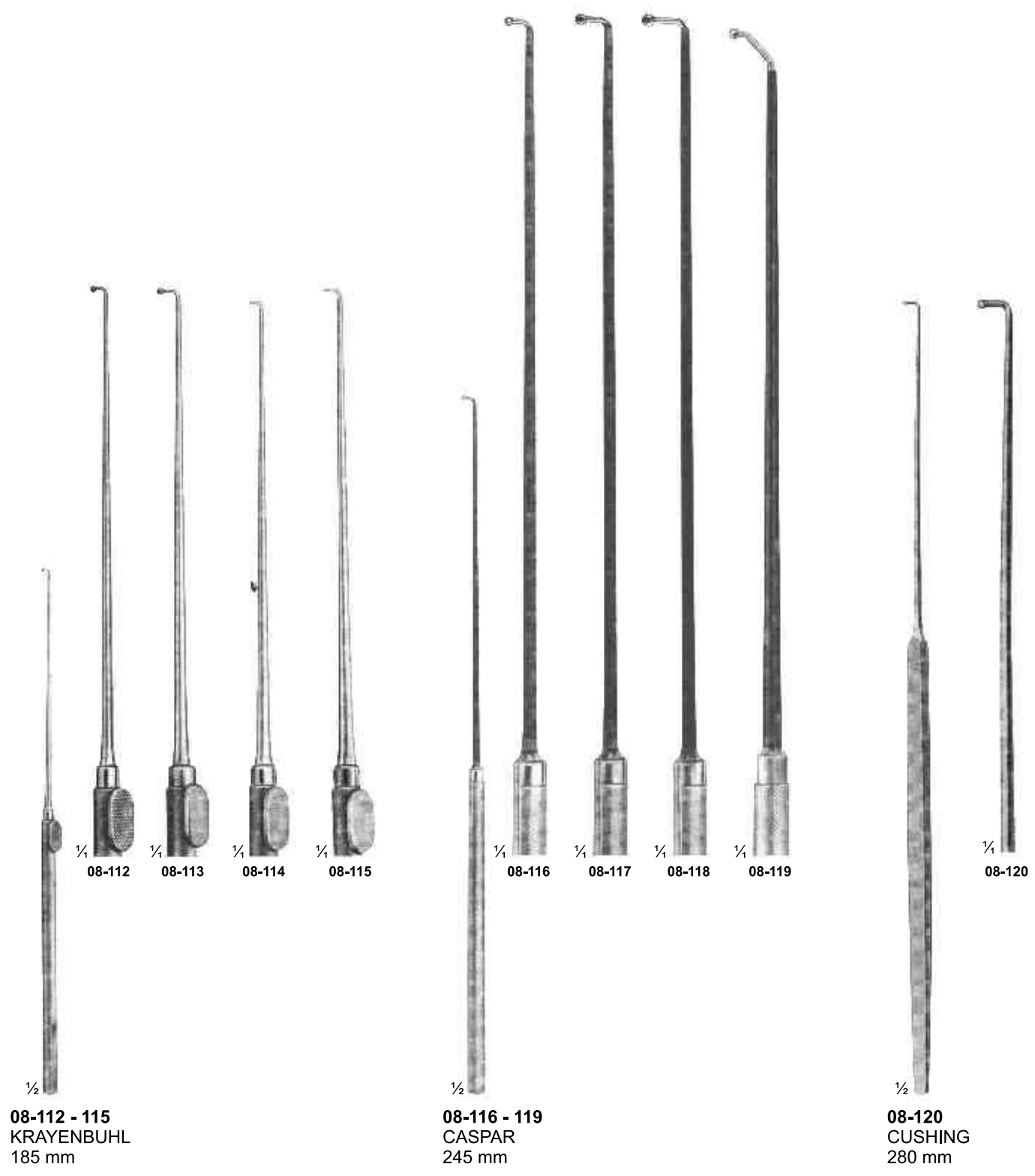

**08-112 - 115**  
KRAYENBUHL  
185 mm

**08-116 - 119**  
CASPAR  
245 mm

**08-120**  
CUSHING  
280 mm

# Fine Wound Retractors (Dura- and Skin Retractors)

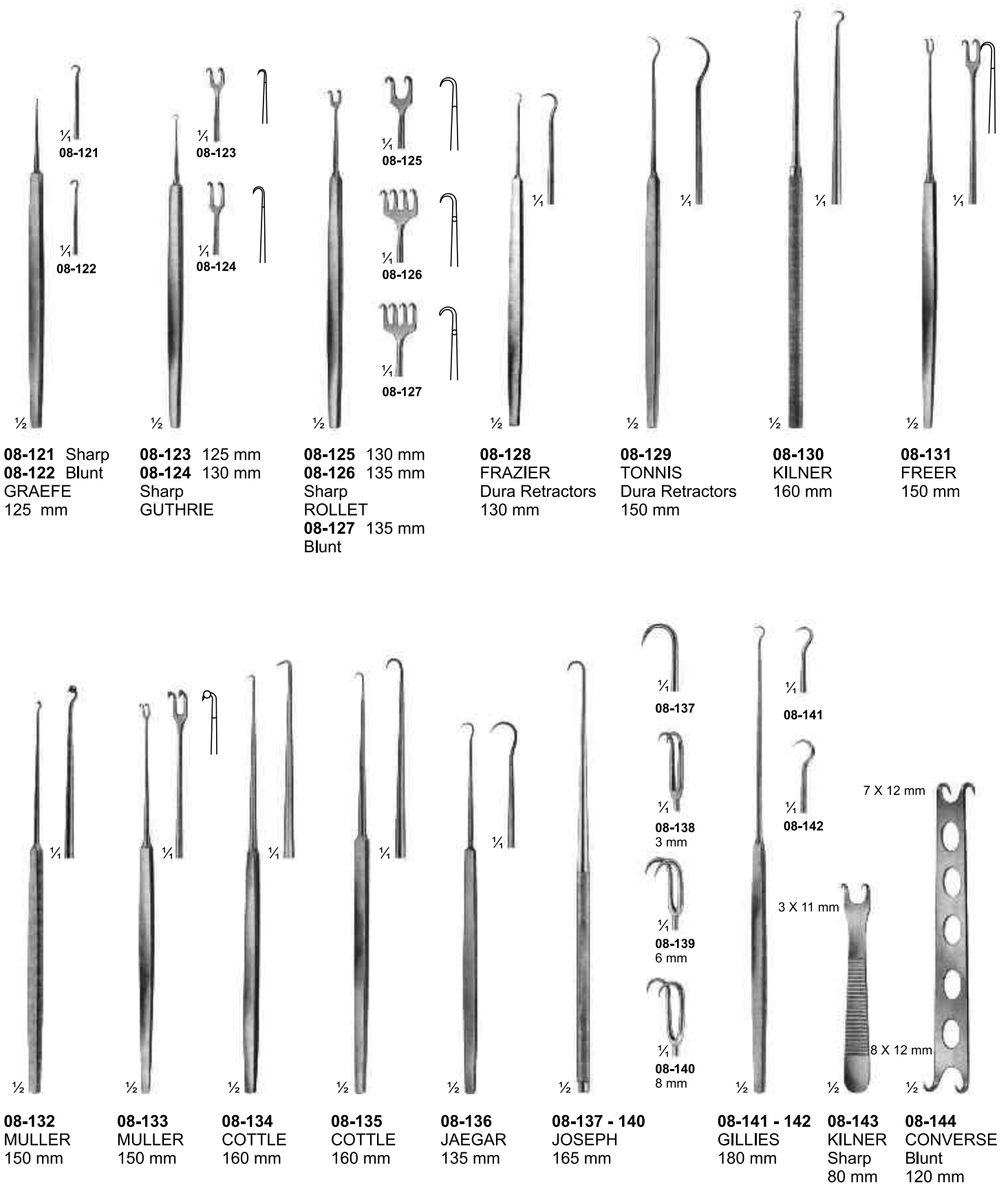

# Wound - Trachea Retractors

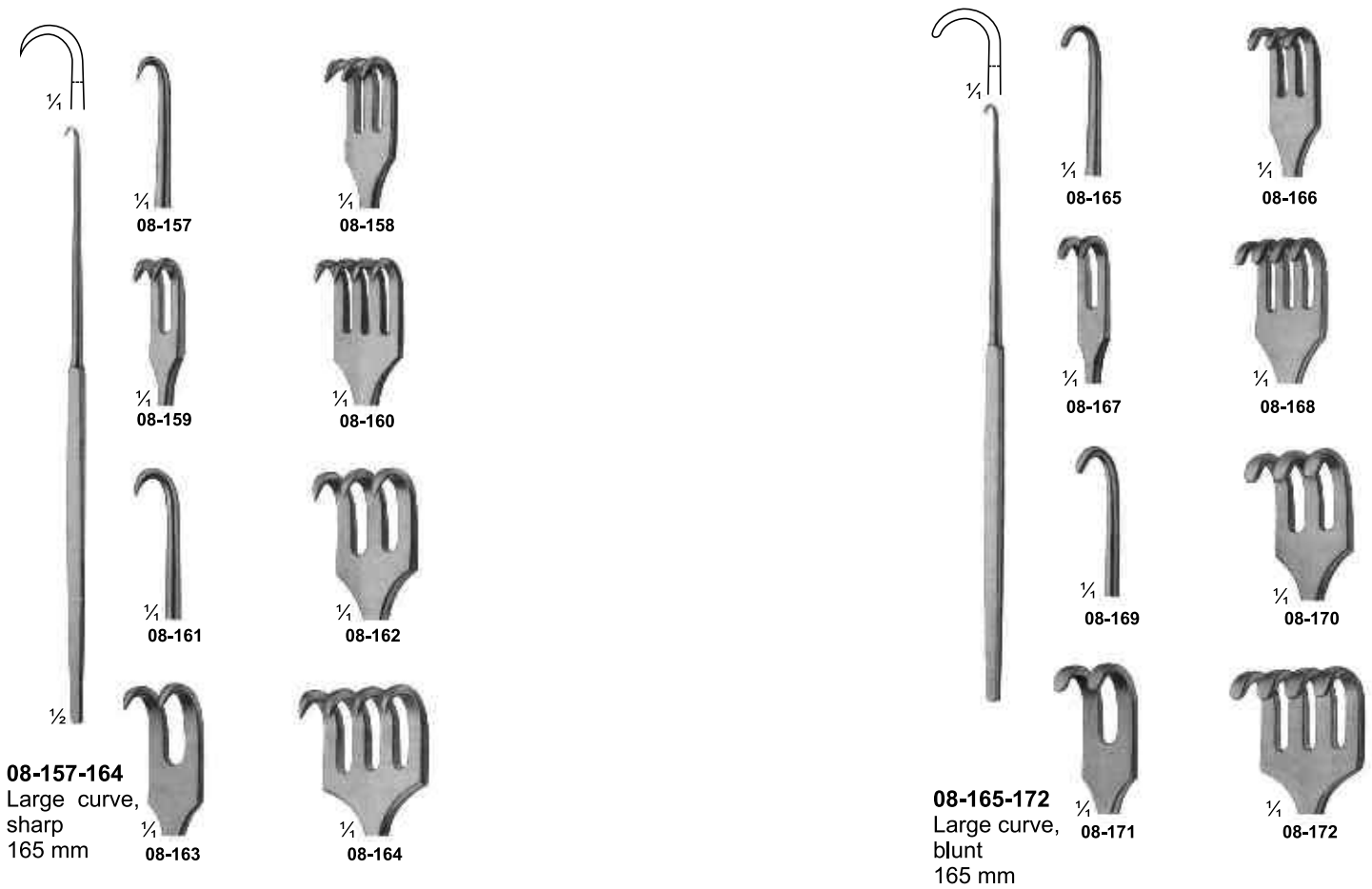



# Retractors With Treangle Handle

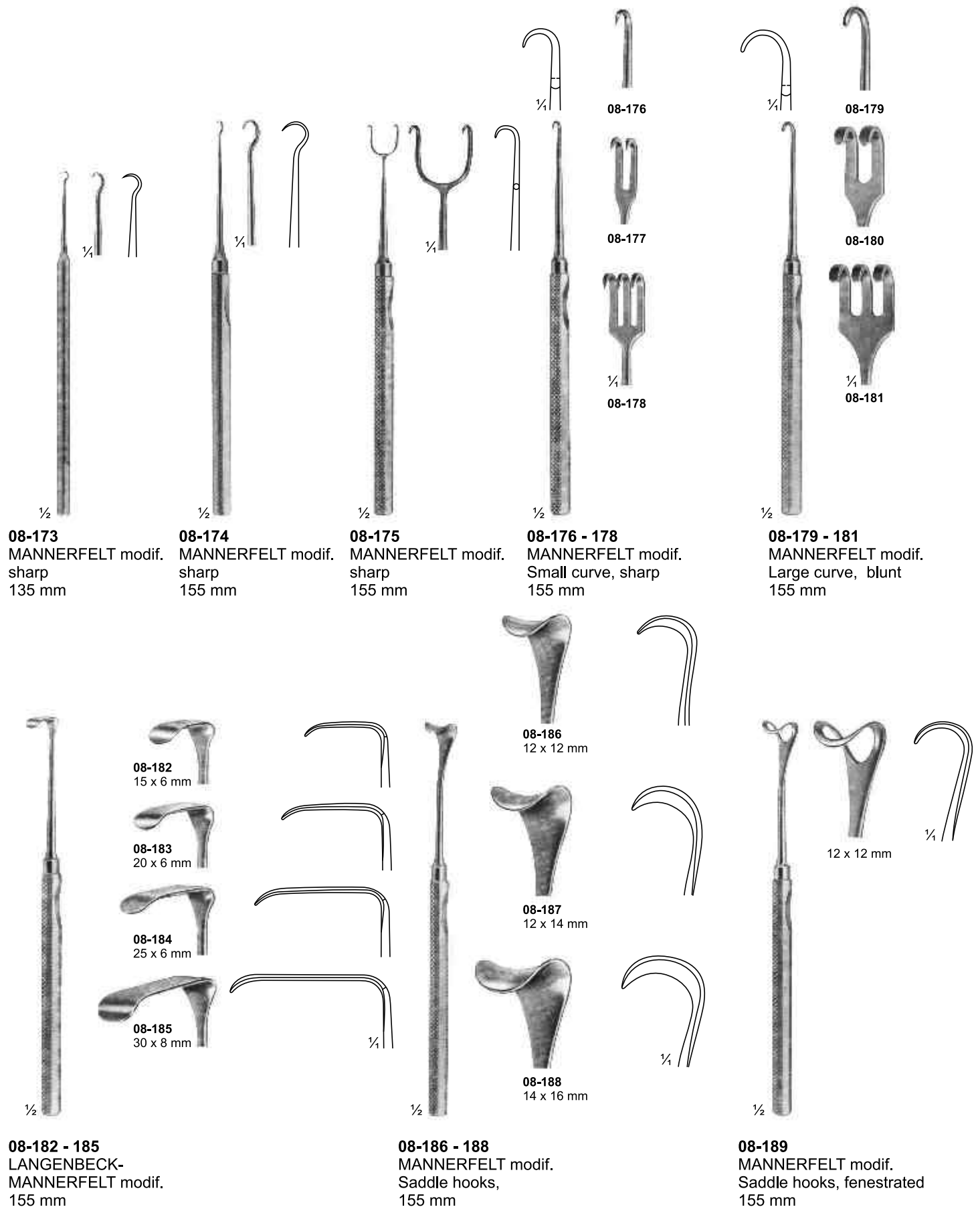



# Retractors



½  
**08-190**  
FOMON  
145 mm



½  
**08-191 - 192**  
160 mm



½  
**08-193 - 194**  
LANGENBECK-GREEN  
160 mm

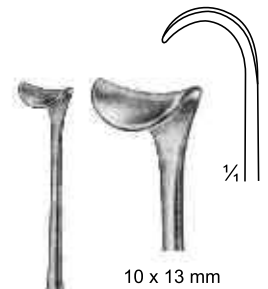

½  
**08-195**  
160 mm

10 x 13 mm

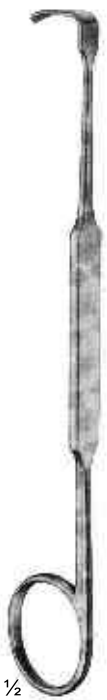

½  
**08-196 - 201**  
MEYERDING  
Fig. A - Fig. F  
180 mm

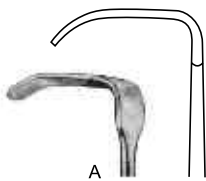

**A**  
**08-196**  
18 x 7 mm

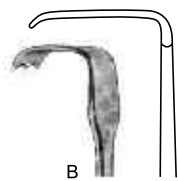

**B**  
**08-197**  
16 x 5 mm



**C**  
**08-198**  
7 x 4 mm

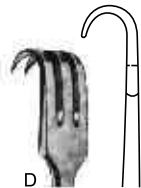

**D**  
**08-199**  
5 x 10 mm



**E**  
**08-200**  
11 x 4 mm



**F**  
**08-201**  
6 x 4 mm

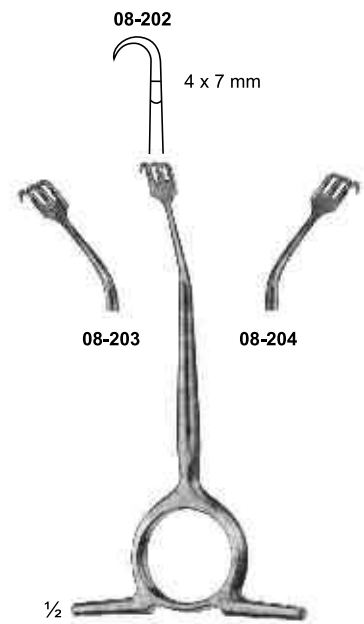

½  
**08-202 - 204**  
WILLIGER  
120 mm

**08-202**  
4 x 7 mm

**08-203**

**08-204**

# Retractors



**08-205**  
EMMET  
Fistula hook  
220 mm



**08-206**  
SIMON  
Fistula hook  
220 mm

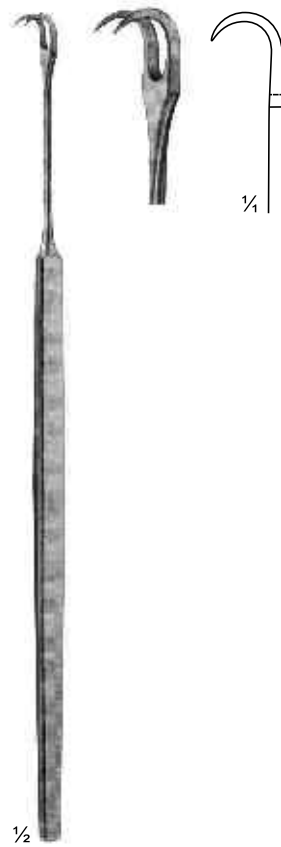

**08-207**  
SIMON  
Fistula hook  
220 mm



**08-208**  
LANGE  
Fistula hook  
230 mm

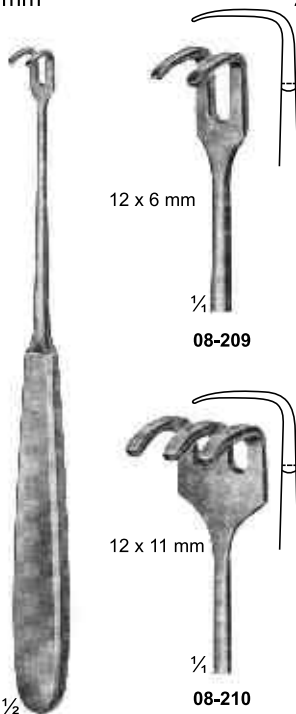

**08-209 - 210**  
Tendon hooks  
175 mm

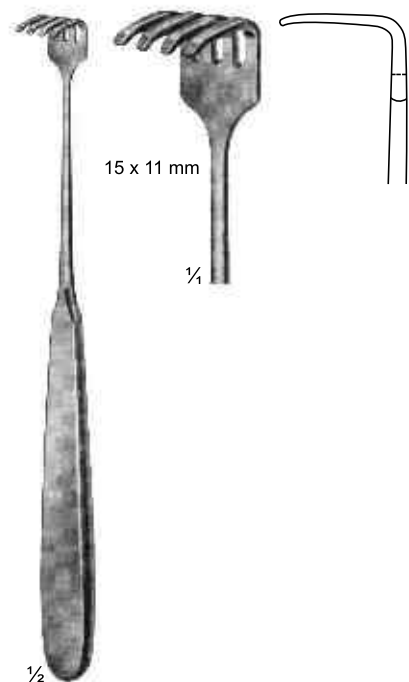

**08-211**  
KLAPP  
Tendon hooks  
175 mm

# Retractors



1/4  
6 x 12 mm

1/2  
**08-212**  
MASING  
140 mm

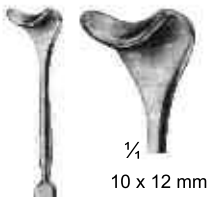

1/4  
10 x 12 mm

1/2  
**08-213**  
COTTLE  
140 mm



**08-214**  
9 x 9 mm

1/2  
**08-214 - 218**  
DESMARRES  
140 mm



**08-215**  
9 x 12 mm

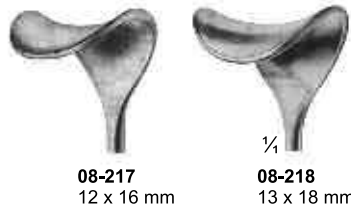

**08-217**  
12 x 16 mm



1/4  
**08-216**  
11 x 14 mm



1/4  
**08-218**  
13 x 18 mm

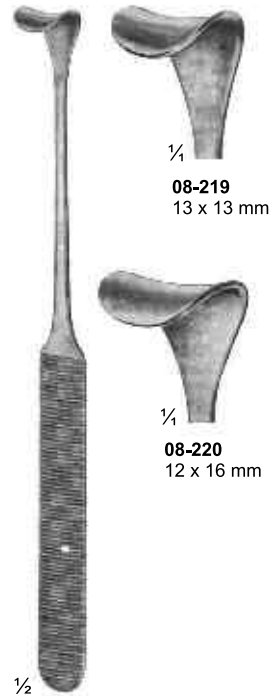

1/4  
**08-219**  
13 x 13 mm

1/2  
**08-219 - 220**  
KONIG  
180 mm



1/4  
10 x 10 mm

1/2  
**08-221**  
CUSHING-KOCHER  
175 mm

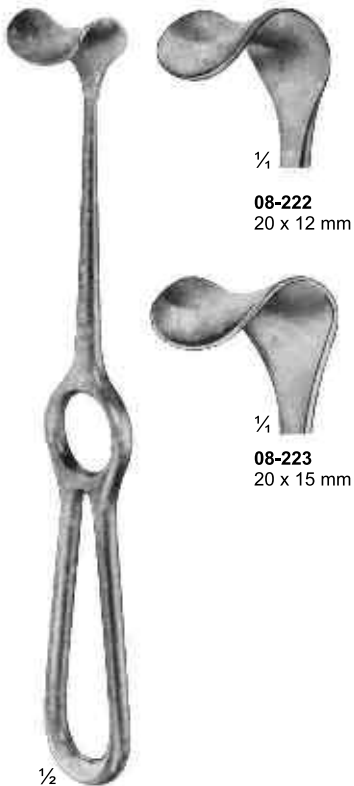

1/4  
**08-222**  
20 x 12 mm

1/2  
**08-222 - 223**  
KOCHER  
205 mm

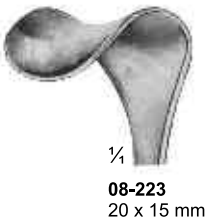

1/4  
**08-223**  
20 x 15 mm

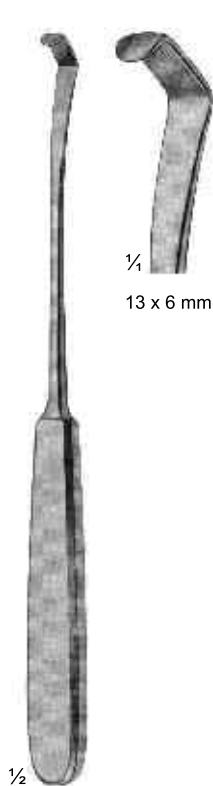

1/4  
13 x 6 mm

1/2  
**08-224**  
SCHOENBORN  
200 mm

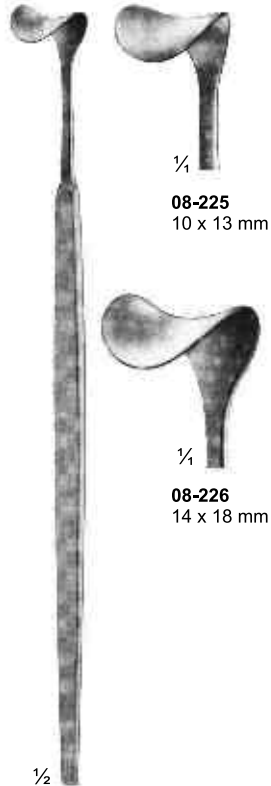

1/4  
**08-225**  
10 x 13 mm

1/2  
**08-225 - 226**  
CUSHING  
205 mm



1/4  
**08-226**  
14 x 18 mm



20 x 15 mm

1/2  
**08-227**  
205 mm



1/4  
**08-228**  
11 x 14 mm

1/2  
**08-228 - 230**  
CUSHING  
250 mm



1/4  
**08-229**  
13 x 18 mm

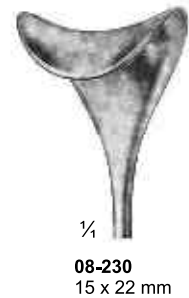

1/4  
**08-230**  
15 x 22 mm

# Retractors

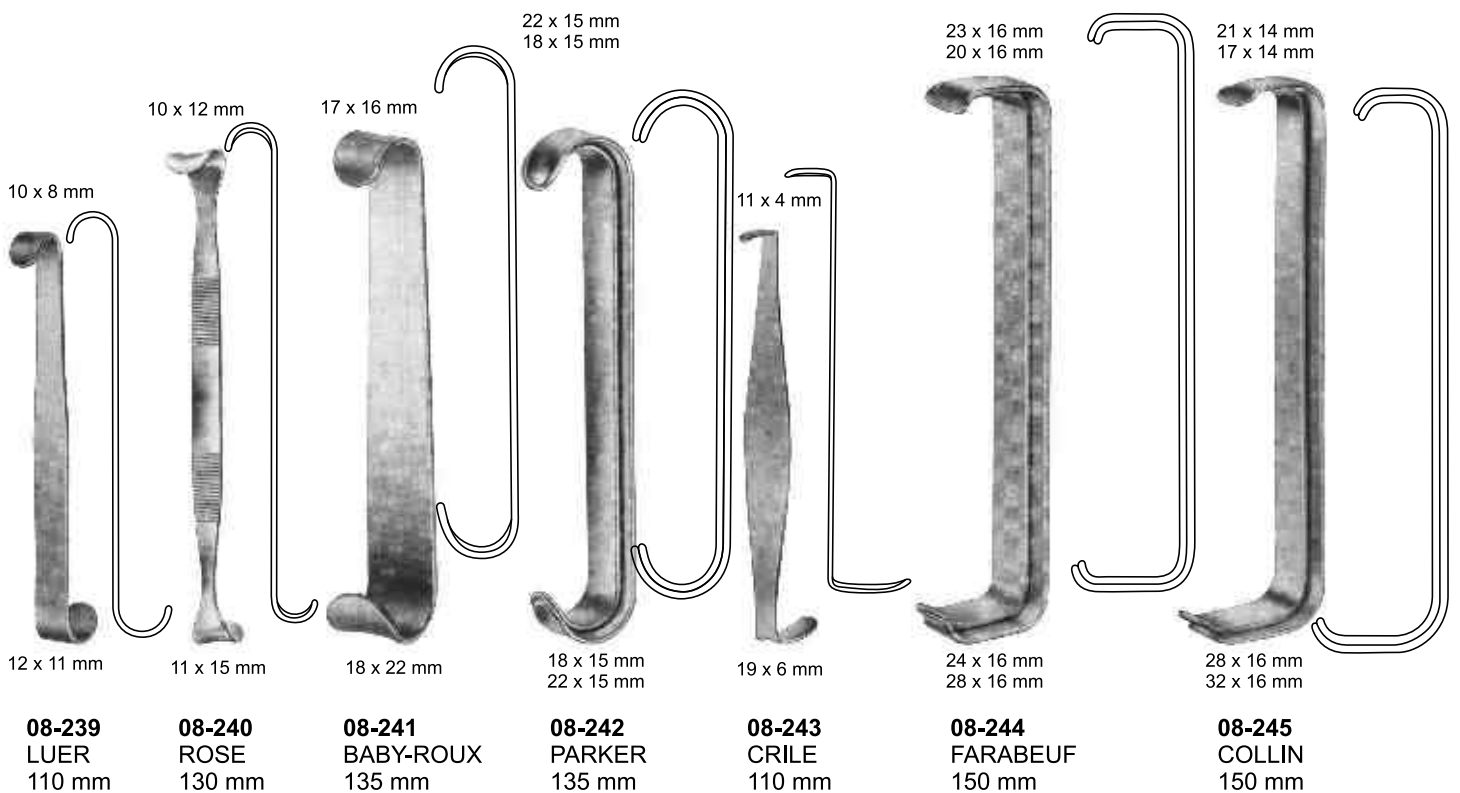

# Retractors

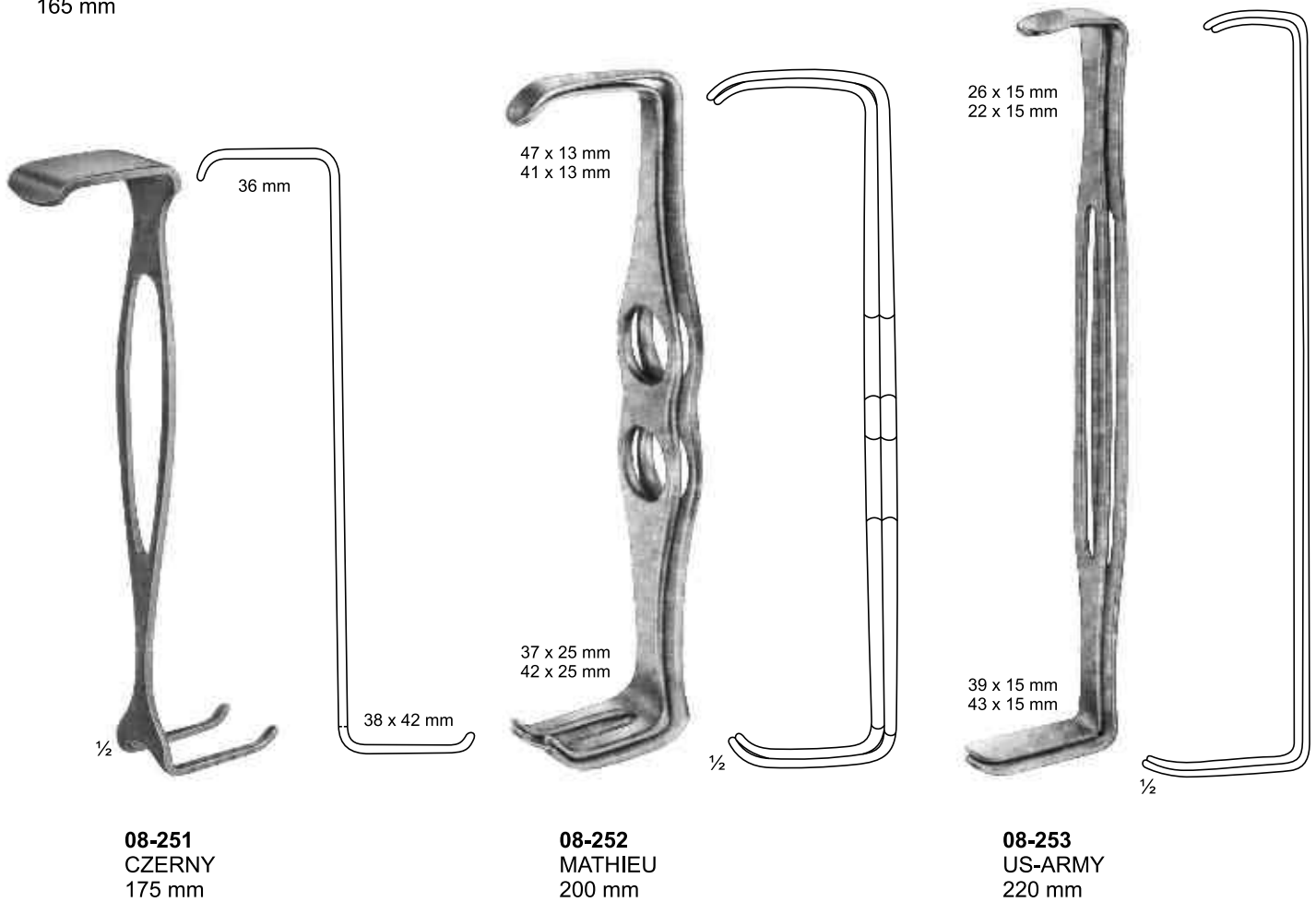
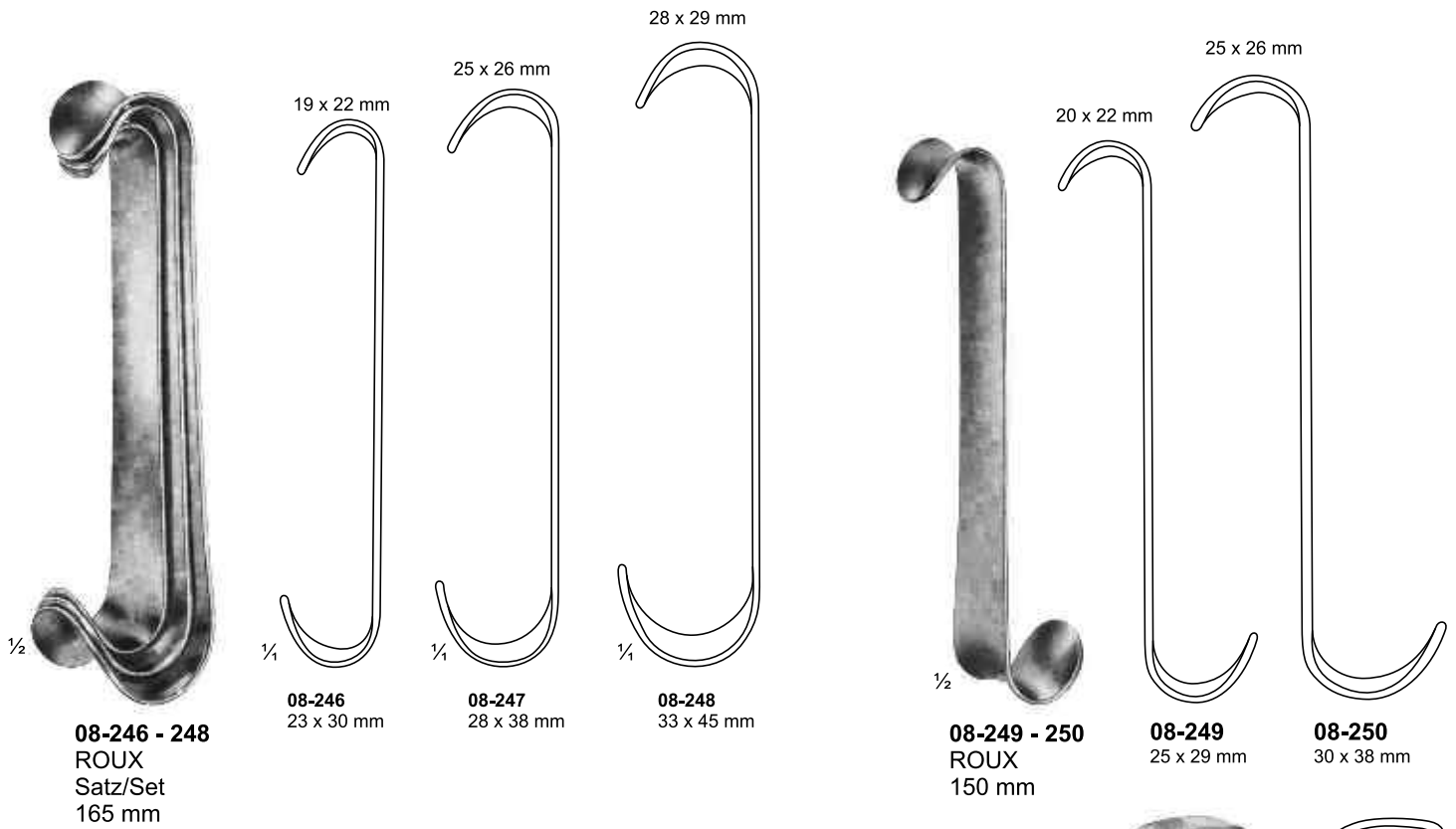

# Bone Retractors and Retractors



**08-254**  
KOCHER  
Sharp  
205 mm



**08-255**  
KOCHER  
Sharp  
220 mm



**08-256**  
KOCHER  
Blunt  
220 mm



**08-257**  
VOLKMANN  
Sharp  
220 mm



**08-258**  
VOLKMANN  
Sharp  
220 mm



**08-259 - 266**  
VOLKMANN  
225 mm

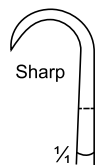

Sharp

1/4

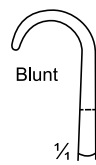

Blunt

1/4



**08-259**  
9 x 8 mm



**08-260**  
9 x 13 mm



**08-261**  
9 x 19 mm



**08-262**  
9 x 29 mm



**08-263**  
8,5 x 8 mm



**08-264**  
8,5 x 13 mm



**08-265**  
8,5 x 19 mm



**08-266**  
8,5 x 29 mm

# Retractors

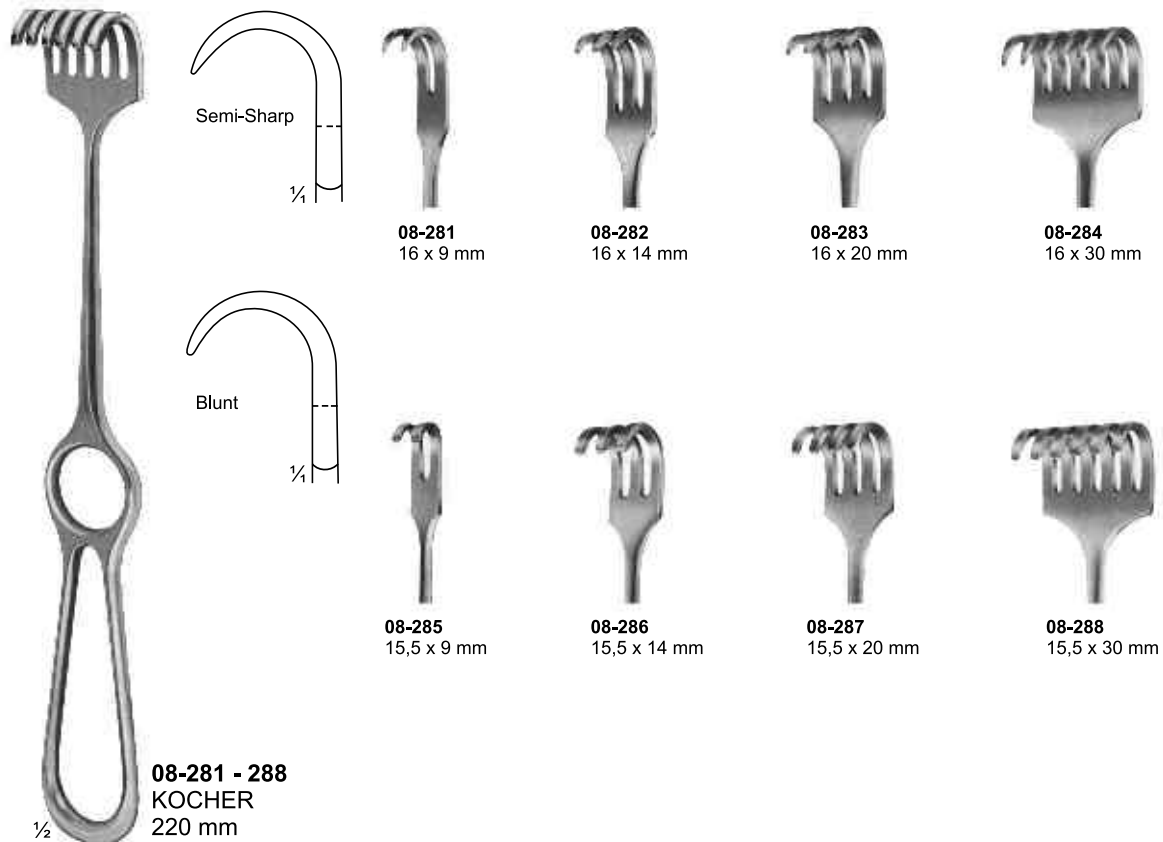
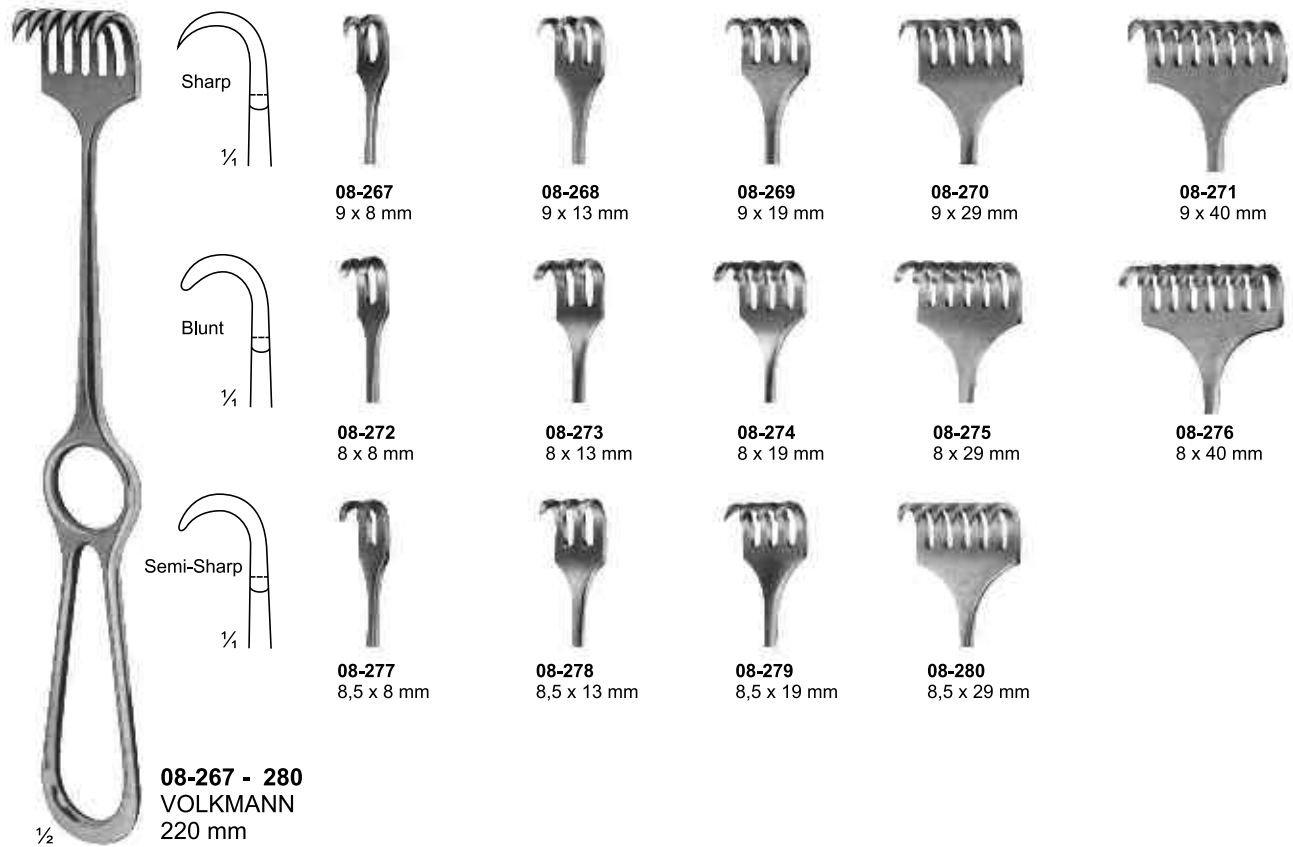



# Retractors, Deep form



**08-289 - 290**  
KORTE  
240 mm



**08-289**  
8 Prongs, blunt



**08-290**  
8 Prongs, sharp



**08-291 - 294**  
ISRAEL  
255 mm

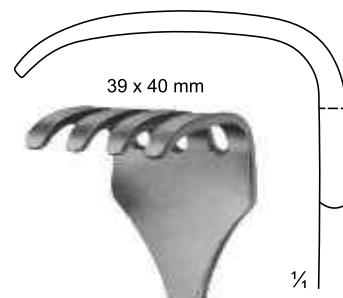

**08-291**  
4 Prongs, blunt

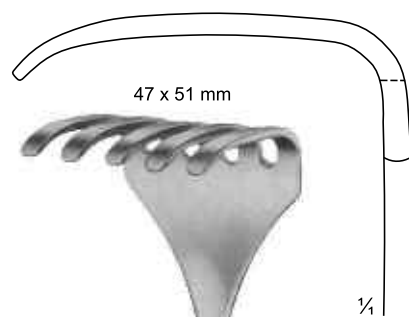

**08-292**  
5 Prongs, blunt

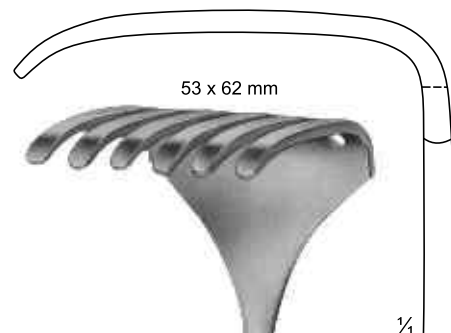

**08-293**  
6 Prongs, blunt

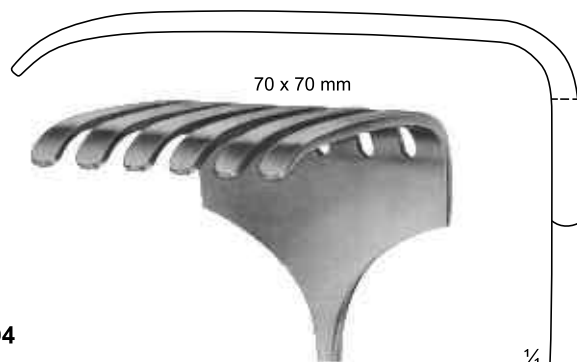

**08-294**  
6 Prongs, blunt



# Retractors

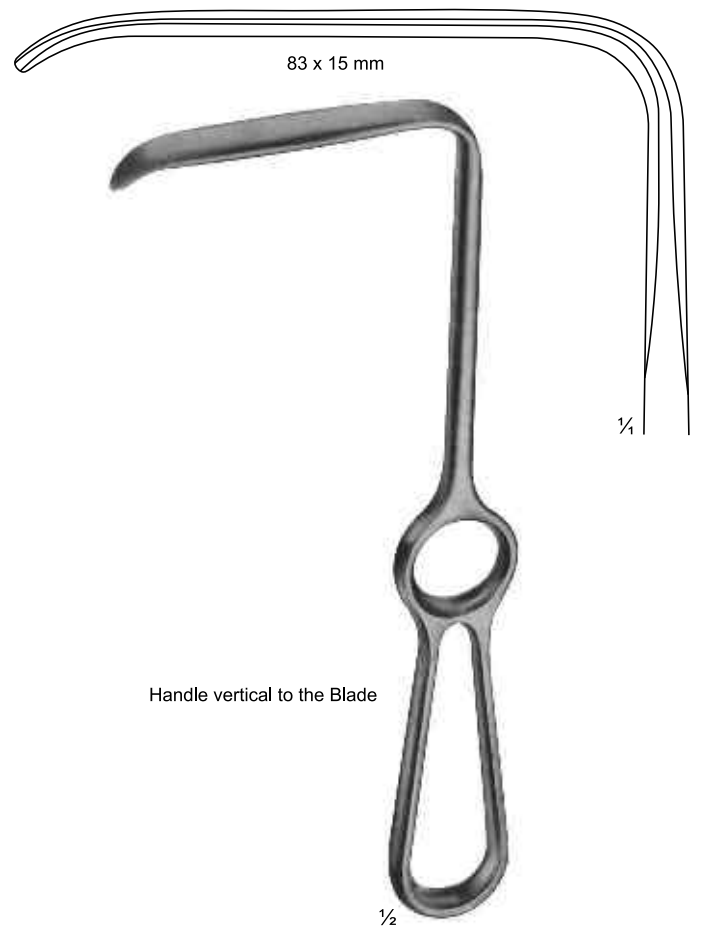

**08-295 - 300**  
LANGENBECK  
210 mm  
**08-295** 28 x 10 mm  
**08-296** 28 x 14 mm  
**08-297** 33 x 14 mm  
**08-298** 28 x 16 mm  
**08-299** 40 x 10 mm  
**08-300** 40 x 13 mm

**08-301 - 307**  
KOCHER-LANGENBECK  
215 mm  
**08-301** 25 x 6 mm  
**08-302** 35 x 8 mm  
**08-303** 35 x 11 mm  
**08-304** 35 x 15 mm  
**08-305** 41 x 11 mm  
**08-306** 55 x 11 mm  
**08-307** 70 x 14 mm

**08-308**  
LANGENBECK  
215 mm

# Retractors



**08-309 - 313**  
KOCHER  
230 mm



**08-314 - 316**  
SAUERBRUCH  
225 mm

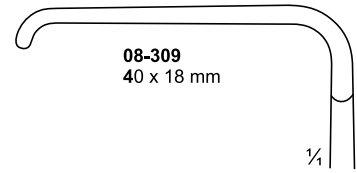

**08-309**  
40 x 18 mm

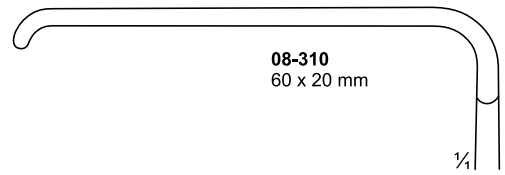

**08-310**  
60 x 20 mm

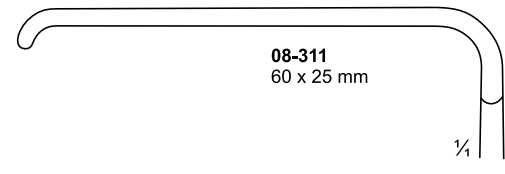

**08-311**  
60 x 25 mm

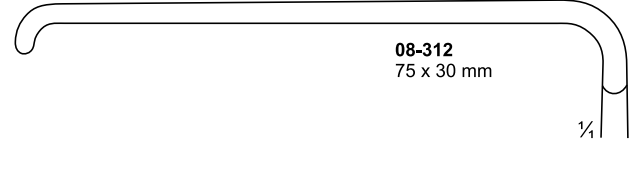

**08-312**  
75 x 30 mm

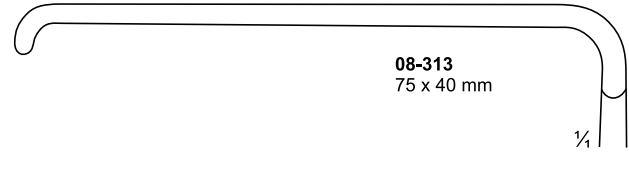

**08-313**  
75 x 40 mm

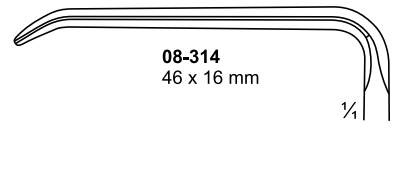

**08-314**  
46 x 16 mm

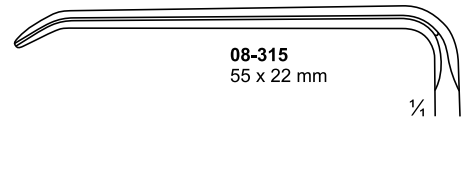

**08-315**  
55 x 22 mm

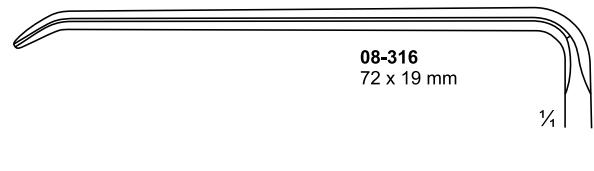

**08-316**  
72 x 19 mm

# Retractors

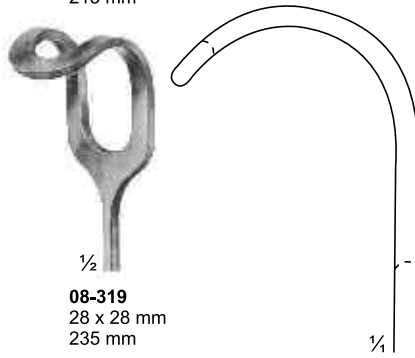
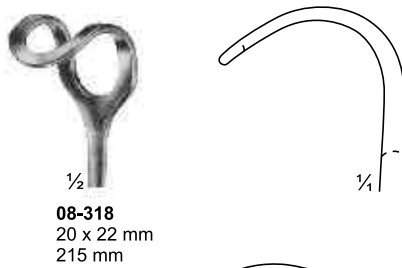

1/2  
**08-317 - 319**  
 MIDDELDORPF

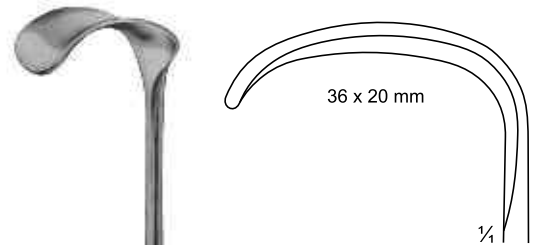

1/2  
**08-321**  
 CASPAR  
 210 mm

1/2  
**08-322**  
 KOCHER  
 230 mm

# Retractors



½

**08-323 - 328**  
HOSEL  
250 mm

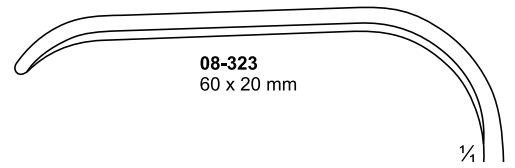

**08-323**  
60 x 20 mm

¼

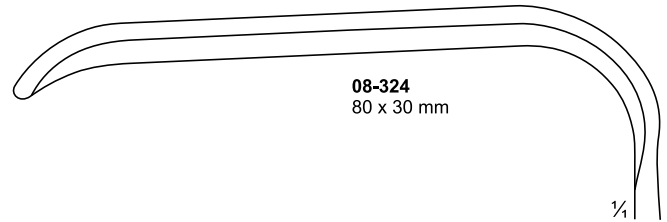

**08-324**  
80 x 30 mm

¼

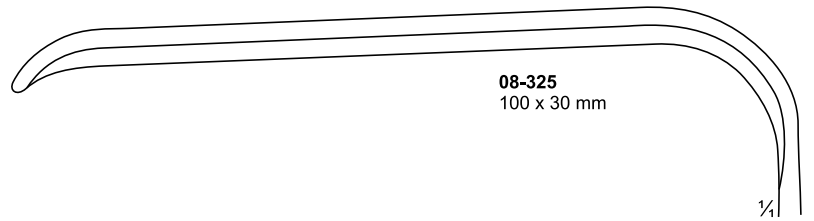

**08-325**  
100 x 30 mm

¼

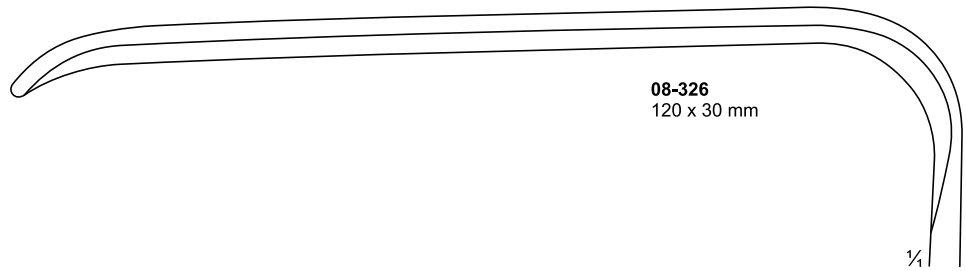

**08-326**  
120 x 30 mm

¼

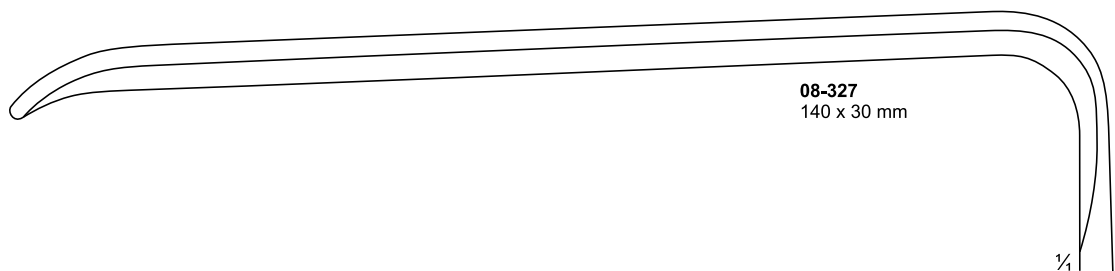

**08-327**  
140 x 30 mm

¼

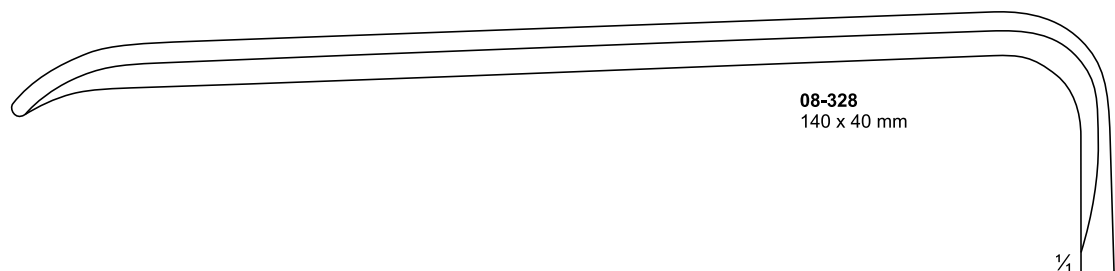

**08-328**  
140 x 40 mm

¼

# Retractors

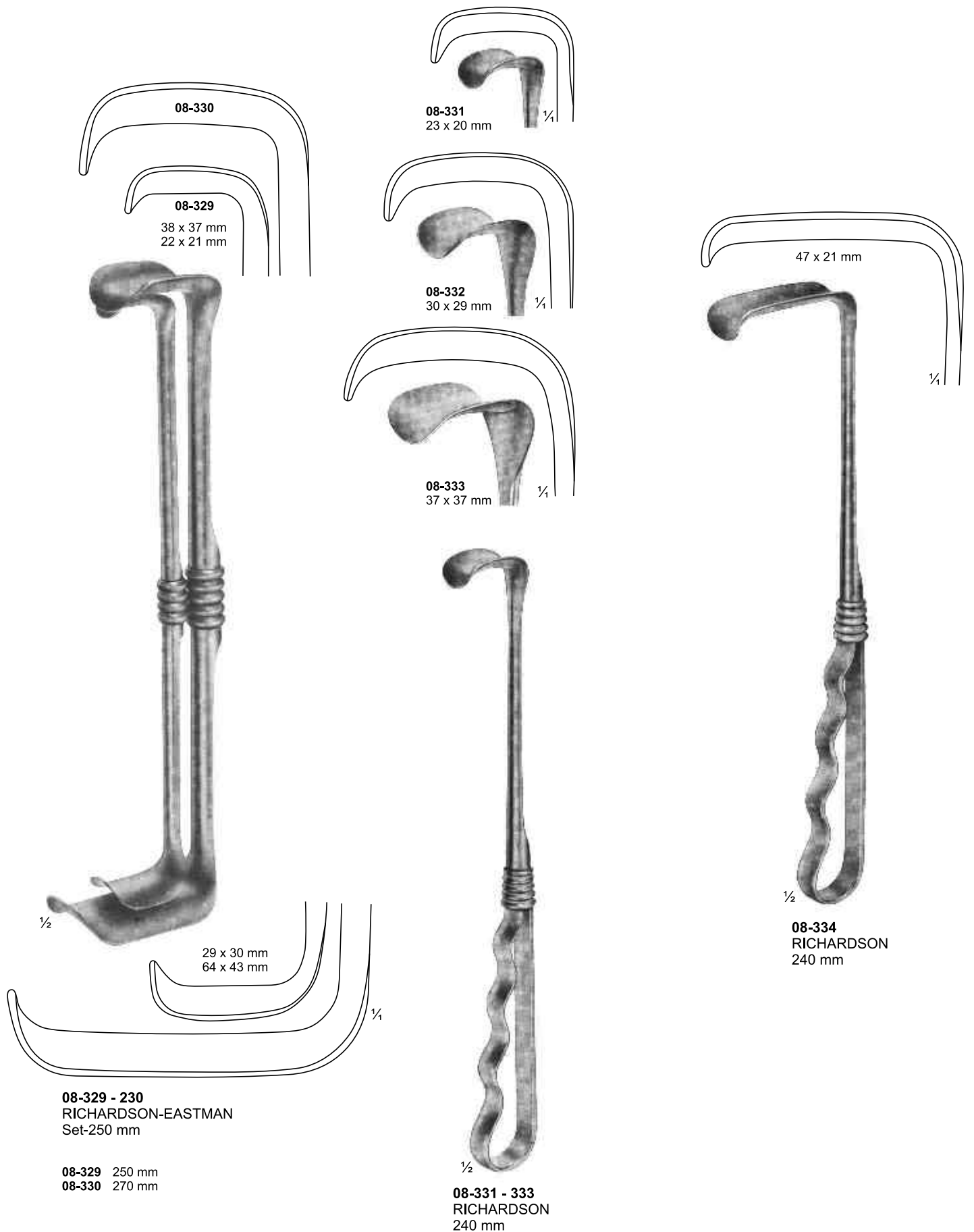

# Retractors

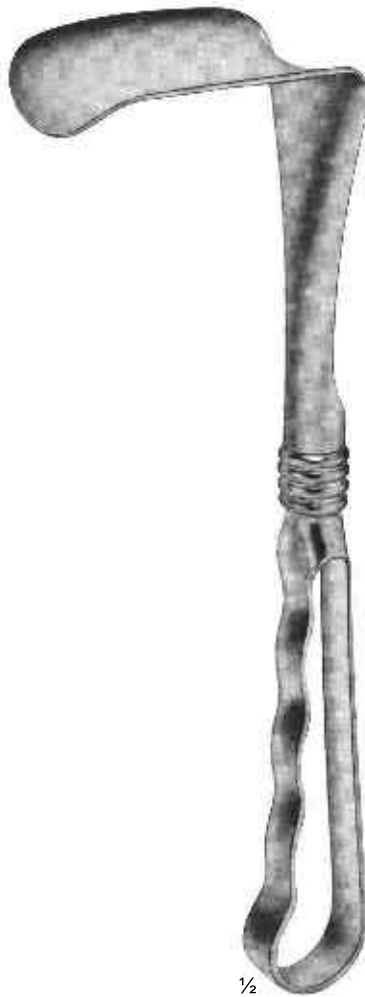
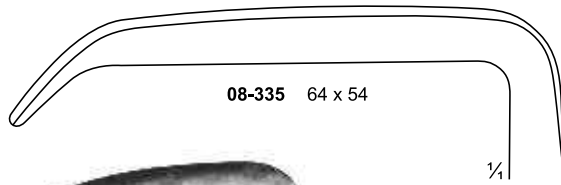
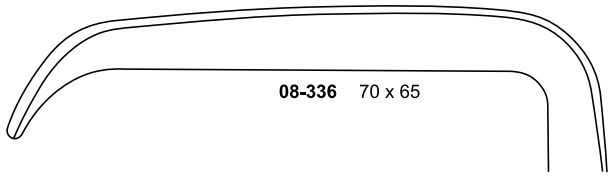

**08-335 - 336**  
**KELLY**  
 260 mm

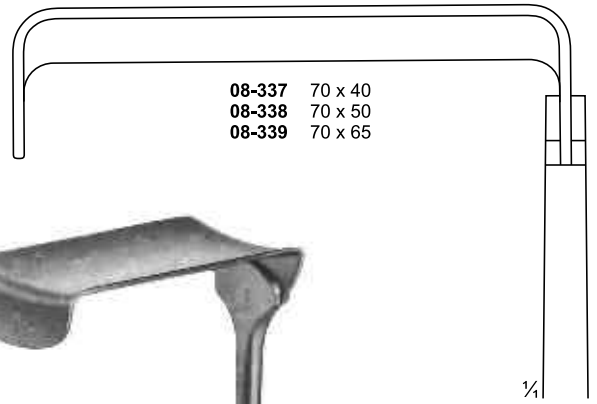

**08-337 - 339**  
**MORRIS**  
 245 mm

# Retractors For Deep Surgery

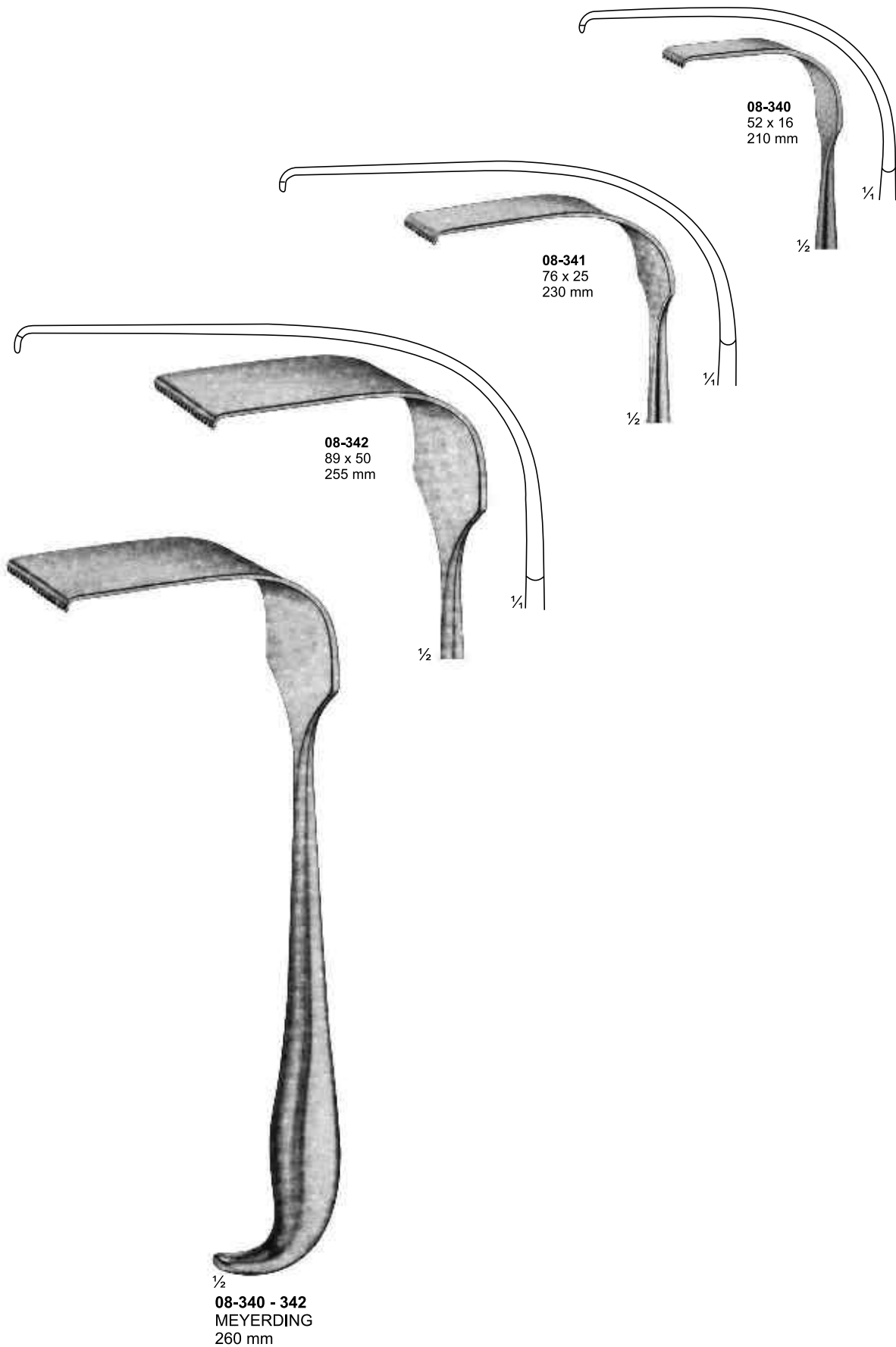

# Retractors For Deep Surgery

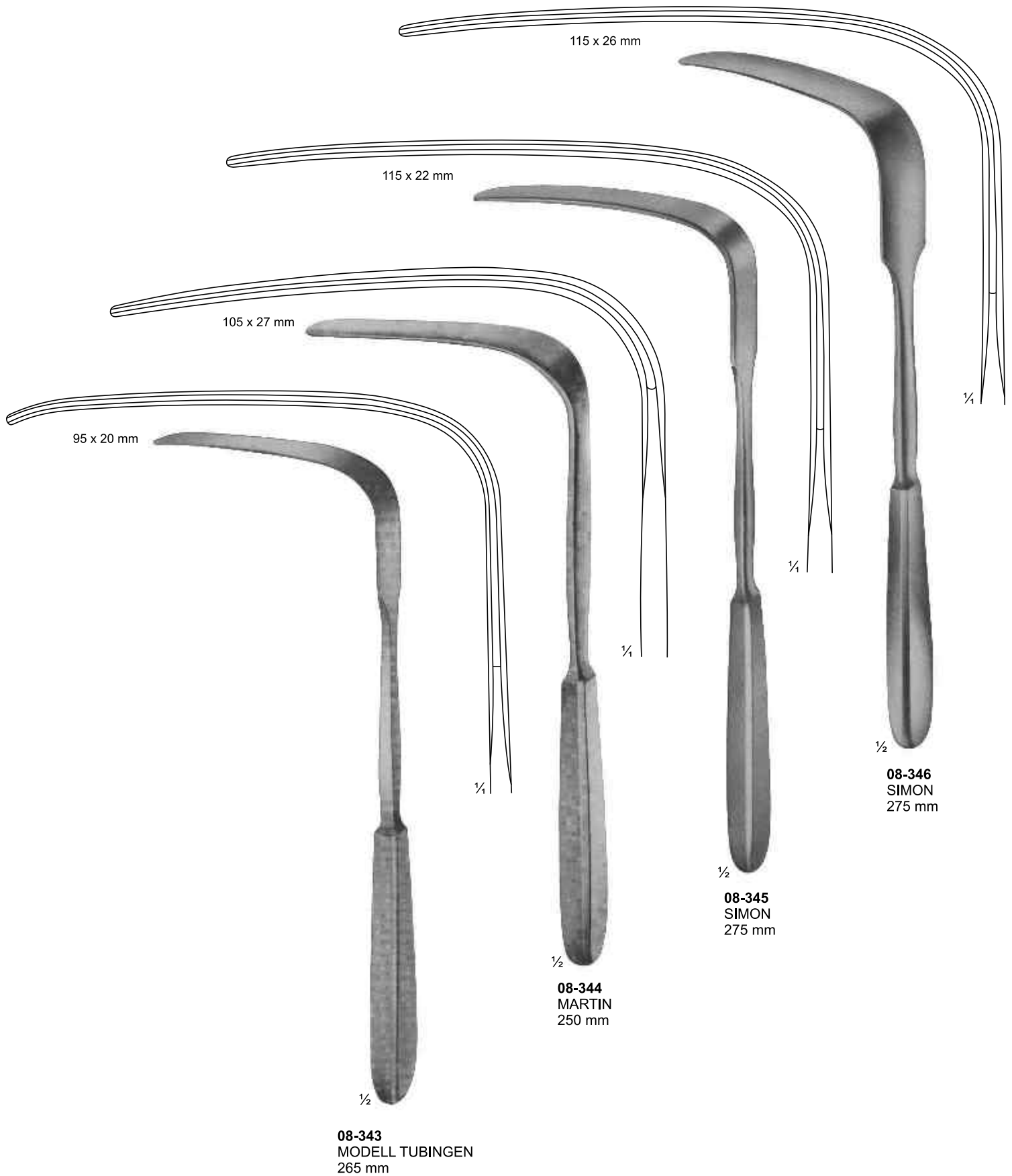



**Vario Retractor System, Germ. Fed. Patent,  
Germ. Fed. Regd.Des.**



- 08-347 - 353**  
BRUNNER  
275 mm
- 08-347** 80 x 20
  - 08-348** 100 x 25
  - 08-349** 120 x 25
  - 08-350** 130 x 30
  - 08-351** 140 x 30
  - 08-352** 160 x 30
  - 08-353** 180 x 30



# Retractors, Lung Spatulas

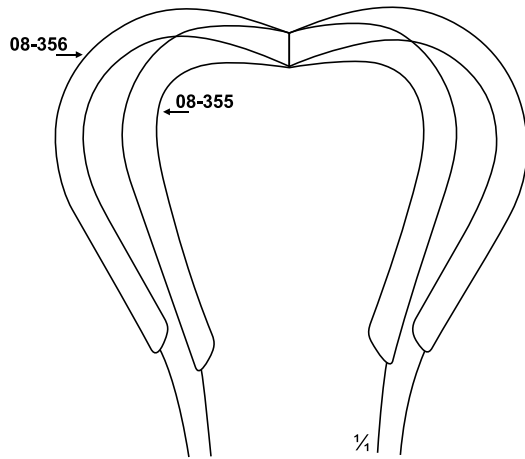

**08-355 - 356**  
**HARRINGTON**  
**08-355** 123 x 45 mm  
**08-356** 123 x 64 mm  
 Flexible  
 295 mm



**08-357**  
**ALLISON**  
 255 mm



**08-358**  
**ALLISON**  
 320 mm



# Retractors, Lung Spatulas



**08-364**  
DEAVER  
300 mm  
Fig. 1

**08-365**  
DEAVER  
315 mm  
Fig. 2

**08-366**  
DEAVER  
365 mm  
Fig. 2

# Retractors, Lung Spatulas



**08-367**  
DEAVER  
300 mm  
Fig. 3

**08-368**  
DEAVER  
310 mm  
Fig. 4

**08-369**  
DEAVER  
320 mm  
Fig. 5

# Retractors, Lung Spatulas

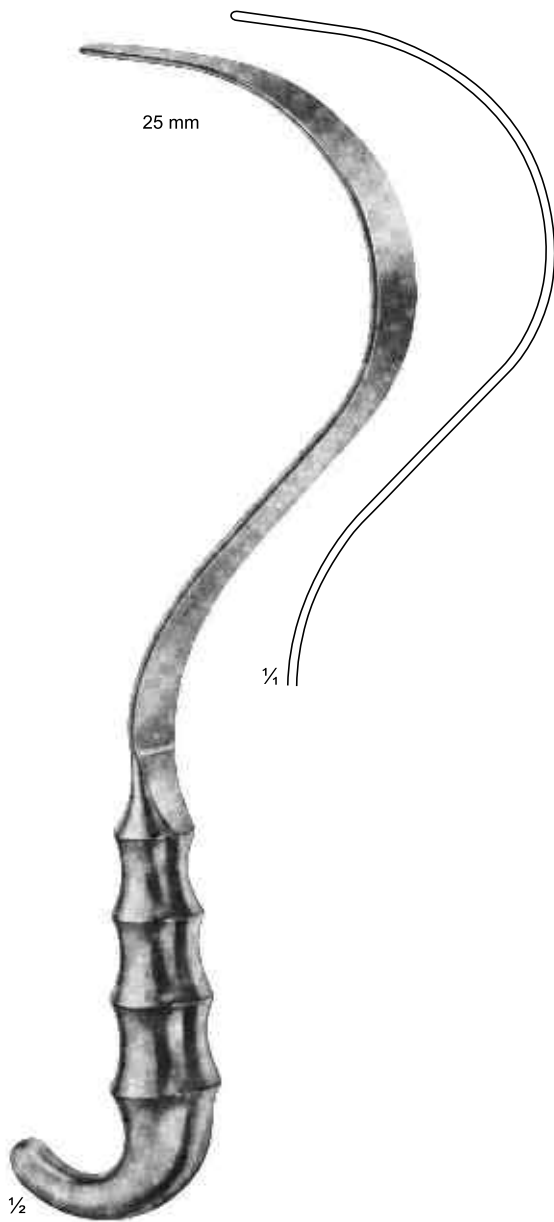

**08-370**  
DEAVER  
310 mm  
Fig. 1

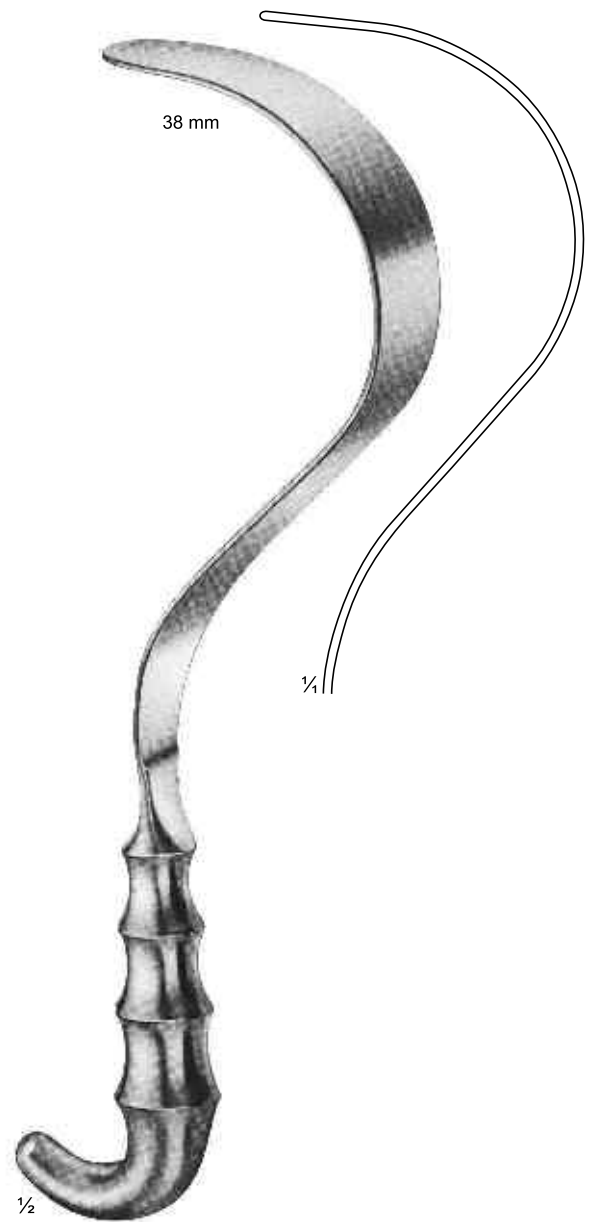

**08-371**  
DEAVER  
310 mm  
Fig. 3

# Retractors, Lung Spatulas

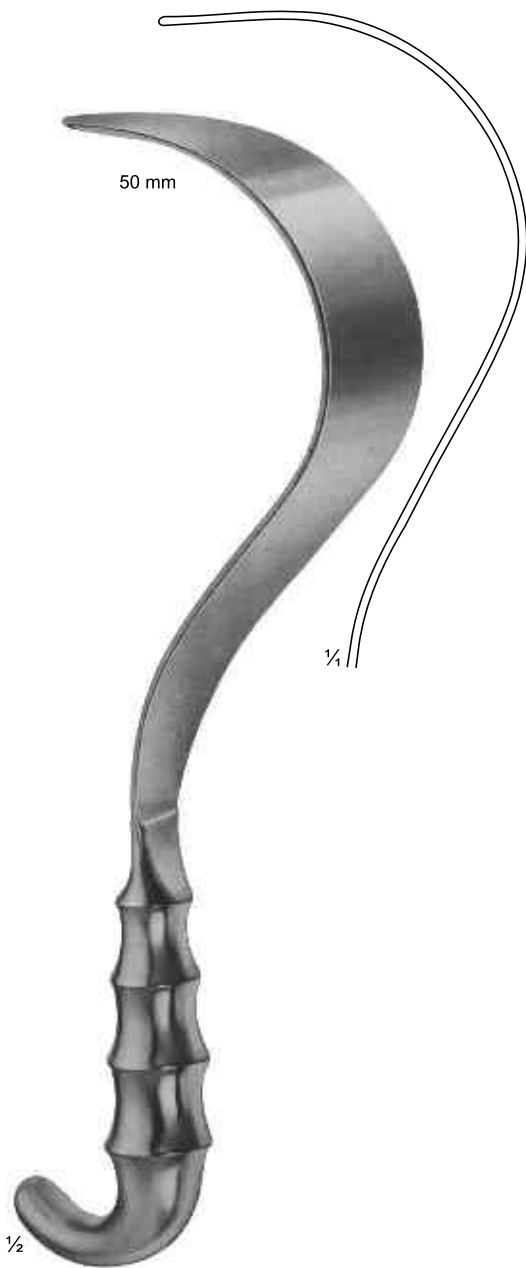

**08-372**  
DEAVER  
305 mm  
Fig. 3



**08-373**  
DEAVER  
310 mm  
Fig. 4

# Retractors For Deep Surgery (Abdominal Retractors)

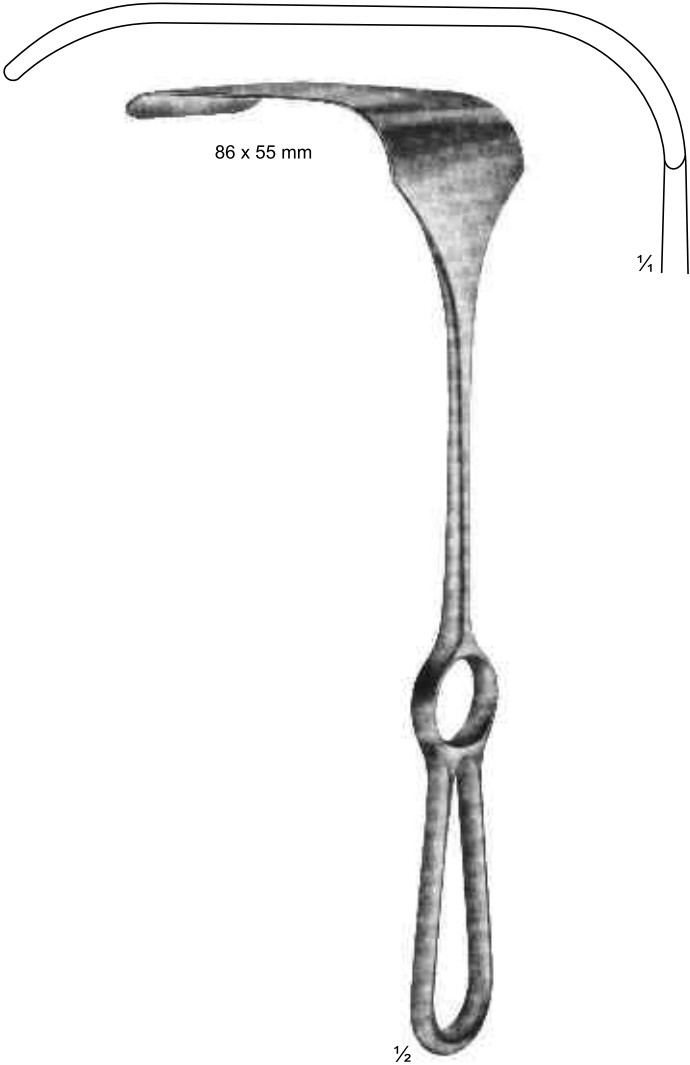

**08-374**  
MIKULICZ  
255 mm

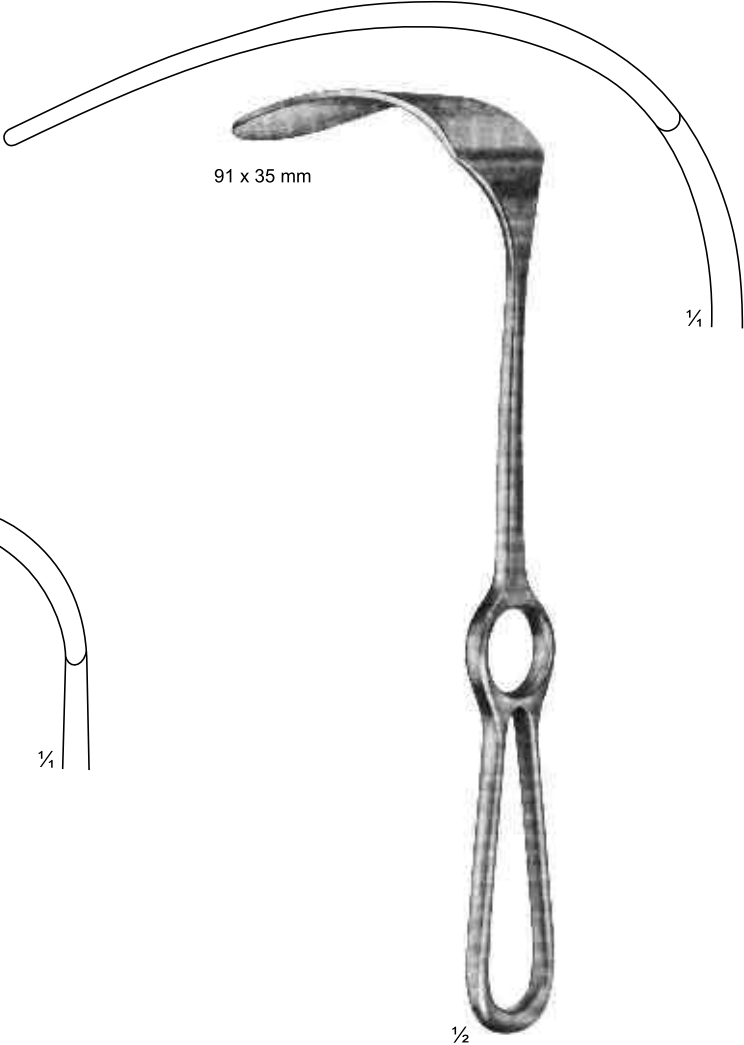

**08-375**  
MIKULICZ  
250 mm



# Retractors For Deep Surgery (Abdominal Retractors)

08-378 150 x 39 mm  
08-379 150 x 57 mm

08-376 121 x 50 mm  
08-377 147 x 50 mm

08-378 - 379  
KELLY  
08-378 150 x 39 mm  
08-379 150 x 57 mm  
260 mm

08-376 - 377  
MIKULICZ  
08-376 121 x 50 mm  
08-377 147 x 50 mm  
Liver Retractor  
250 mm

1/2

1/4

1/2

# Retractors, Abdominal Retractors

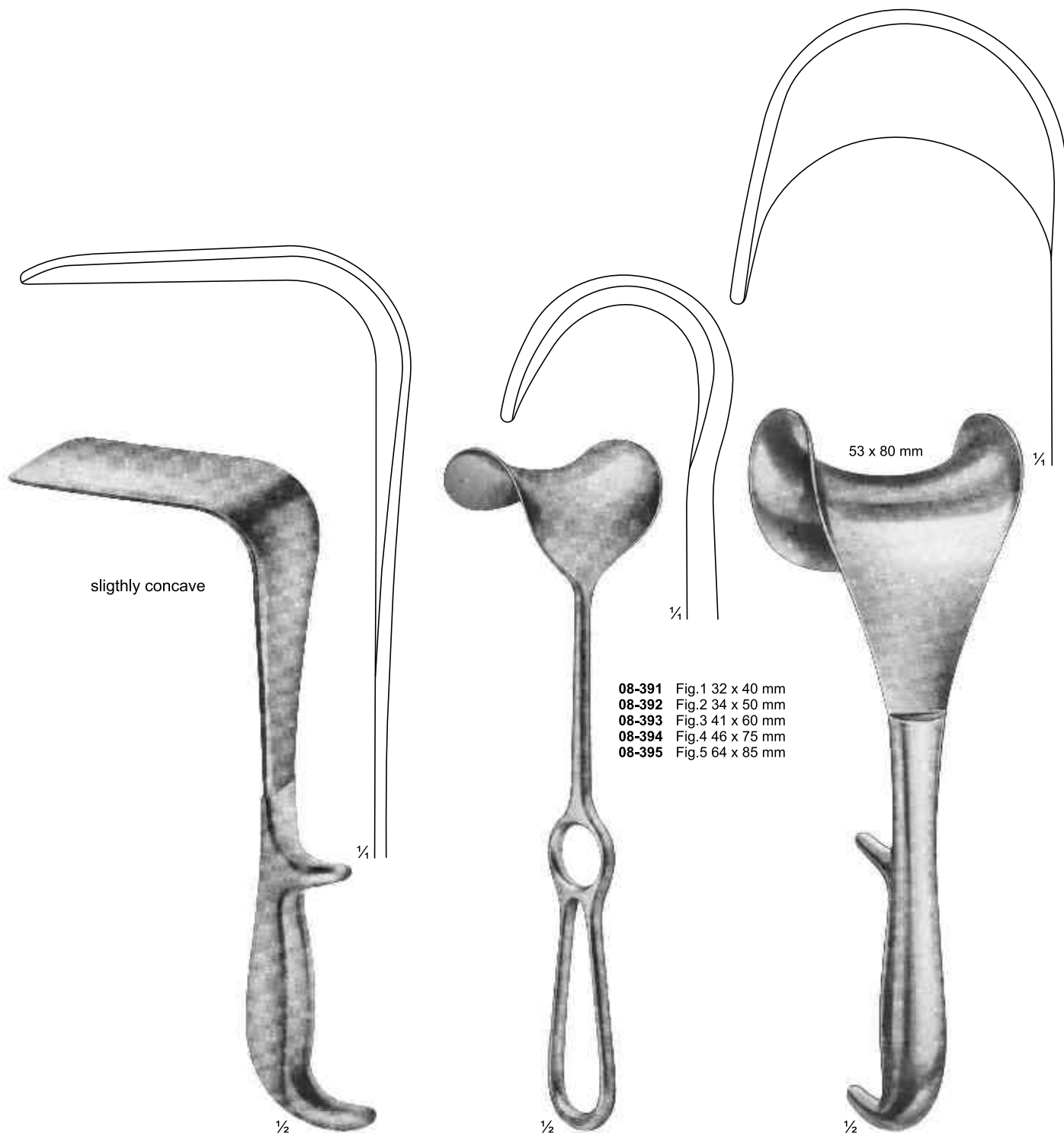

slightly concave

53 x 80 mm

- 08-391 Fig.1 32 x 40 mm
- 08-392 Fig.2 34 x 50 mm
- 08-393 Fig.3 41 x 60 mm
- 08-394 Fig.4 46 x 75 mm
- 08-395 Fig.5 64 x 85 mm

**08-380 - 390**  
DOYEN  
240 mm

**08-391 - 395**  
FRITSCH  
240 mm

**08-396**  
DOYEN  
250 mm

<b>Width of Blades</b>	
35 mm, 45 mm, 60 mm	
<b>Length of Blades</b>	
62 mm	08-380, 08-381, 08-382
92 mm	08-383, 08-384, 08-385
122 mm	08-386, 08-387, 08-388
160 mm	08-389, 08-390

# Abdominal Retractors



**08-397 - 401**  
**ROCHARD**  
 310 mm  
**08-397** 48 x 90 mm  
**08-398** 48 x 105 mm  
**08-399** 48 x 120 mm  
**08-400** 48 x 135 mm  
**08-401** 48 x 155 mm



**08-402**



**08-403 - 406**  
**DOYEN**  
 280 mm  
**08-403** 48 x 90 mm  
**08-404** 48 x 105 mm  
**08-405** 48 x 120 mm  
**08-406** 48 x 135 mm



**08-407**  
**DOYEN-CHILD**  
 Fixation device  
 220 mm



**08-408**  
 Chain with  
 weight (747 / 645g)  
 790 mm

# Pelvis Retractors

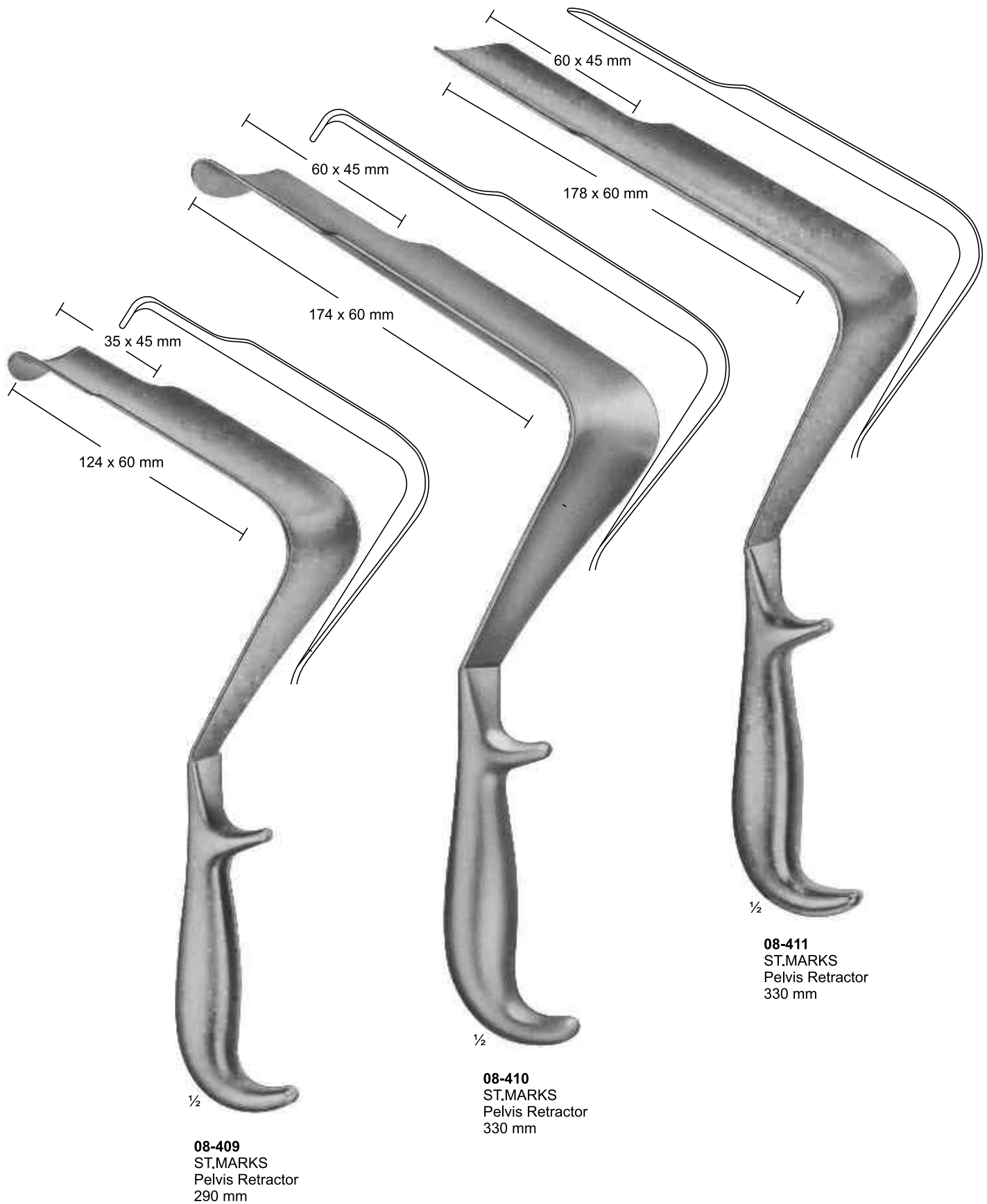

# Abdominal- and Intestinal Spatulas



**08-412**  
LERICHE  
255 mm

**08-413**  
KUMMEL  
Malleable  
285 mm

**08-414**  
MIKULICZ  
29 mm  
250 mm

**08-415 - 416**  
KADER  
**08-415** 30 mm  
**08-416** 40 mm  
270 mm

# Abdominal- and Intestinal Spatulas



**08-417**  
**REVERDIN**  
285 mm



**08-418**  
**HABERER**  
Malleable  
305 mm



**08-419** 30 mm  
**08-420** 40 mm  
**08-421** 50 mm  
Malleable  
330 mm



**08-422**  
**TUFFIER**  
Malleable  
200 mm

# Self-Retaining Retractors



**08-423**  
BOSE  
60 mm



**08-424**  
FINSEN  
50 mm



**08-425**  
FINSEN  
70 mm



**08-426**  
FINSEN modif.  
75 mm



**08-427**  
45 mm



**08-428**  
55 mm



**08-429**  
MUELLER  
65 mm



**08-430**  
100 mm



**08-431**



**08-432**



$\frac{1}{2}$

**08-431 - 432**  
ALM  
**08-431** 70 mm  
**08-432** 100 mm



$\frac{1}{2}$

**08-433**  
LOGAN  
modif. REILL  
50 mm



$\frac{1}{2}$

**08-434**  
JANSSEN  
100 mm



$\frac{1}{2}$

**08-435**  
JANSSEN  
100 mm

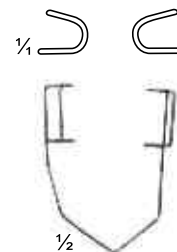

$\frac{1}{2}$

**08-436**  
BARRAQUER  
45 mm

# Self-Retaining Retractors

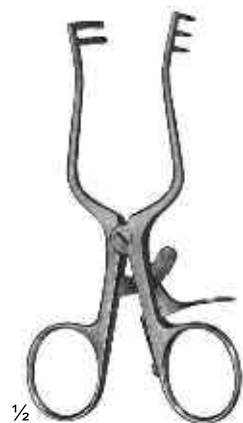

**08-437**  
WEITLANER  
Sharp  
110 mm

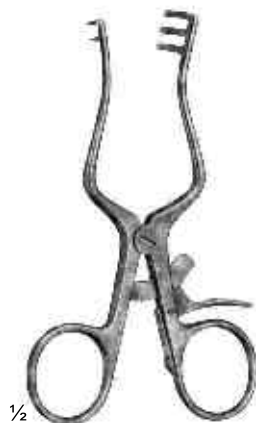

**08-438**  
WEITLANER  
Semi-Sharp  
110 mm



**08-439**  
WEITLANER  
Blunt  
110 mm



**08-440**  
WEITLANER  
Sharp  
130 mm



**08-441**  
WEITLANER  
Semi-Sharp  
130 mm



**08-442**  
WEITLANER  
Blunt  
130 mm



# Self-Retaining Retractors

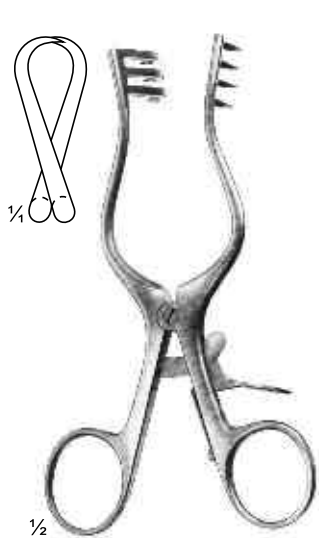

**08-443**  
WEITLANER  
Sharp  
130 mm

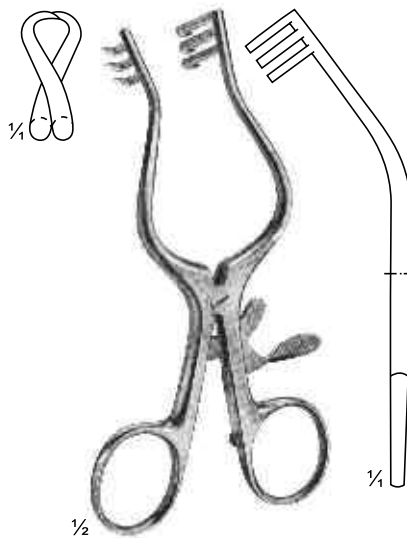

**08-444**  
WULLSTEIN  
Sharp  
130 mm

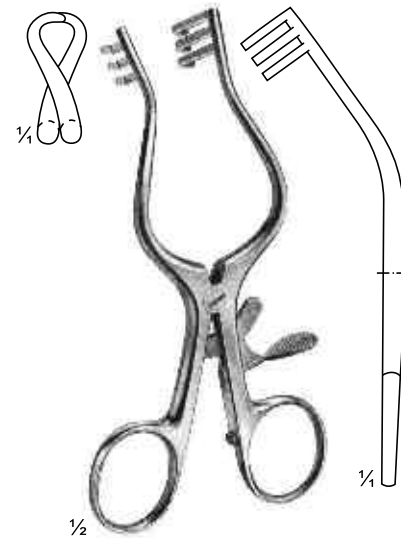

**08-445**  
WULLSTEIN  
Blunt  
130 mm



**08-446**  
WEITLANER  
Sharp  
165 mm



**08-447**  
PLESTER  
Blunt  
110 mm

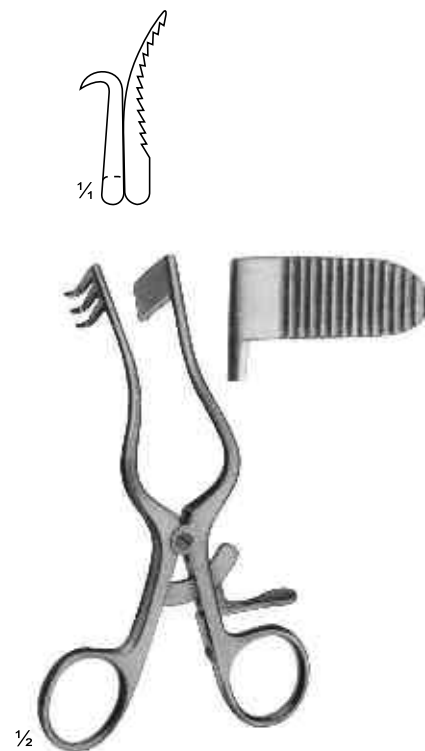

**08-448**  
PERKINS  
Blunt  
130 mm

# Self-Retaining Retractors



**08-449**  
ADSON-BABY  
Blunt  
140 mm

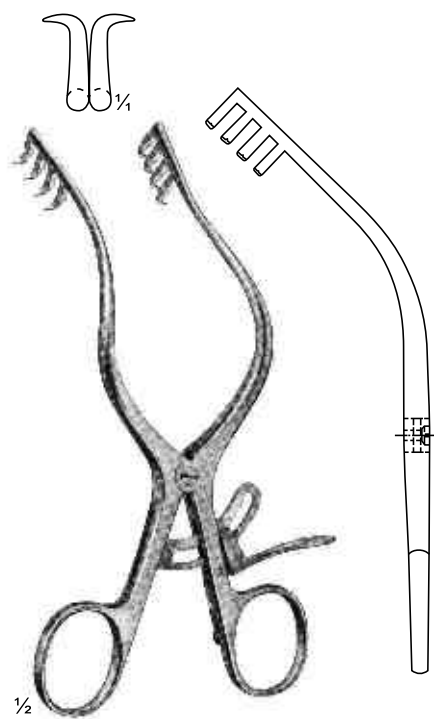

**08-450**  
MOLLISON  
Sharp  
155 mm

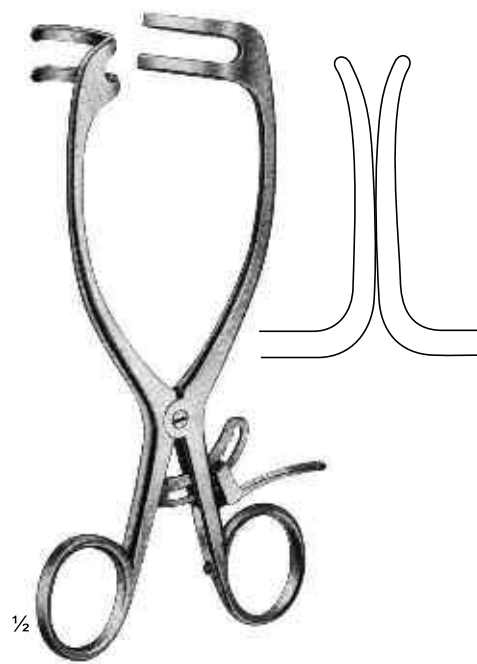

**08-451**  
MAYO-ADAMS  
165 mm

# Self-Retaining Laminectomy Retractors

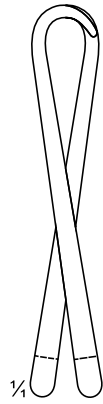
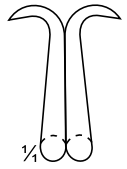

**08-452**  
ANDERSON-ADSON  
Sharp  
190 mm



**08-453**  
NORFOLK and  
NORWICH  
Blunt  
220 mm



**08-454**  
ADSON  
Sharp  
265 mm

# Self-Retaining Laminectomy Retractors

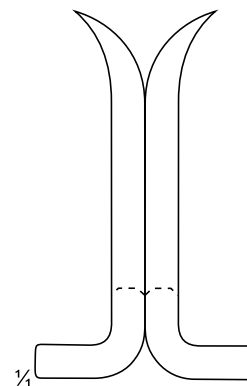
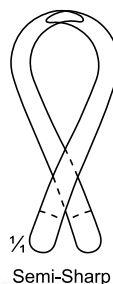
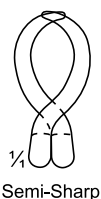
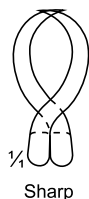

**08-455 - 456**  
BECKMANN-ADSON  
Sharp  
310 mm



**08-456**  
BECKMANN-ADSON  
Semi-Sharp  
310 mm

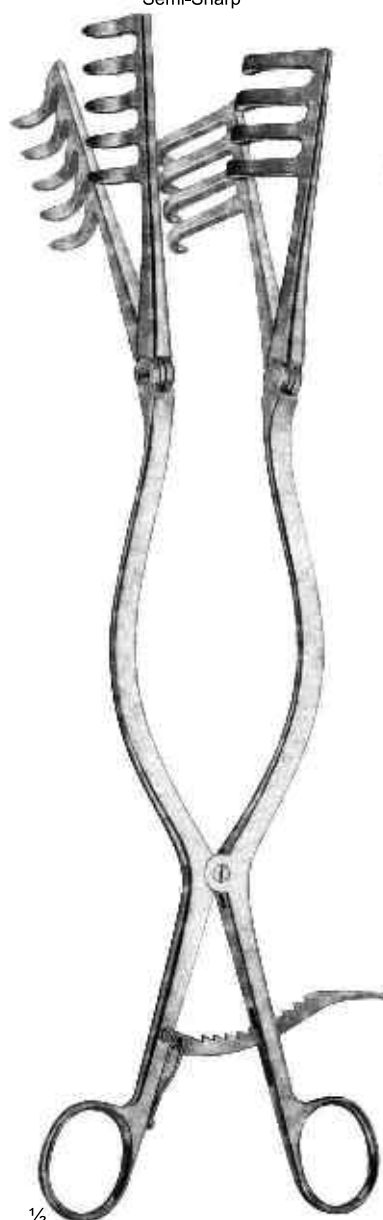

**08-457**  
ADSON  
Semi-Sharp  
320 mm

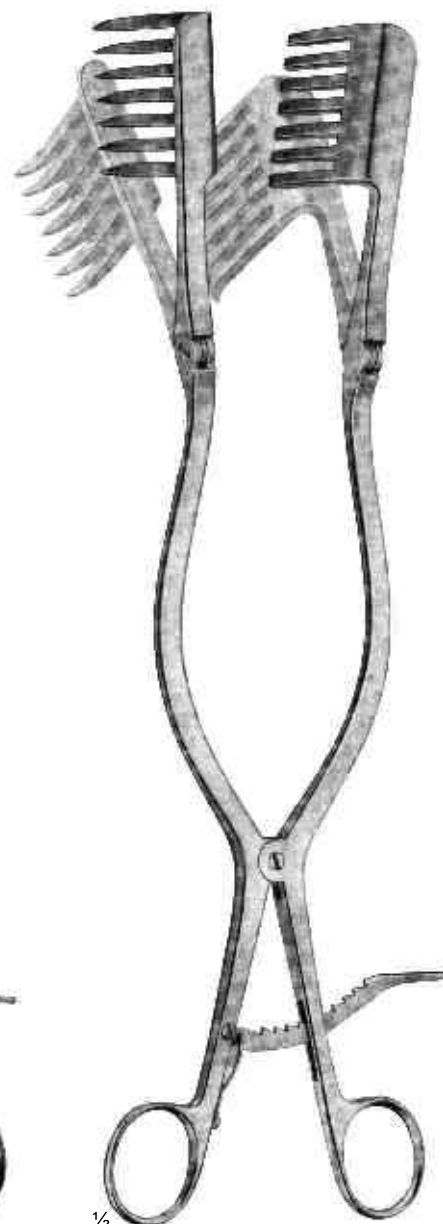

**08-458**  
BECKMANN-EATON  
Sharp  
320 mm

# Special Retractors



**08-459**  
**JOLL ( FRIEDMAN )**  
 Thyroid- and Vaginal Retractor  
 155 mm

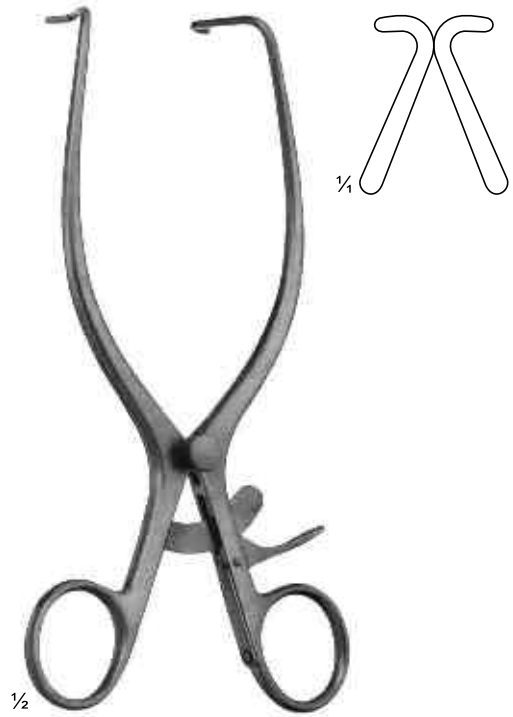

**08-460**  
**JACKSON BURROWS**  
 Retractor, blunt  
 185 mm

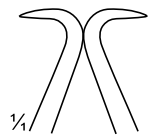

**08-461**  
**GELPI**  
 Vaginal Retractor  
 135 mm

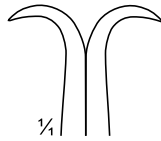

**08-462**  
**GELPI**  
 Skin- and Vaginal Retractor  
 175 mm

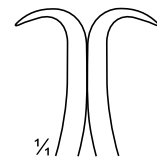

**08-463**  
**DE BAKEY**  
 Femur Retractor  
 145 mm

# Self Retaining Retractors for Laminectomy and other Operations

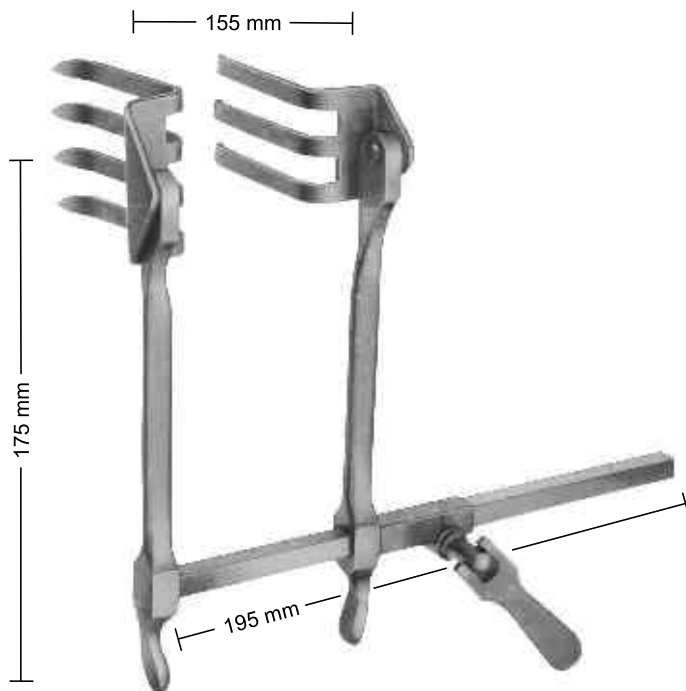

**08-464 - 468**  
**SCOVILLE-RICHTER**  
 Retractor with 1 pair  
 blades reversible type.  
 The Retractor bar and  
 shanks may be easily  
 rotated 180° when  
 blades are in situ.



**08-465**  
 62 x 52 mm    62 x 37 mm  
 PR= Pair



**08-466**  
 47 x 51 mm



**08-467**  
 30 x 40 mm



**08-468**  
 37 x 62 mm

# Retractors for Cervical Spine



**08-469**  
CLOWARD modif.  
Spreader Only



16 mm  
**08-470**



16 mm  
**08-471**



16 mm  
**08-475**



16 mm  
**08-476**

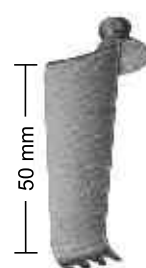

16 mm  
**08-472**

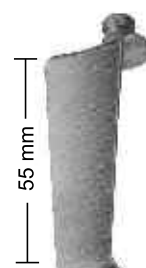

16 mm  
**08-473**

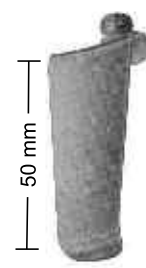

16 mm  
**08-477**

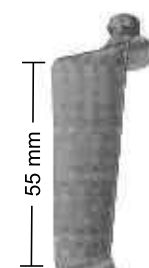

16 mm  
**08-478**

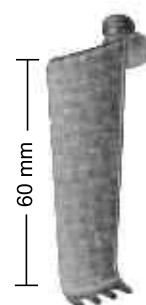

16 mm  
**08-474**

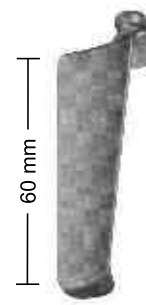

16 mm  
**08-479**

08-470 blade  
08-471 blade  
08-472 blade  
08-473 blade  
08-474 blade

08-475 blade  
08-476 blade  
08-477 blade  
08-478 blade  
08-479 blade

# Retractors for Cervical Vertebral Column

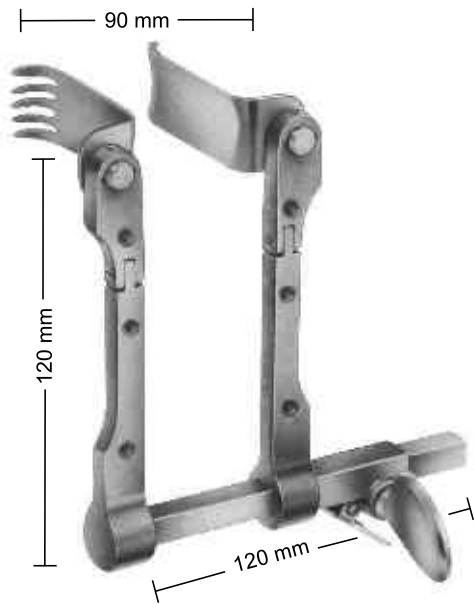

**08-480**  
CASPAR  
Retractor, adjustable,  
consisting of: 5 medial  
blades, 5 Lateral blades.

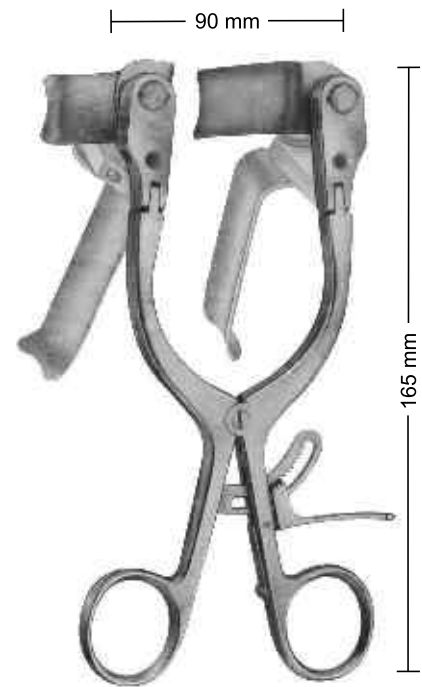

**08-480 A**  
CASPAR  
Counter retractor, adjustable,  
consisting of: 5 blades.



**08-481** 40 x 23 mm  
**08-482** 45 x 23 mm  
**08-483** 50 x 23 mm  
**08-484** 55 x 23 mm  
**08-485** 60 x 23 mm  
Medial blades

**08-486** 40 x 23 mm  
**08-487** 45 x 23 mm  
**08-488** 50 x 23 mm  
**08-489** 55 x 23 mm  
**08-490** 60 x 23 mm  
Lateral blades

**08-491** 45 x 23 mm  
**08-492** 50 x 23 mm  
**08-493** 55 x 23 mm  
**08-494** 60 x 23 mm  
**08-495** 65 x 23 mm  
Blunt blades

**08-496** 50 x 25 mm  
**08-497** 60 x 25 mm  
Blunt blades,  
for harvesting of the  
fusion graft from the  
iliac crest

**08-498** 40 x 25 mm  
**08-499** 45 x 25 mm  
**08-500** 50 x 25 mm  
**08-501** 55 x 25 mm  
**08-502** 60 x 25 mm  
Medial Titan blades  
semi transparent to x-ray

**08-503** 40 x 25 mm  
**08-504** 45 x 25 mm  
**08-505** 50 x 25 mm  
**08-506** 55 x 25 mm  
**08-507** 60 x 25 mm  
Lateral Titan blades  
semi transparent to x-ray



# Lamina Spreaders



**08-508**  
CLOWARD  
155 mm

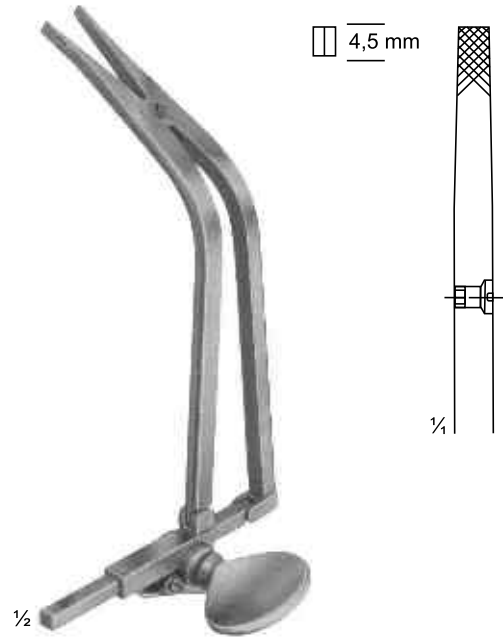

**08-509**  
CLOWARD  
135 mm

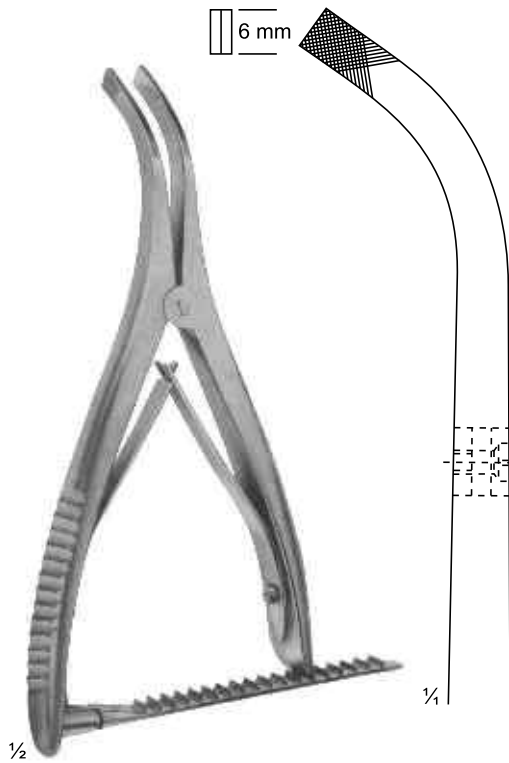

**08-510**  
INGE  
170 mm

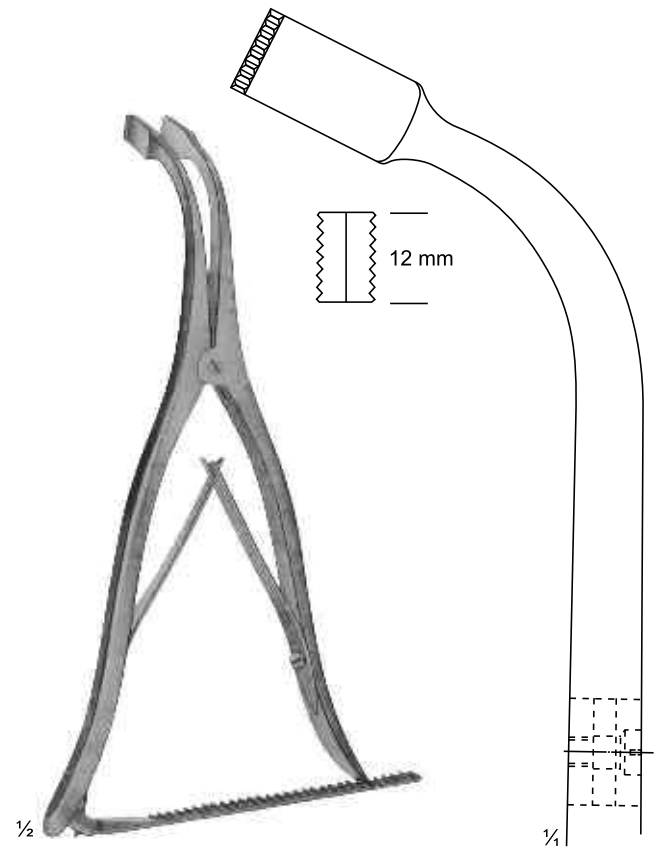

**08-511**  
INGE  
275 mm

# Abdominal Retractors



**08-512**  
BABY-COLLIN  
with 2 pair of blades

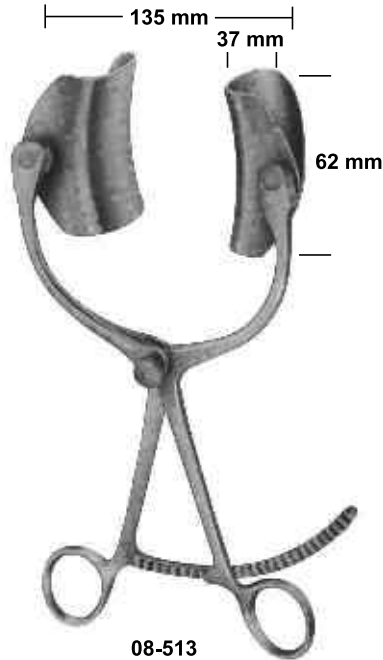

**08-513**  
COLLIN  
complete

08-817 135 mm  
08-818 160 mm

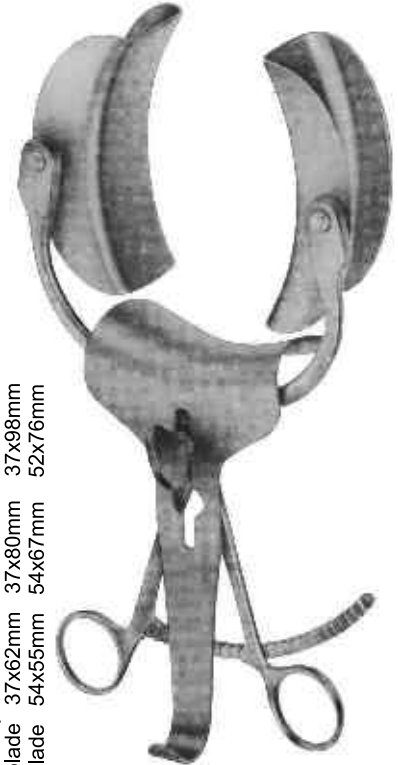

08-516  
08-515  
08-514  
08-514  
08-514  
08-514

**08-514 - 518**  
COLLIN  
complete

210 mm



**08-519 - 520**  
RICARD  
complete

Spreader only **08-519** **08-520**  
Lateral blade 58x80mm 72x84mm  
Canter blade 54x70mm 72x90mm

275 mm



**08-521 - 523**  
HOLZBACH  
Complete

**08-521** Spreader only  
**08-522** Lateral blade 59x80mm  
**08-523** Canter blade 74x82mm

# Abdominal Baldes

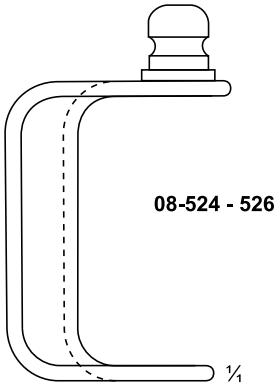

Lateral blades only  
**08-524** 37x62 mm  
**08-525** 37x80 mm  
**08-526** 37x98 mm

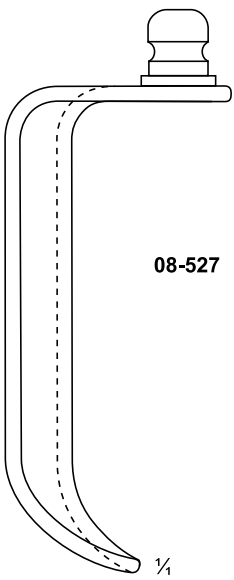

**08-527** 61x80 mm

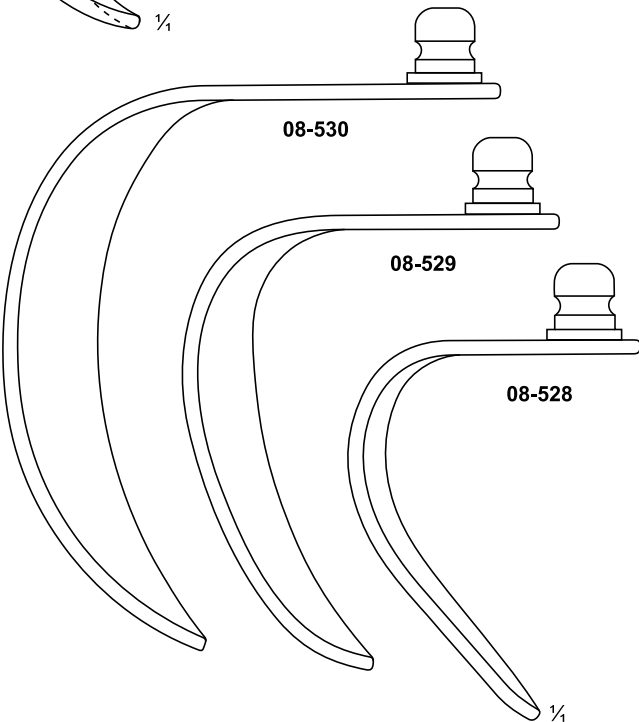

**08-528** 48x59 mm  
**08-529** 58x80 mm  
**08-530** 72x84 mm

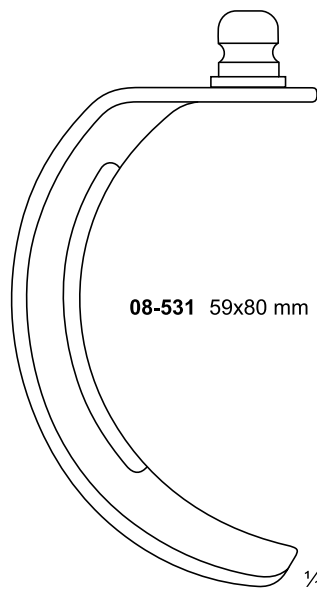

**08-531** 59x80 mm



# Abdominal Retractors

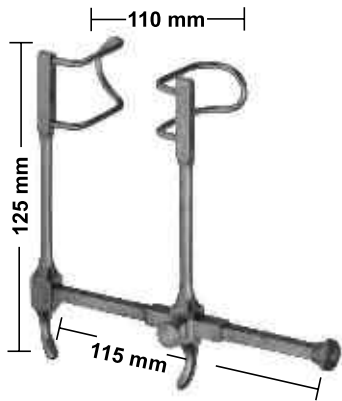

**08-532**  
GOSSET  
Blades:38 mm deep

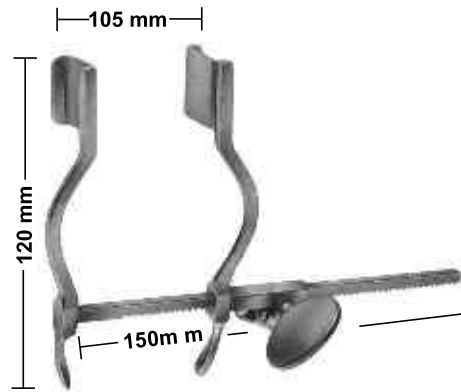

**08-533**  
HERTZLER  
Blades 20 X 25 mm

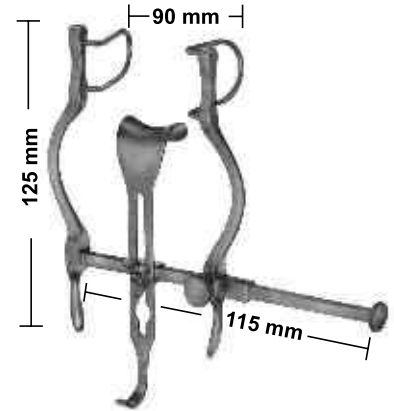

**08-534**  
BALFOUR-BABY  
Lateral blades 27 mm deep  
Center blade 21x24 mm

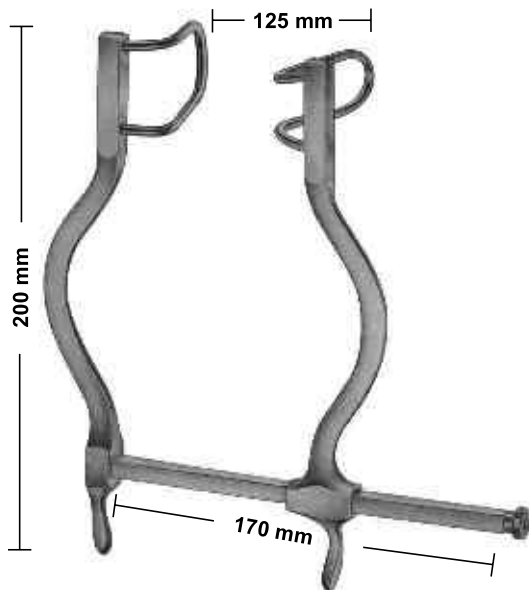

**08-535**  
GOSSET  
Blades:55mm deep

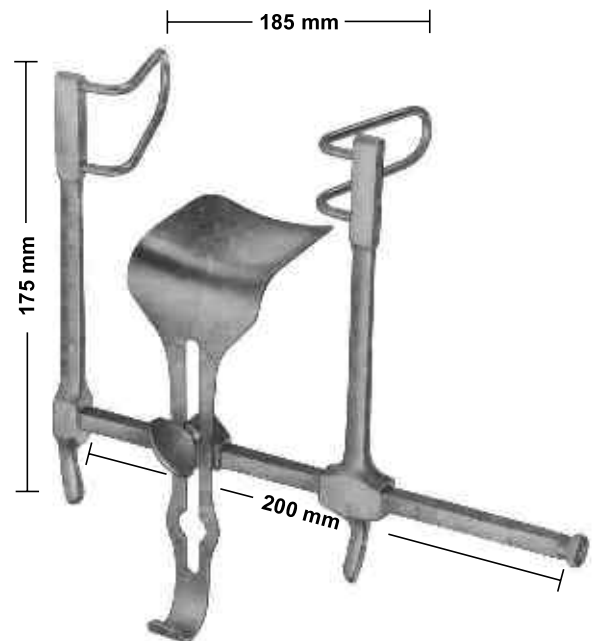

**08-536**  
GOSSET  
Lateral blades 58 mm deep  
Center blade 59 x 57 mm

# Abdominal Retractors

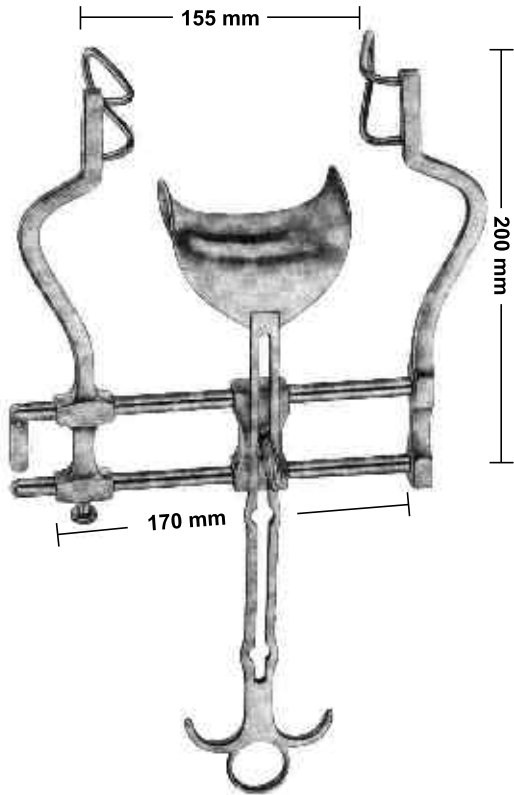

**08-537**  
BALFOUR  
Lateral blades 60 mm deep  
Center blade 47 x 80 mm

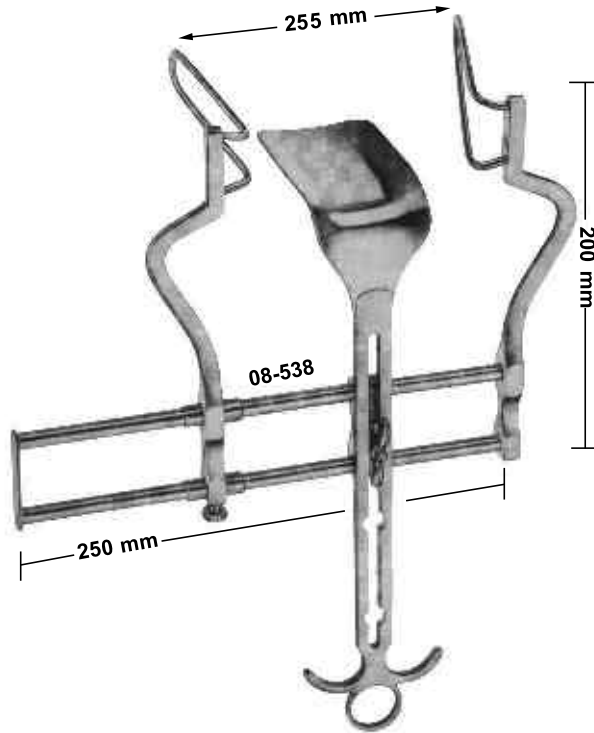

**08-538**  
BALFOUR  
Lateral blades 105 mm deep  
Center blade 107x 59 mm

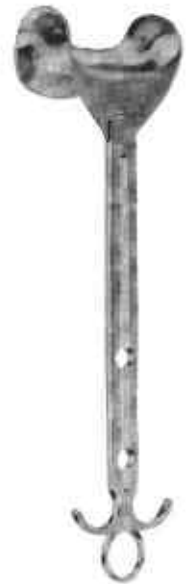

**08-539**  
Center blade only  
54x80 mm

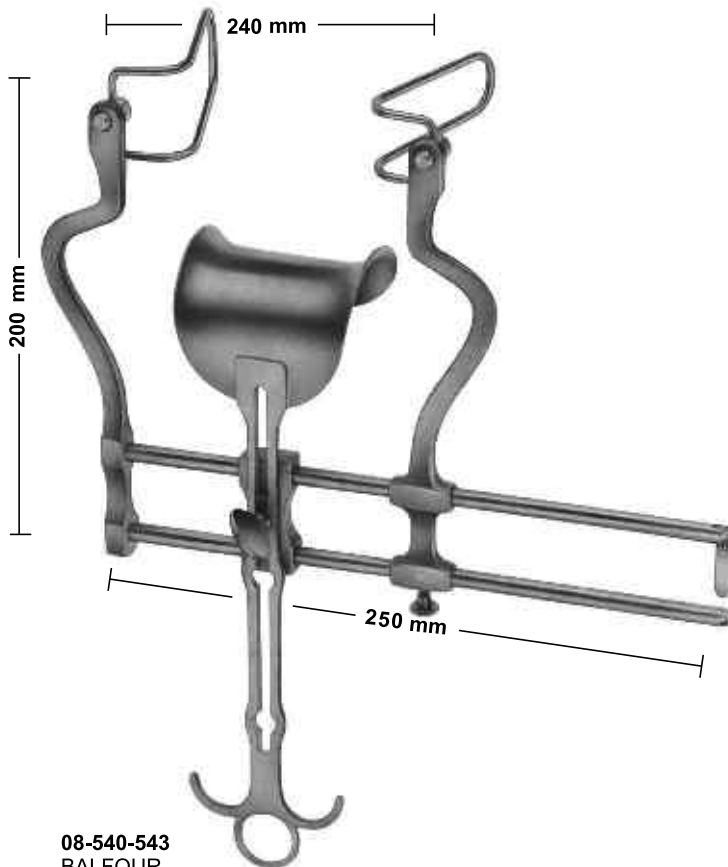

**08-540-543**  
BALFOUR  
Spreader only  
Lateral blades  
Center blade

<b>08-540</b>	<b>08-541</b>	<b>08-542</b>	<b>08-543</b>
50 mm	60 mm	75 mm	90 mm
47 x 80 mm	62x76 mm	80x80 mm	80x80 mm



Sales Unit of blades:PR = pair

Lateral blades  
**08-544** 50 mm deep  
**08-545** 60 mm deep  
**08-546** 75 mm deep  
**08-547** 90 mm deep

# Abdominal Retractors

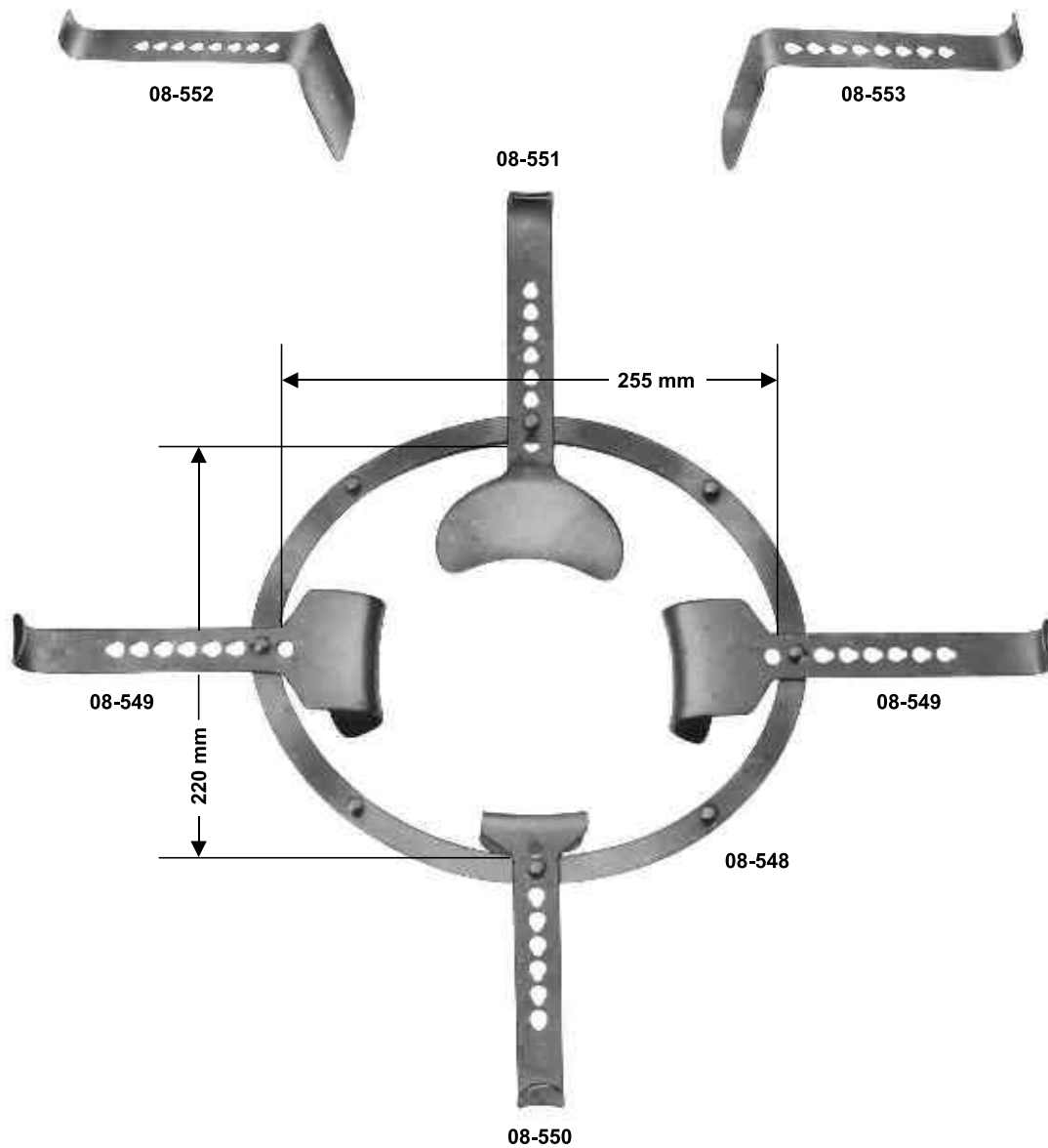

## 08-548 - 08-553

SEMM

consisting of:

- 08-548 1 frame 225 x 220 mm
- 08-549 2 blades 46 x 64 mm
- 08-550 1 blade 53 x 54 mm  
(for bladder)
- 08-551 1 blade 82 x 97 mm  
(for intestine)
- 08-552 1 blade 98 x 51 mm  
(for intestine)
- 08-553 1 blade, narrow  
107 x 36 mm

# Abdominal Retractors

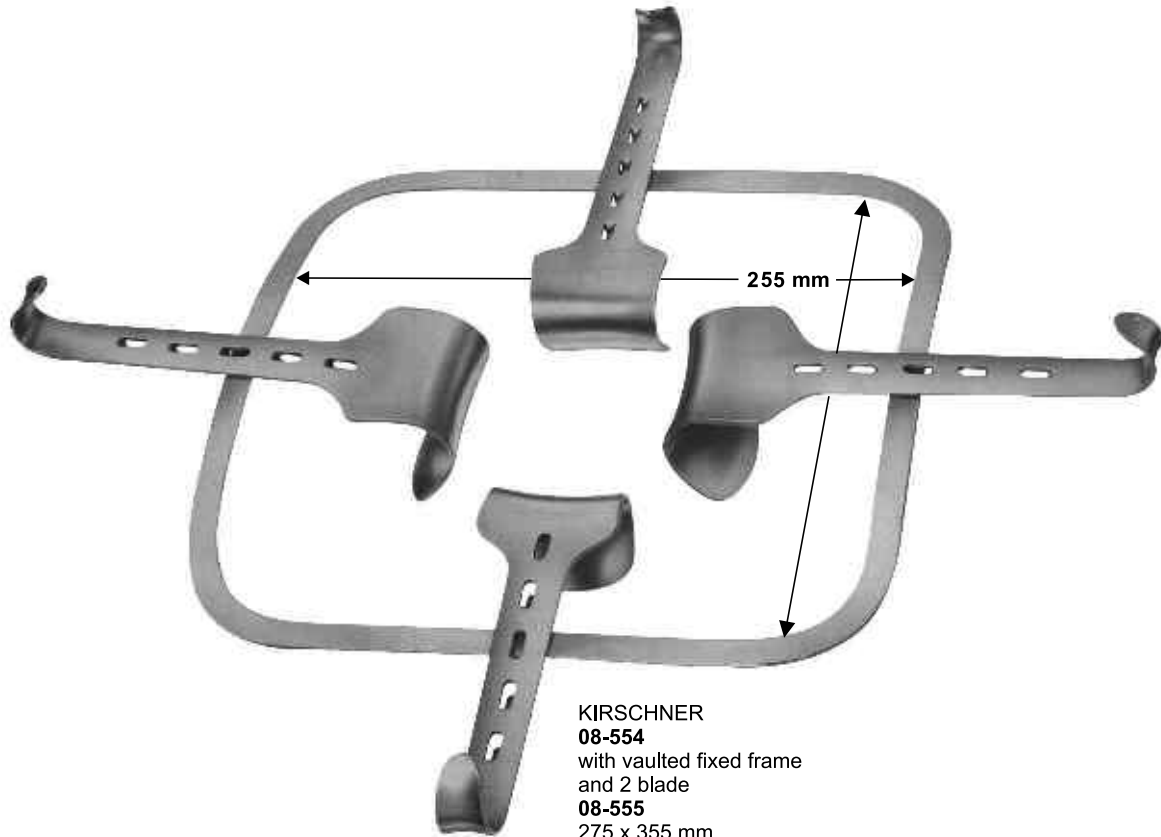

**KIRSCHNER**  
**08-554**  
 with vaulted fixed frame  
 and 2 blade  
**08-555**  
 275 x 355 mm  
 Frame only, over-sized  
**08-556**  
 295 x 275 mm  
 Frame only



**08-557**  
**KIRSCHNER**  
 64 x 80 mm



**08-558**  
**KIRSCHNER-BALFOUR**  
 80x 82 mm



**08-559 - 561**  
**KIRSCHNER**  
**08-559** 90x 69mm  
**08-560** 92x 95mm  
**08-561** 78x 58mm



**08-562 - 564**  
**KIRSCHNER**  
**08-562** 108x42mm  
**08-563** 91x 55mm  
**08-564** 121x 55mm

# Intestinal and Tissue Grasping Forceps

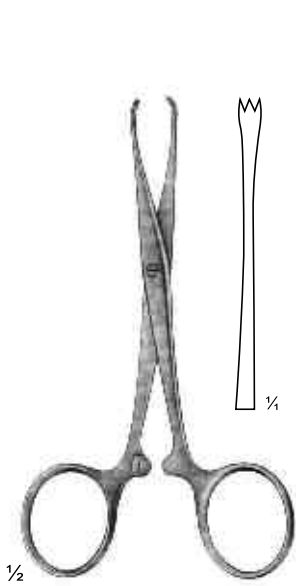

**09-101**  
**CHAPUT**  
 2 X 3 teeth, sharp  
 125 mm,

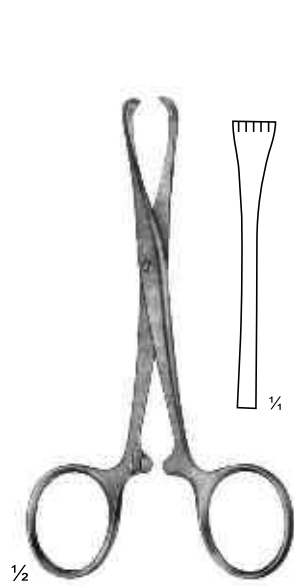

**09-102**  
**TUFFIER**  
 5 X 6 teeth, sharp  
 125 mm,

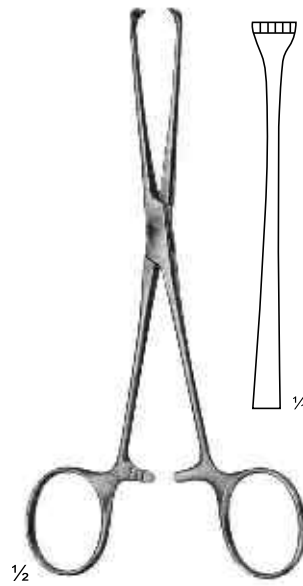

**09-103**  
**BOYS-ALLIS**  
 5 X 6 teeth, sharp  
 155 mm,

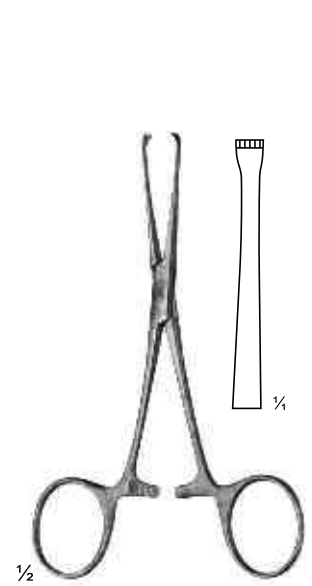

**09-104**  
**ALLIS**  
 4 X 5 teeth  
 155 mm,

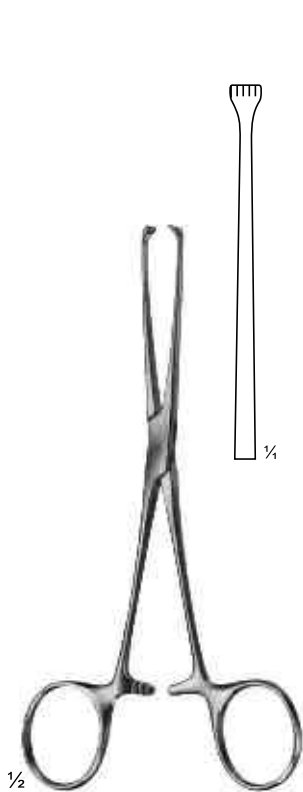

**09-105**  
**ALLIS**  
 155 mm,  
 4 X 5 teeth

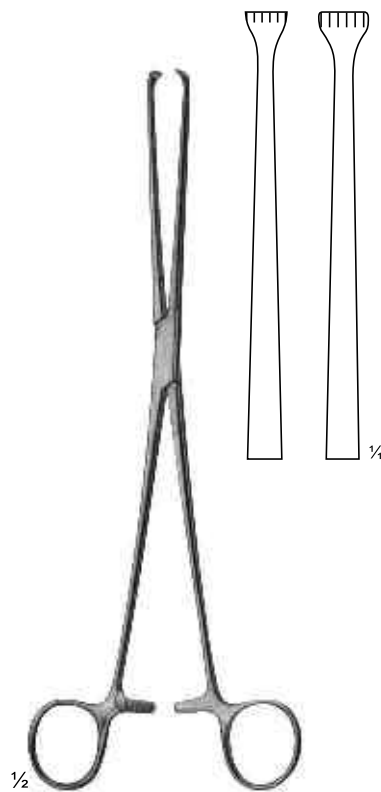

**09-106**  
**ALLIS**  
 190 mm,  
**09-107**  
 255 mm,  
 5 X 6 teeth

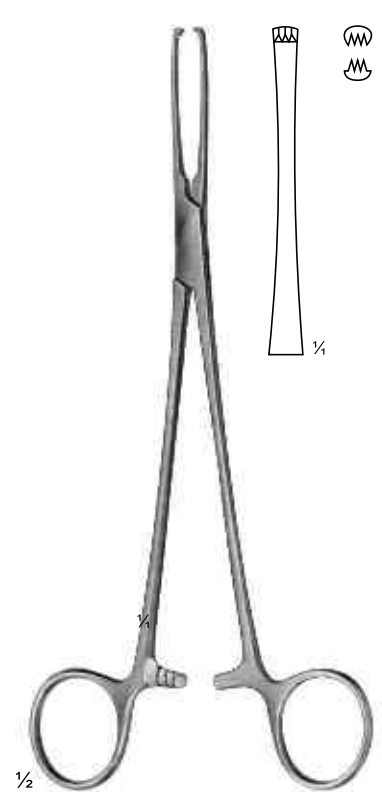

**09-108**  
**JUDD-ALLIS**  
 3 X 4 teeth  
 195 mm,



# Intestinal Grasping Forceps

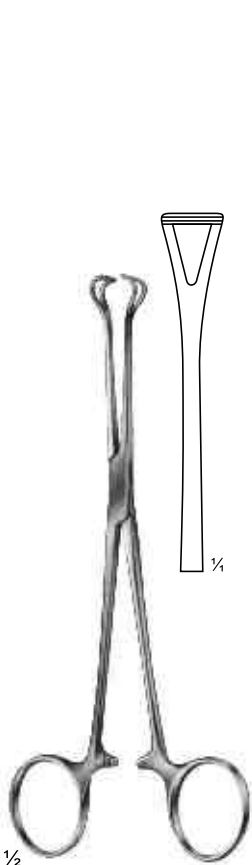

**09-109**  
BABCOCK  
155 mm

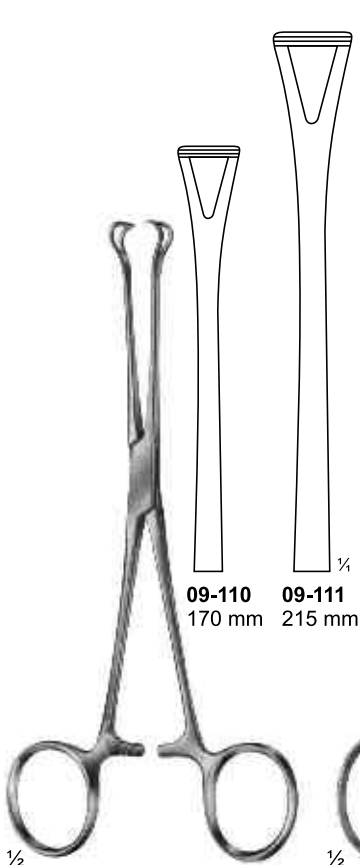

**09-110** 170 mm  
**09-111** 215 mm

**09-110 - 111**  
BABCOCK

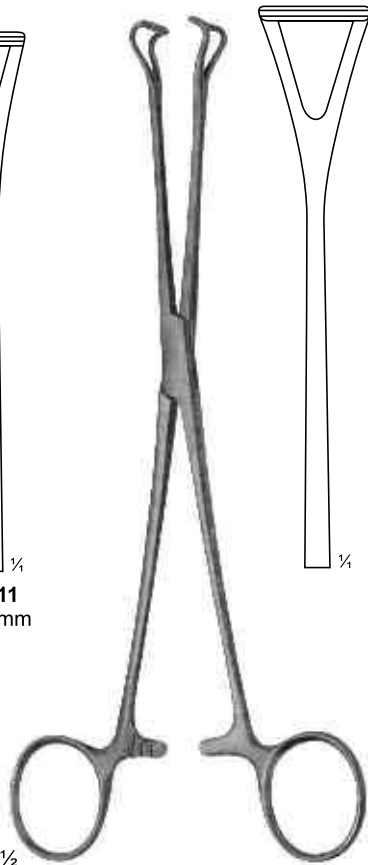

**09-112**  
BABCOCK  
220 mm

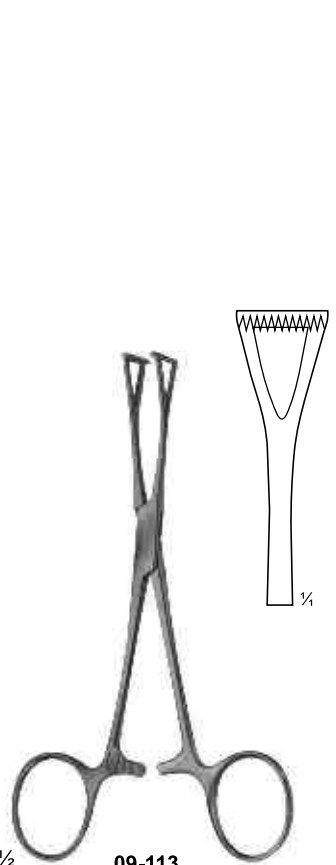

**09-113**  
COLLIN  
140 mm,

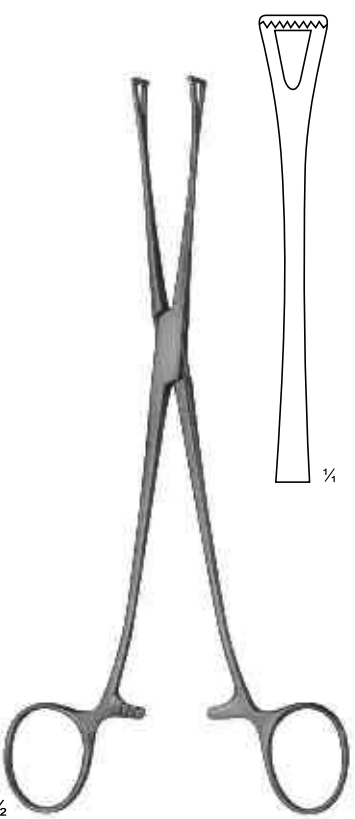

**09-114**  
LOCKWOOD  
200 mm,

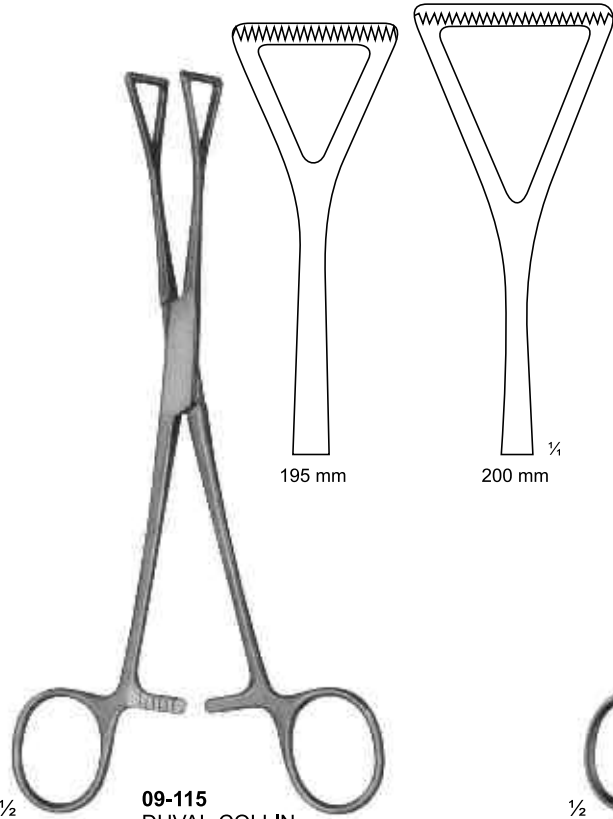

**09-115** 195 mm  
**09-116** 200 mm

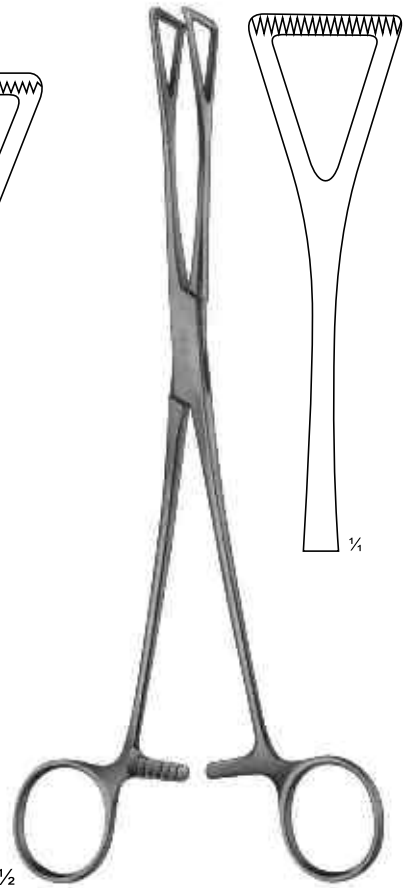

**09-117**  
DUVAL  
230 mm,

# Organ - Tissue Grasping, Dissecting & Intestinal Forceps

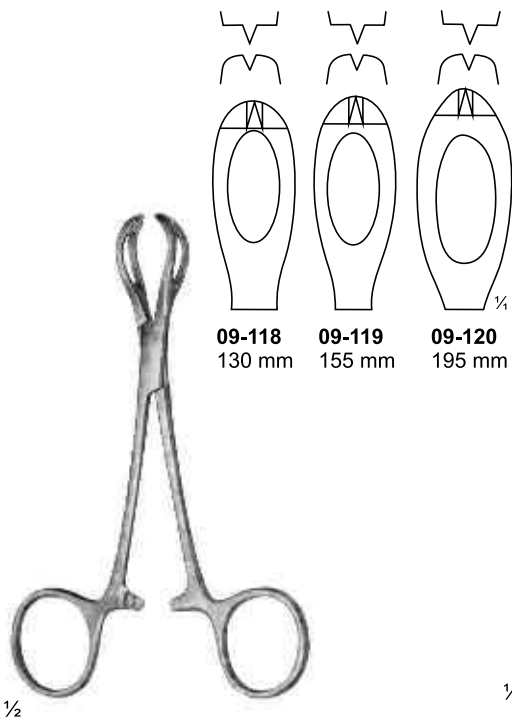

**09-118-120**  
LANE

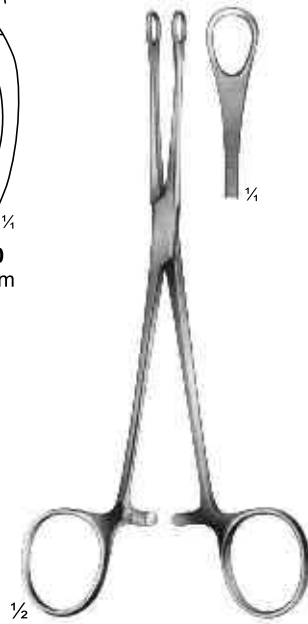

**09-121**  
WILLIAMS  
160 mm



**09-122**  
DENIS  
BROWNE  
190 mm



**09-123**  
DUVAL  
140 mm



**09-124**  
WANGENSTEEN  
150 mm  
**09-125**  
230 mm



**09-126**  
WANGENSTEEN  
150 mm  
**09-127**  
230 mm

# Organ - Tissue Grasping, Dissecting & Intestinal Forceps

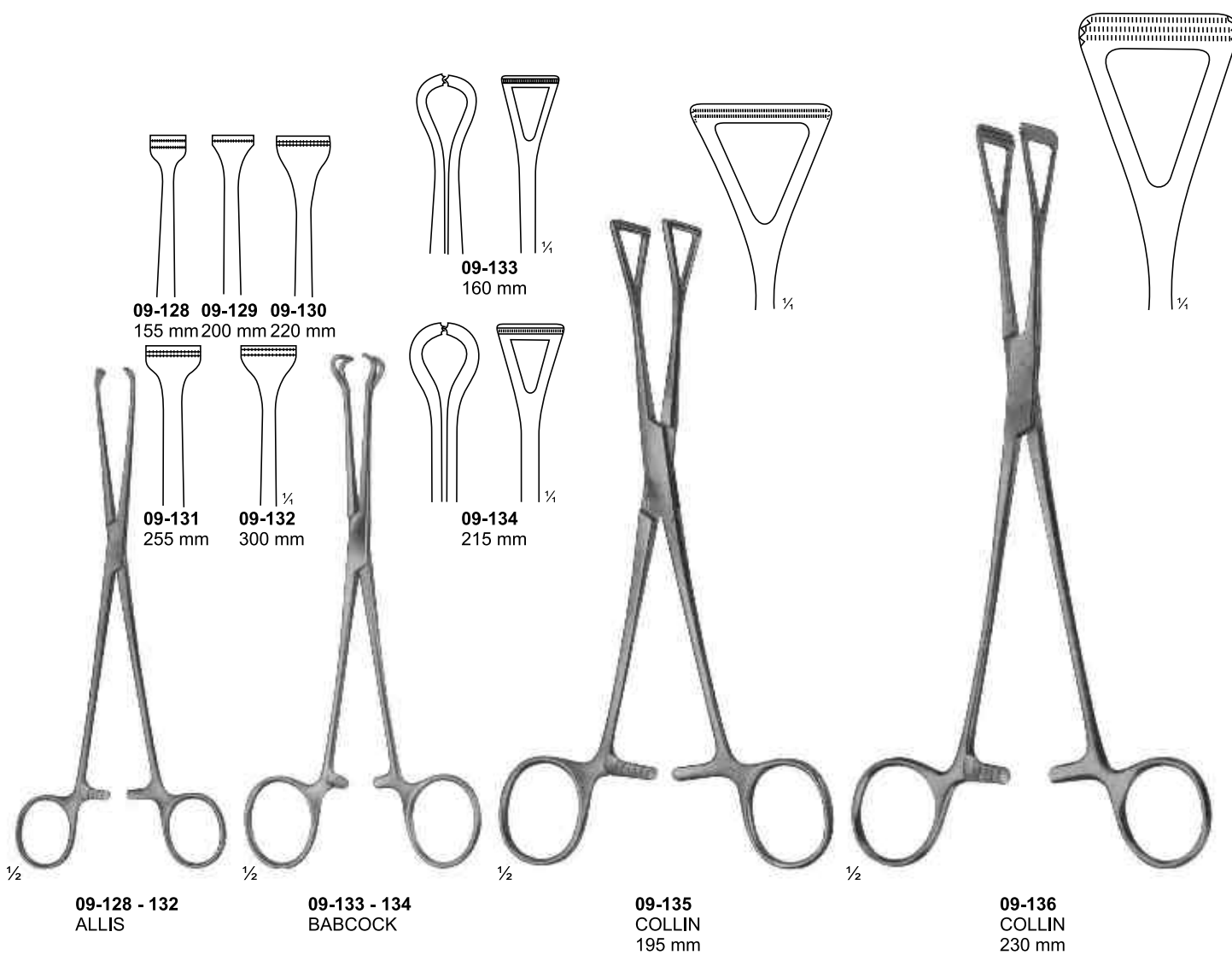

# Ultra - Light - Forceps, Dissecting Forceps

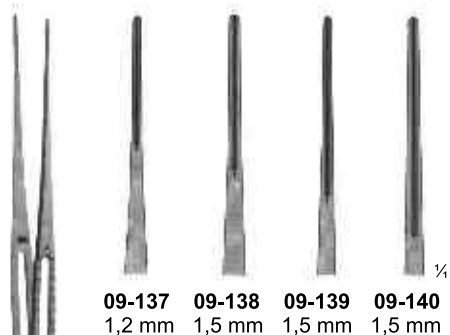

1/2  
**09-137** 150 mm  
**09-138** 200 mm  
**09-139** 240 mm  
**09-140** 300 mm

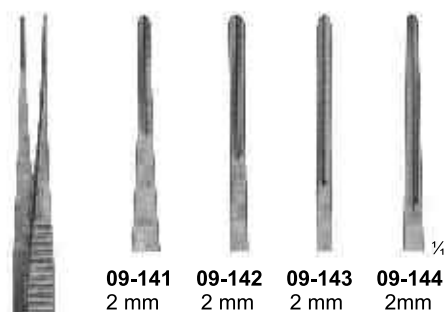

1/2  
**DE BAKEY**  
**09-141** 150 mm  
**09-142** 200 mm  
**09-143** 240 mm  
**09-144** 300 mm

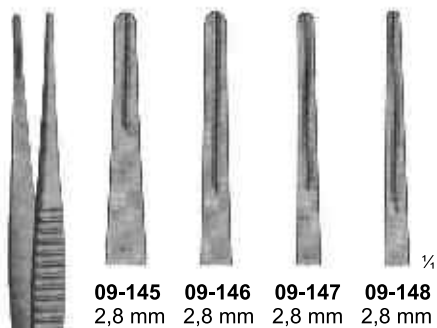

1/2  
**DE BAKEY**  
**09-145** 150 mm  
**09-146** 200 mm  
**09-147** 240 mm  
**09-148** 300 mm

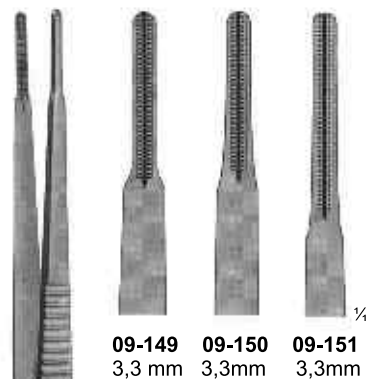

1/2  
**DE BAKEY**  
**09-149** 200 mm  
**09-150** 240 mm  
**09-151** 300 mm

# Intestinal Clamps for Children

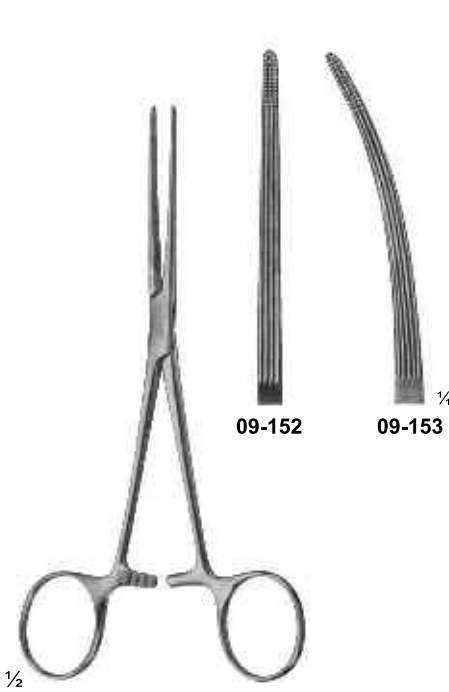

**09-152 - 153**  
BAINBRIDGE  
155 mm



**09-154**  
ALLEN  
155 mm

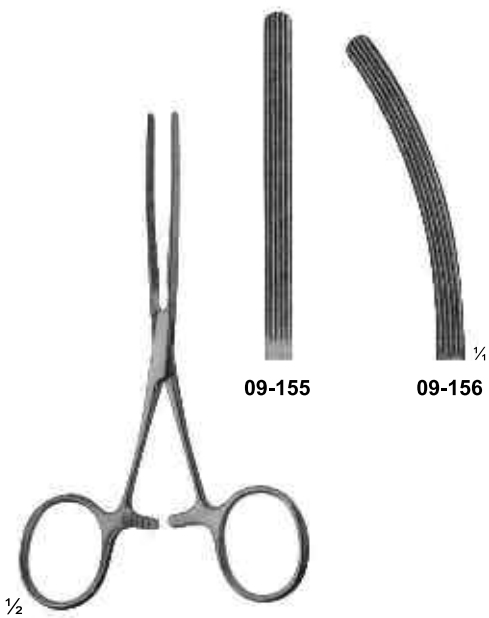

**09-155 - 156**  
BABY-KOCHER  
very elastic blades  
130 mm

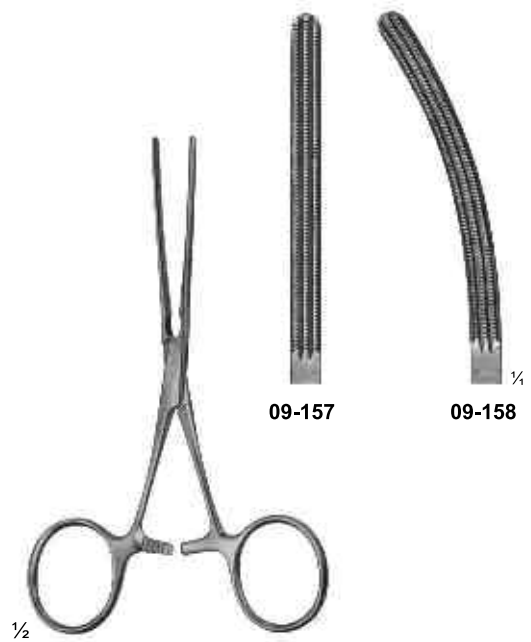

**09-157 - 158**  
BABY-KOCHER  
with elastic blades  
130 mm

# Intestinal Clamps, Soft Elastic

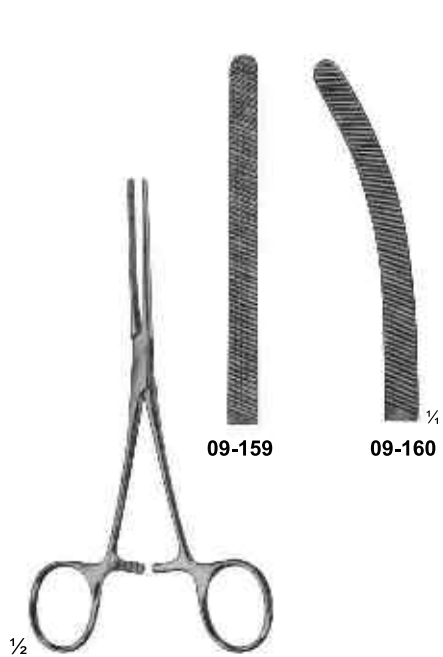

**09-159 - 160**  
DOYEN  
elastic  
165 mm

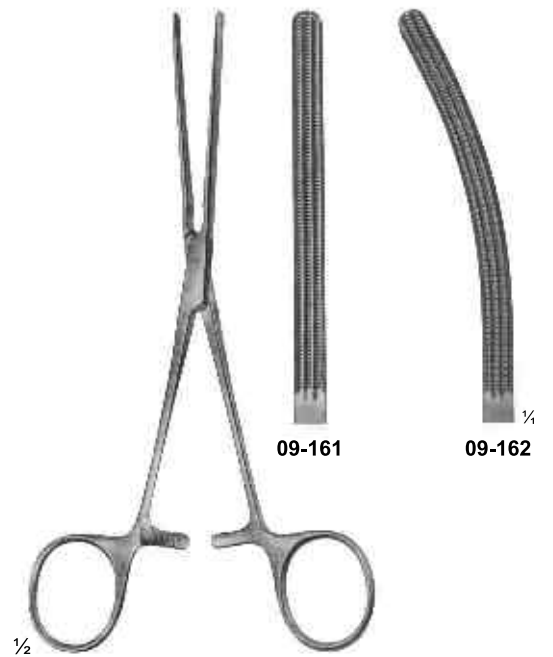

**09-161 - 162**  
DOYEN  
with elastic blades  
170 mm

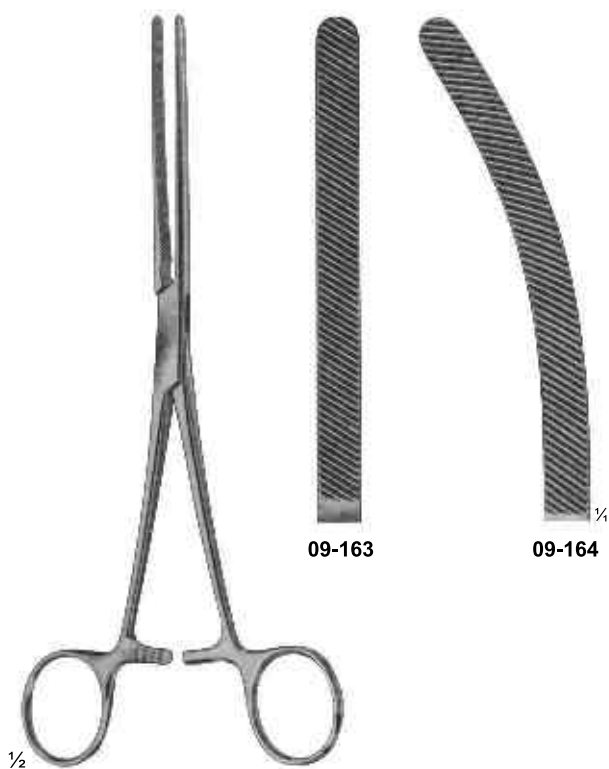

**09-163 - 164**  
HARTMANN  
with elastic blades  
200 mm

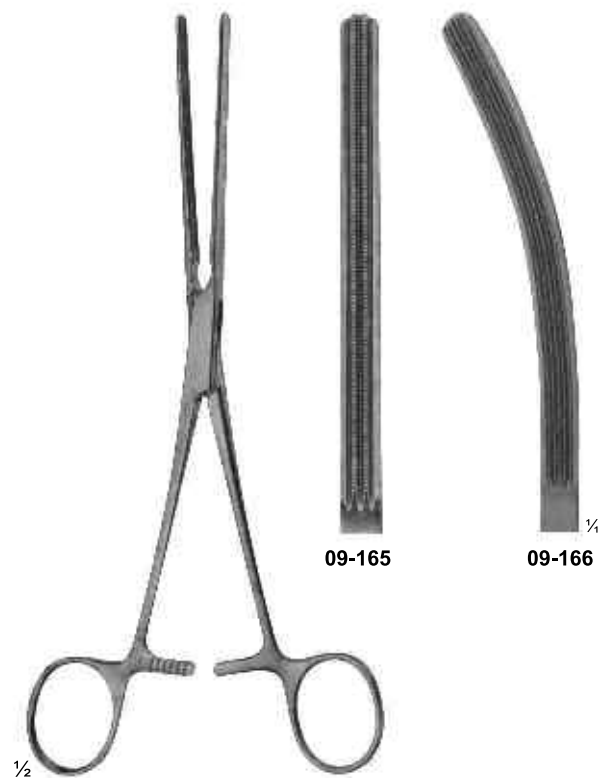

**09-165 - 166**  
HARTMANN  
with elastic blades  
200 mm

# Intestinal Clamps, Soft elastic

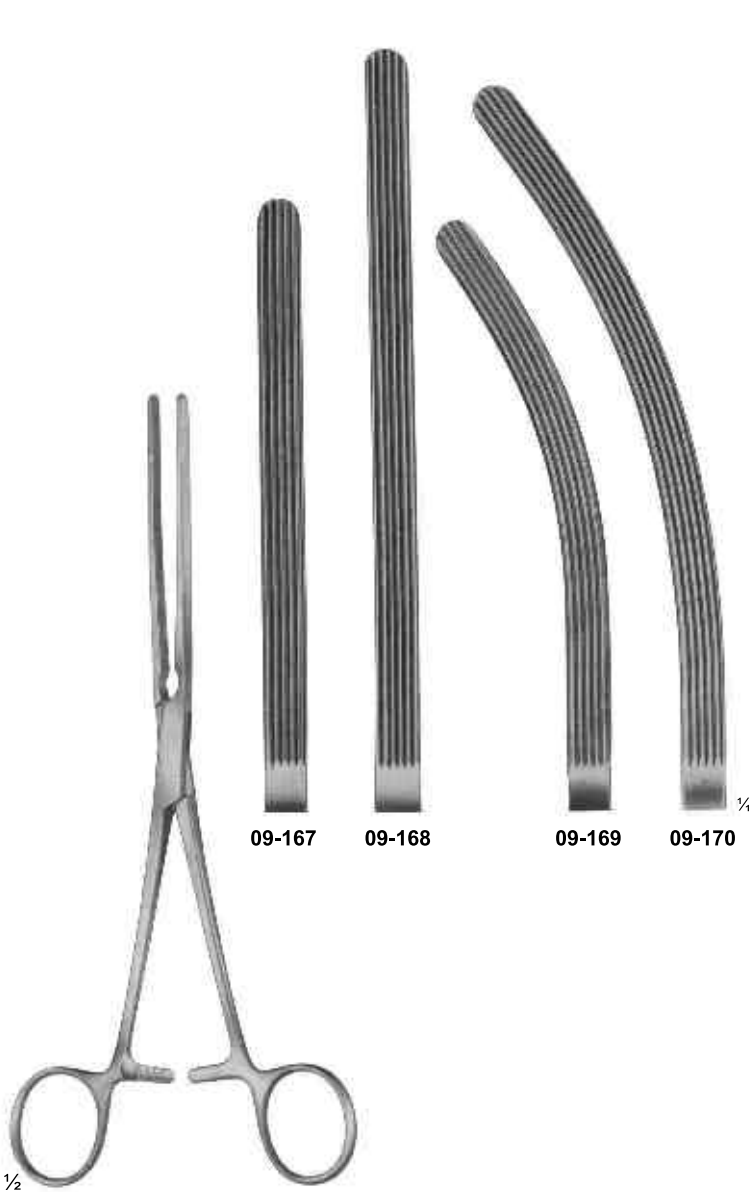

**09-167 - 170**  
KOCHER  
with elastic blades  
**09-169** 210 mm  
**09-170** 230 mm

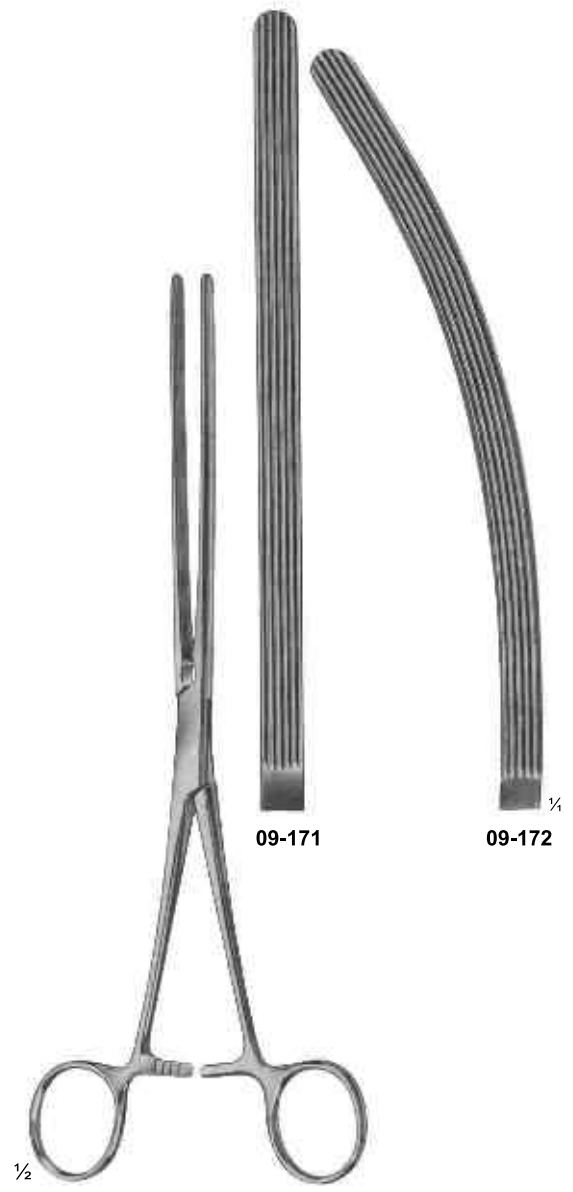

**09-171 - 172**  
DOYEN  
with elastic blades  
210 mm

## Intestinal Clamps, Soft elastic

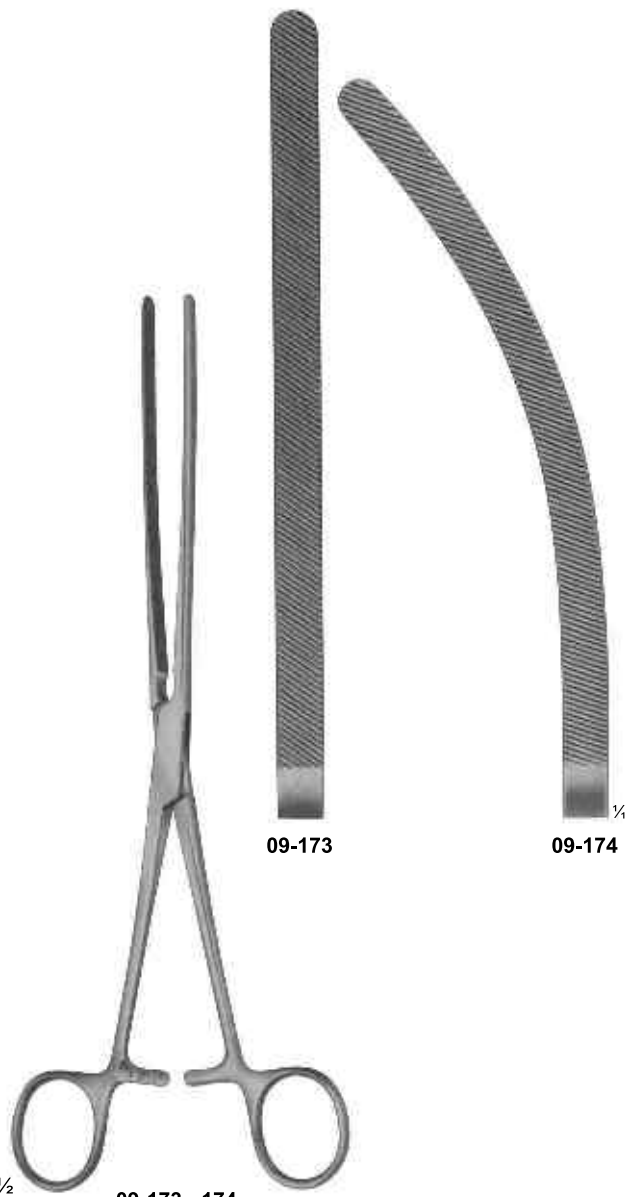

**09-173 - 174**  
DOYEN  
with elastic blades  
235 mm

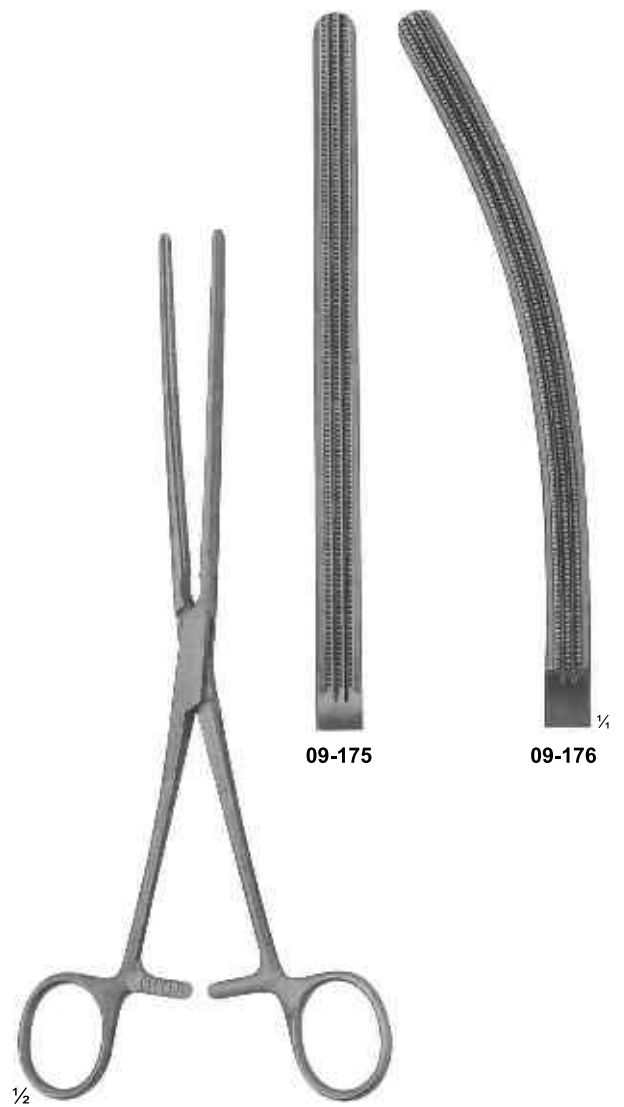

**09-175 - 176**  
DOYEN  
with elastic blades  
230 mm



# Intestinal Clamps, Soft elastic

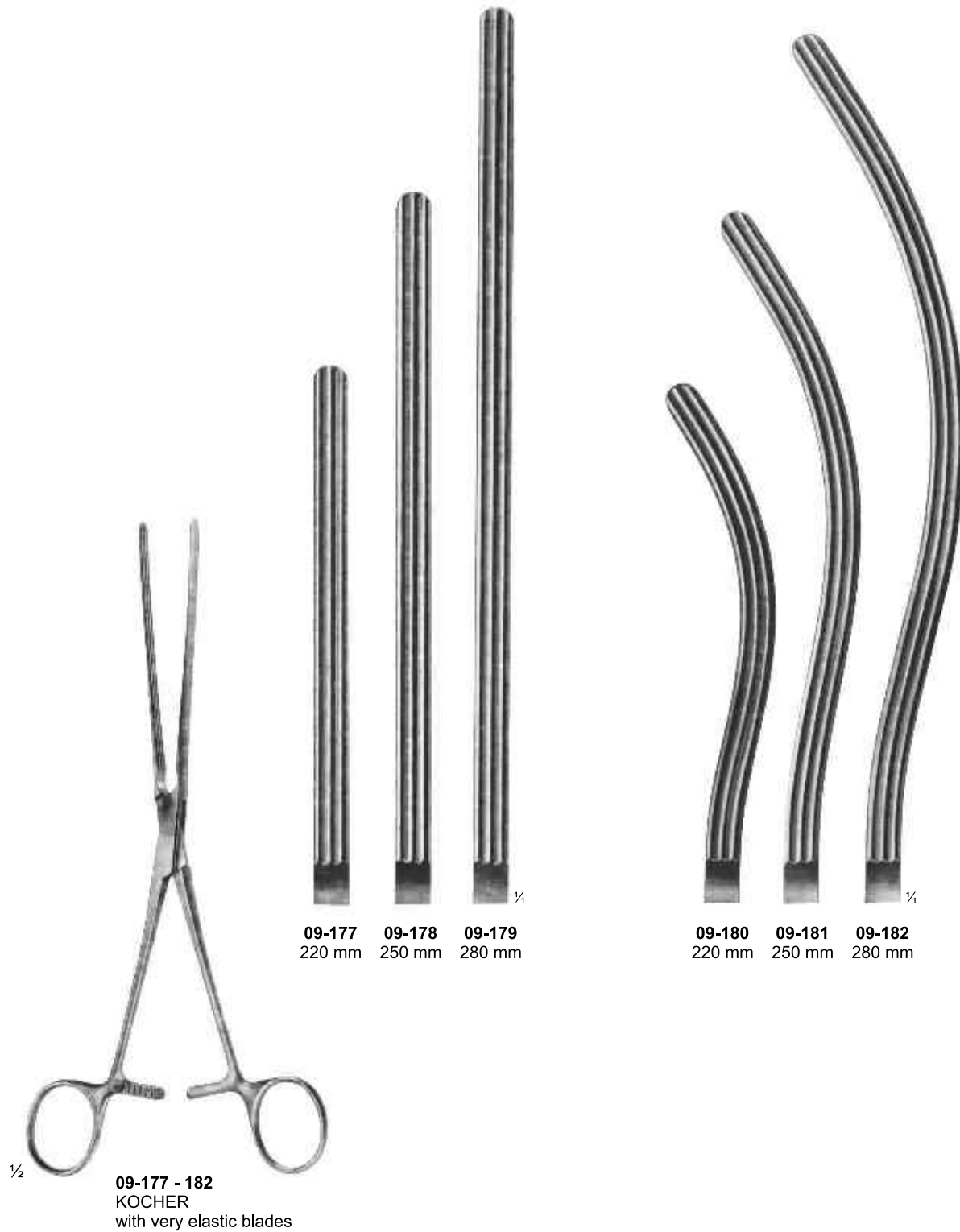

# Intestinal Clamps, Soft elastic

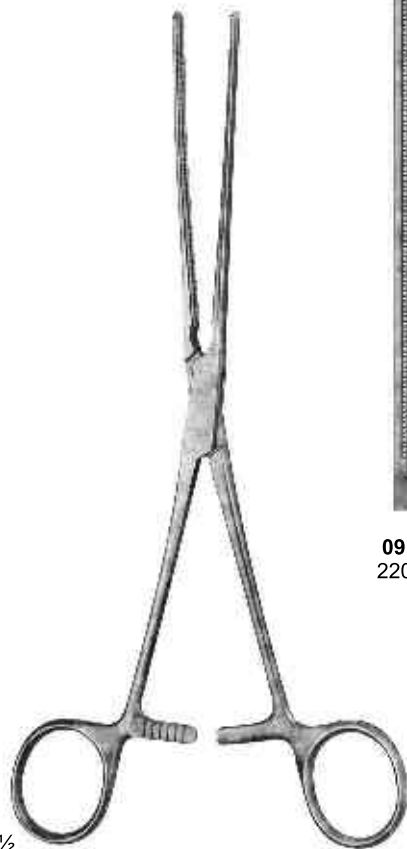

1/2

**09-183 - 188**  
KOCHER  
with very elastic blades

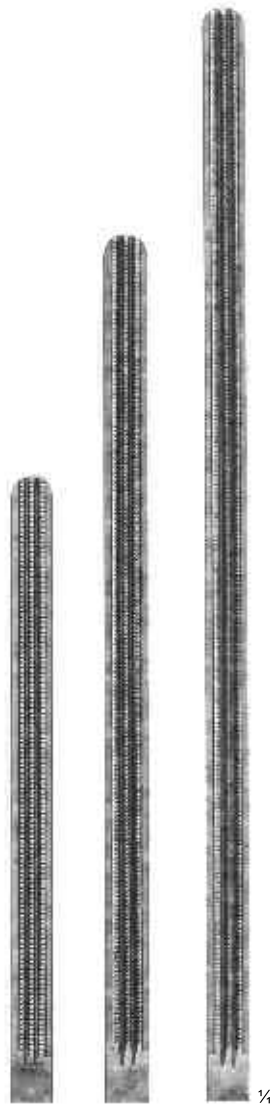

**09-183** 220 mm  
**09-184** 250 mm  
**09-185** 280 mm

1/4



**09-186** 220 mm  
**09-187** 250 mm  
**09-188** 280 mm

1/4

# Intestinal Clamps

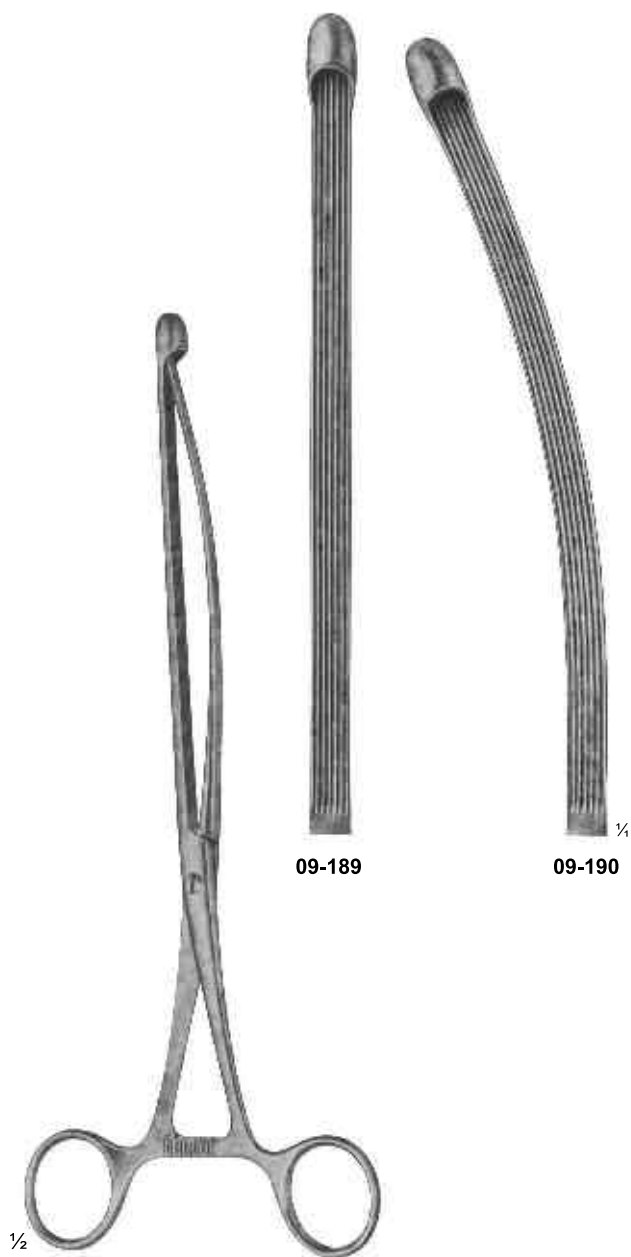

**09-189 - 190**  
NUSSBAUM  
with elastic blades  
250 mm

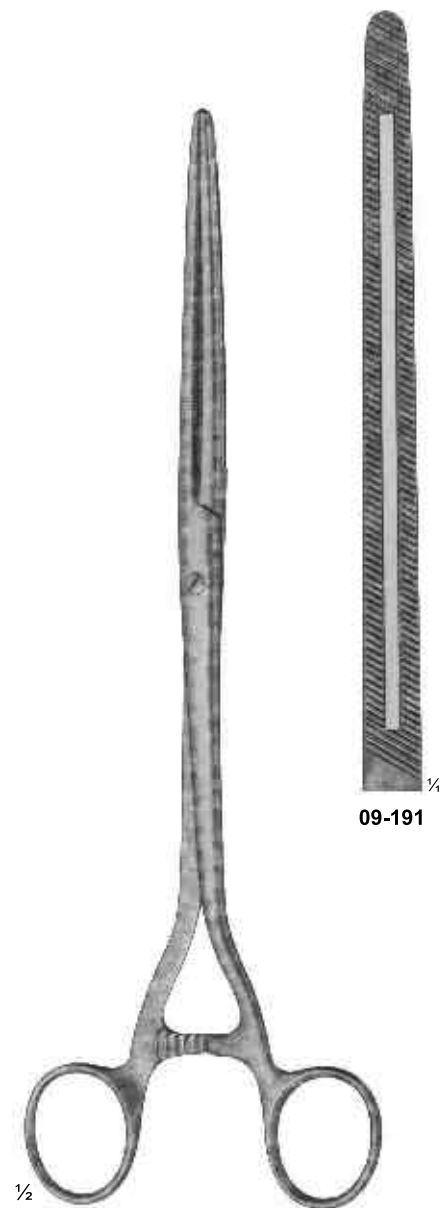

**09-191**  
MOYNIHAN  
280 mm

# Intestinal Clamps

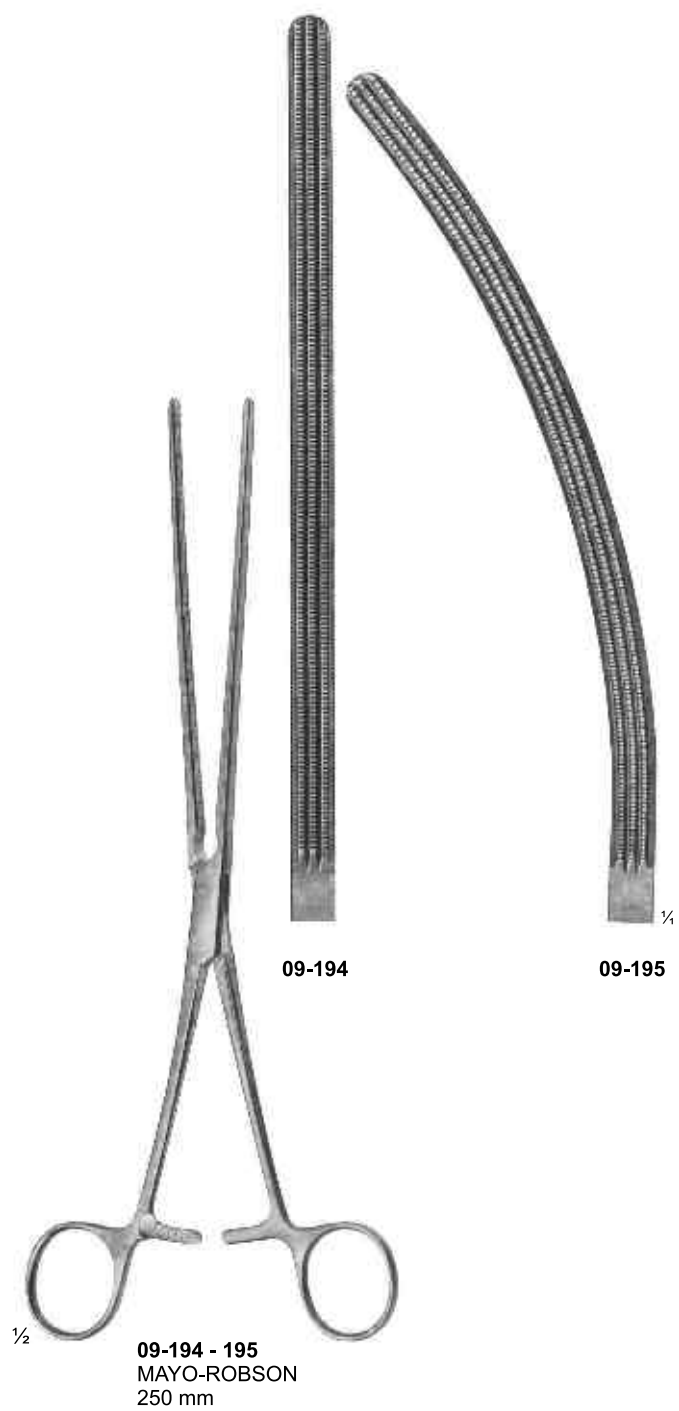
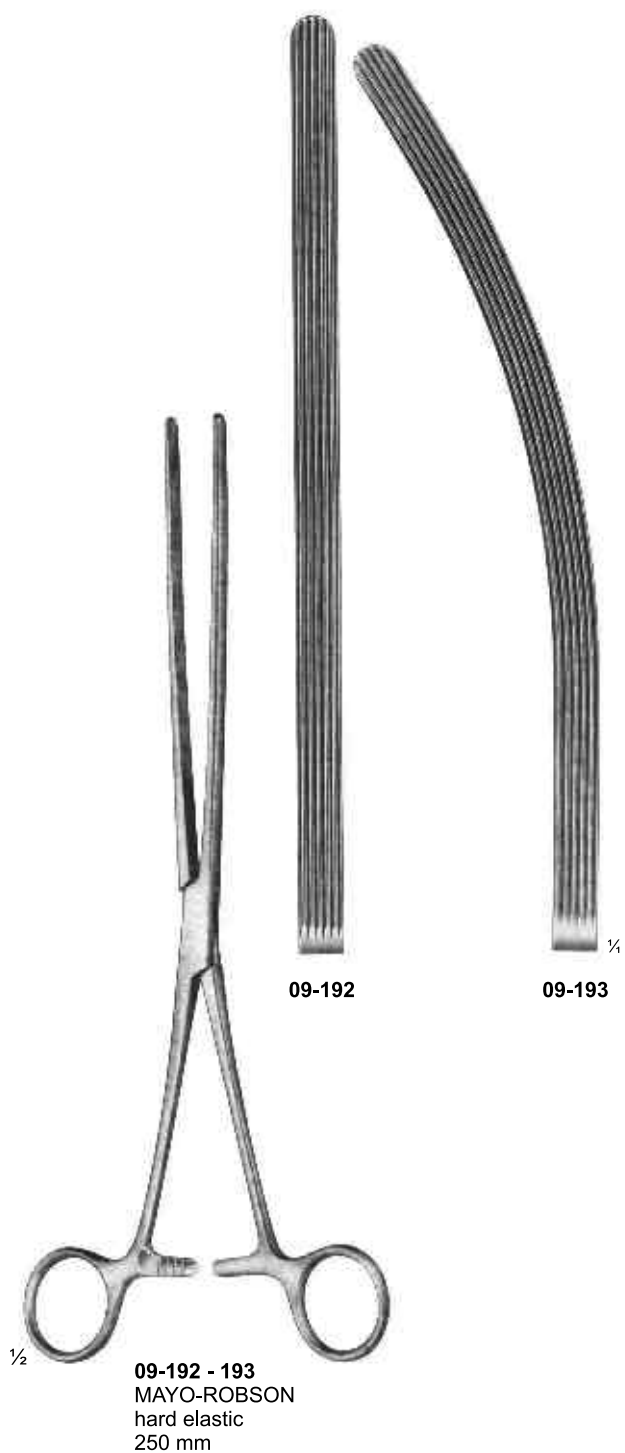

# Gastro-Intestinal Forceps, twin



**09-196**  
LANE  
300 mm

**09-197**  
LANE  
300 mm



# Intestinal and Pylorus Clamps



**09-201**  
PAYR  
Intestinal clamp  
light pattern,  
for children  
180 mm

**09-202**  
PAYR  
200 mm

**09-203**  
PAYR  
275 mm

**09-204**  
PAYR  
Pylorus clamp  
315 mm

# Anastomosis Forceps

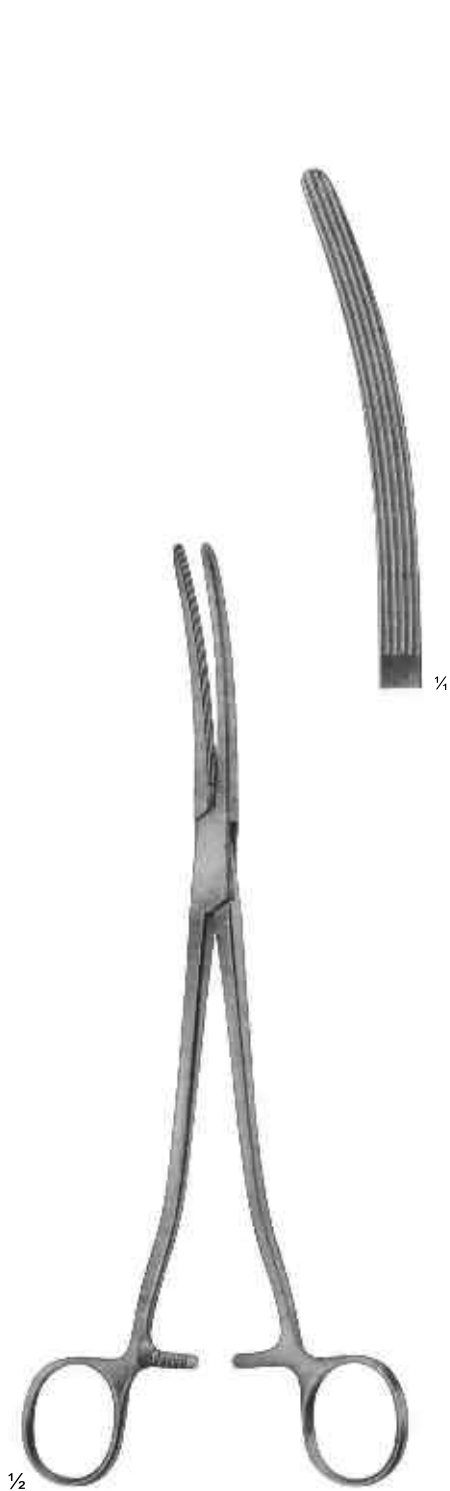

**09-205**  
**PARKER-KERR**  
 anastomosis forceps  
 for colon resection  
 180 mm

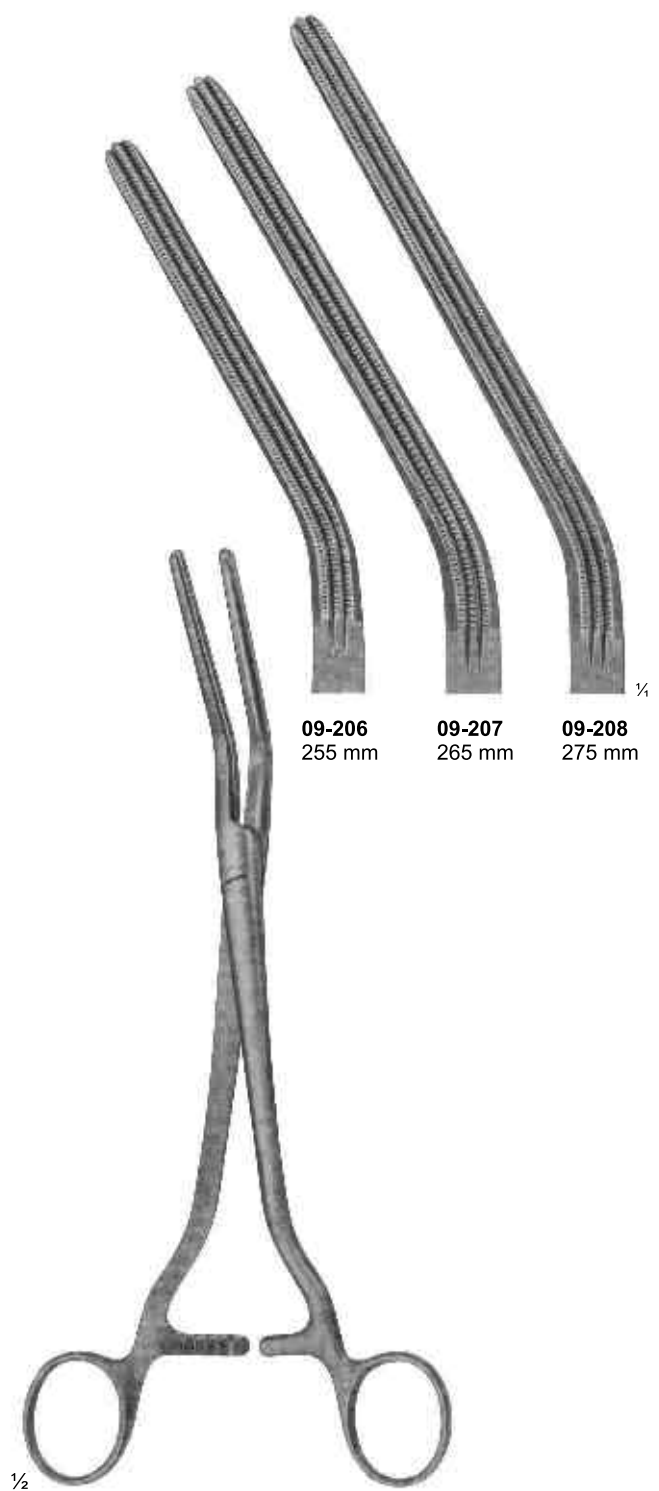

**09-206** 255 mm  
**09-207** 265 mm  
**09-208** 275 mm

**09-206 - 208**  
**DICK**  
 pressure clamps  
 180 mm



# Sigmoid Anastomosis Forceps



# Sigmoid Anastomosis Forceps

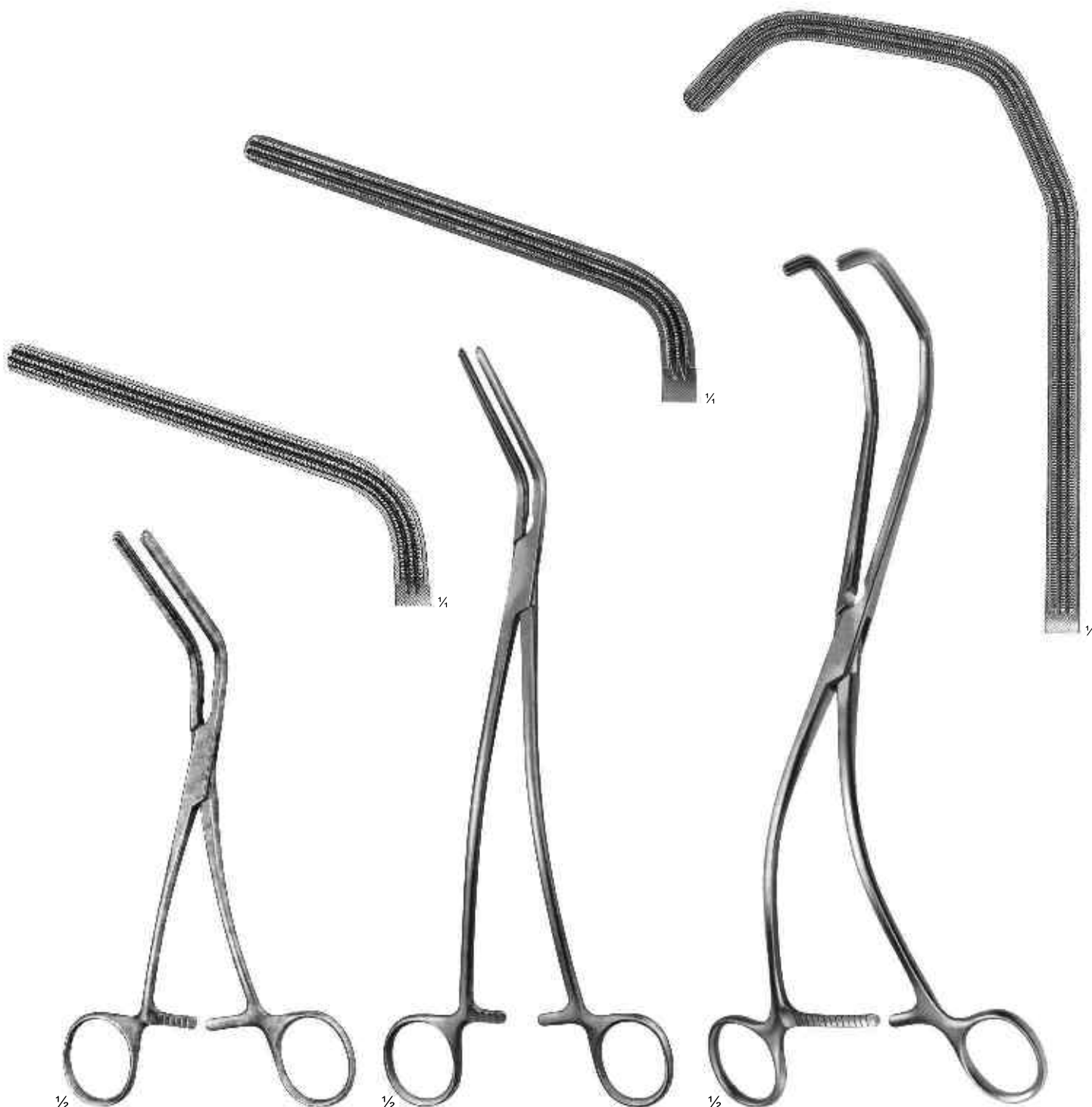

**09-212**  
MORRIS  
175 mm

**09-213**  
DE BAKEY  
(MORRIS modif.)  
240 mm

**09-214**  
KERSTING  
270 mm

# Rectal Specula

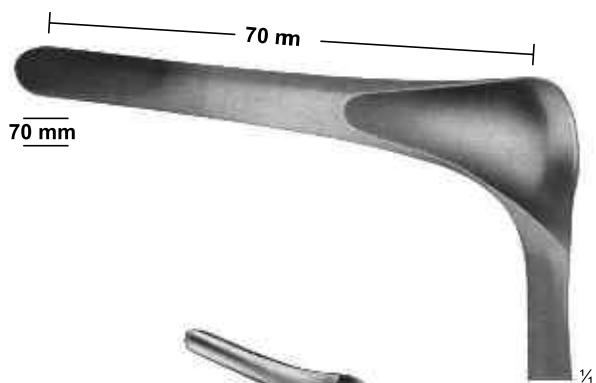

10-101  
KILLIAN  
for children  
145 mm



10-102  
SIMS  
160 mm



10-103  
SIMS  
160 mm

# Rectal Specula



10-104 - 107

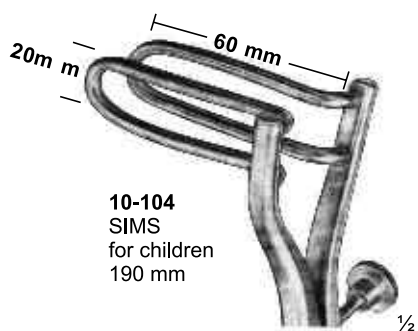

10-104  
SIMS  
for children  
190 mm

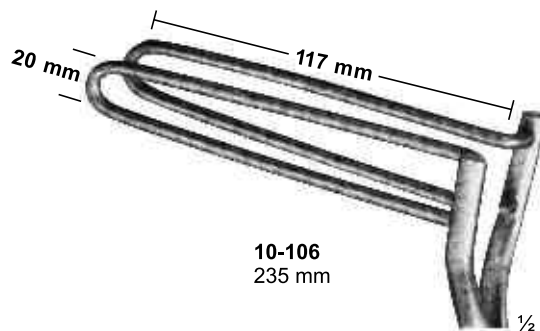

10-106  
235 mm

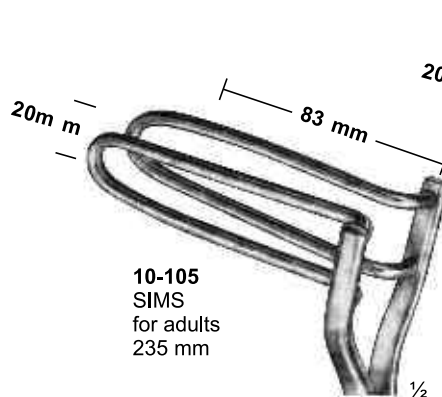

10-105  
SIMS  
for adults  
235 mm

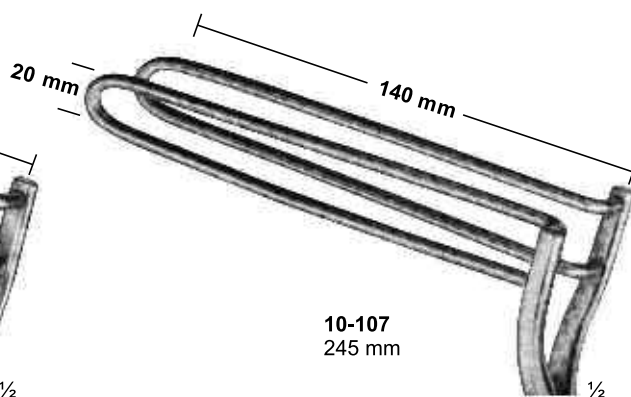

10-107  
245 mm



10-108  
PRATT  
205 mm

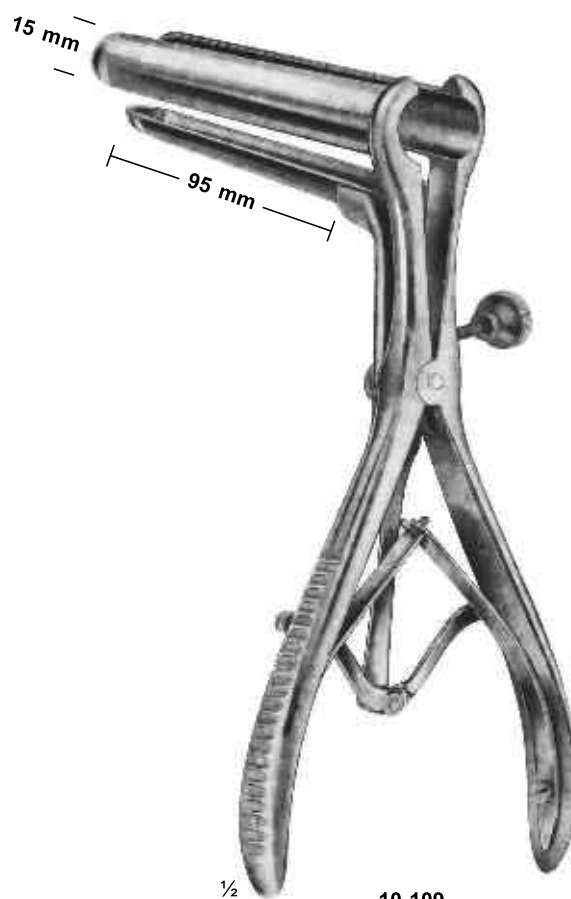

10-109  
MATHIEU  
215 mm

# Anuscopy-Sphincteroscopes



1/2

**10-110**  
IVES-FANSLER  
Anuscopy  
145 mm

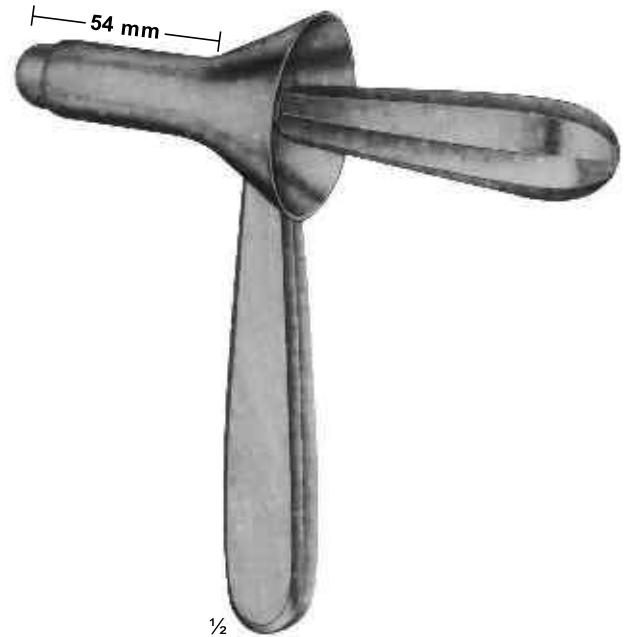

1/2

**10-111**  
KELLY  
Sphincteroscope  
160 mm



1/2

**10-112**  
KELLY  
Sphincteroscope  
160 mm

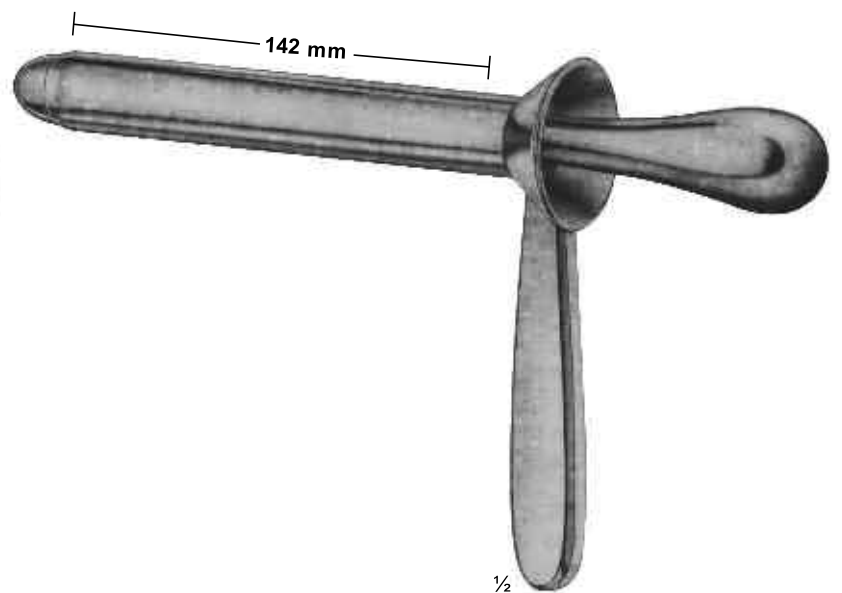

1/2

**10-113**  
KELLY  
Proctoscope  
160 mm

# Biopsy forceps for rectum

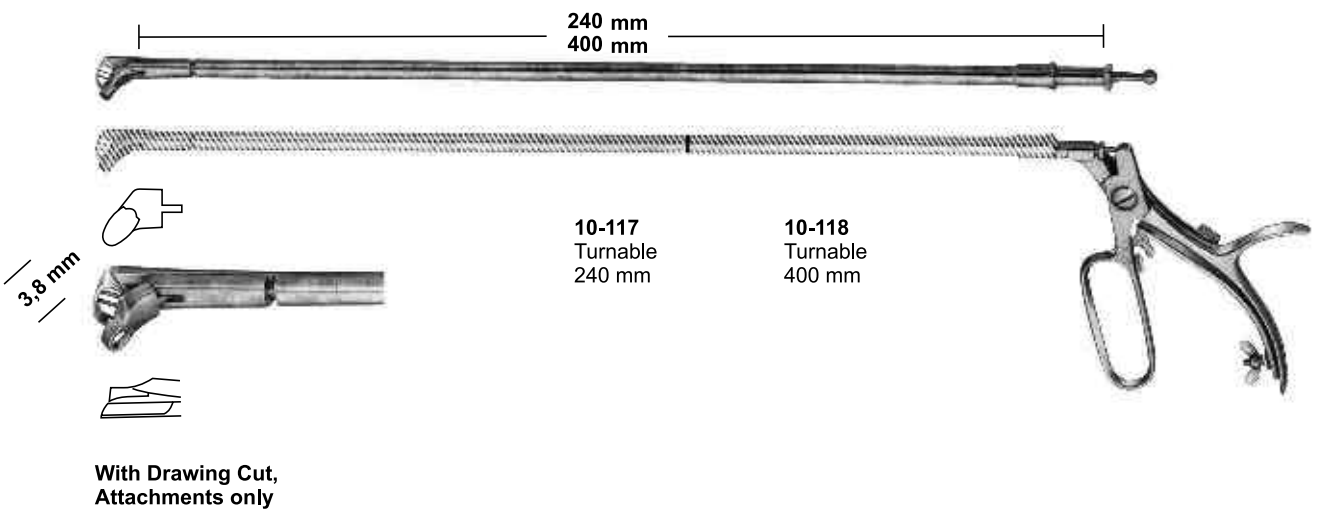
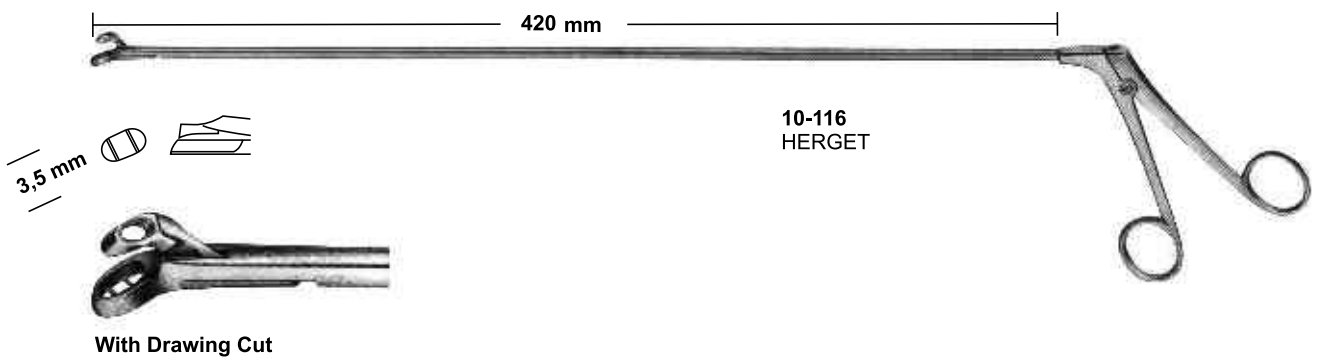
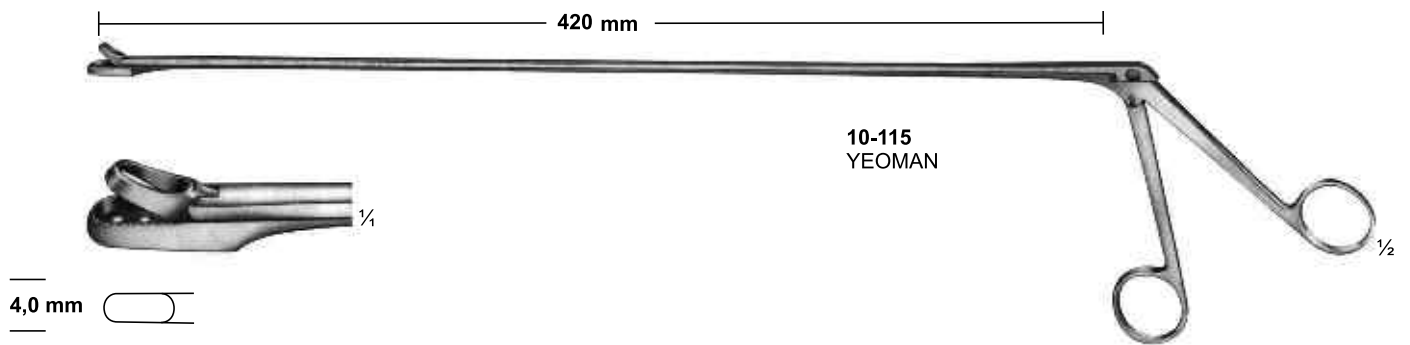
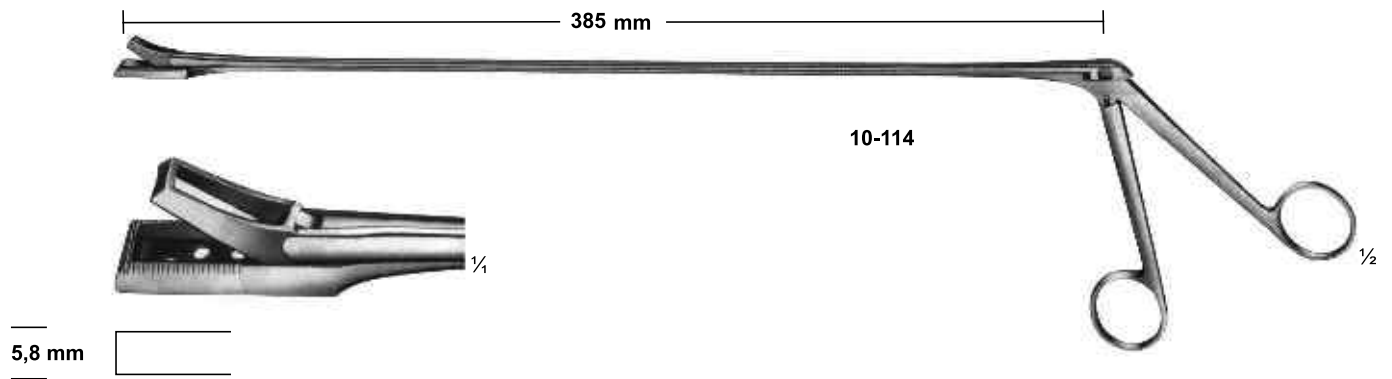

# Biopsy Forceps & Swab Holders

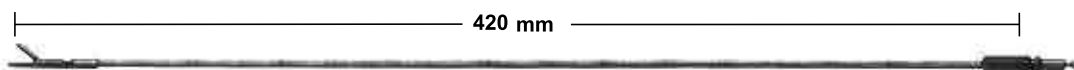

3,5 mm

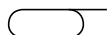

10-119

3,5 mm

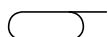

10-120

4,0 mm



10-121

4,0 mm

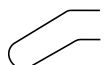

10-122



10-119 - 122  
Handle for 119 - 120 - 121 - 122

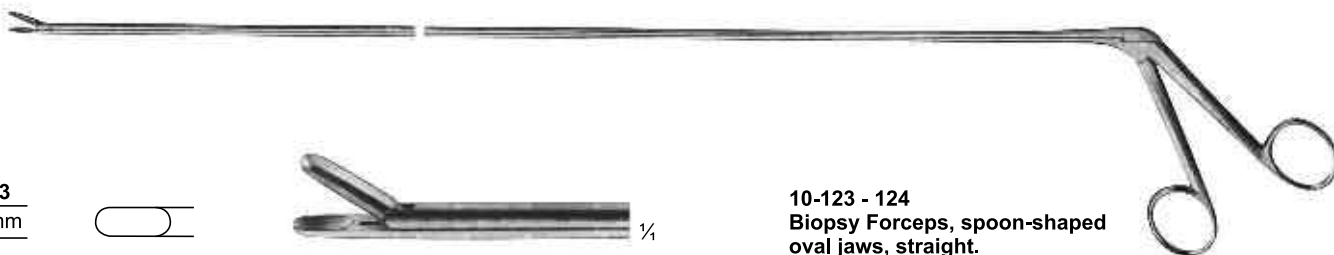

10-123  
3,5 mm

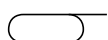

10-123 - 124  
Biopsy Forceps, spoon-shaped  
oval jaws, straight.

10-124  
4, mm

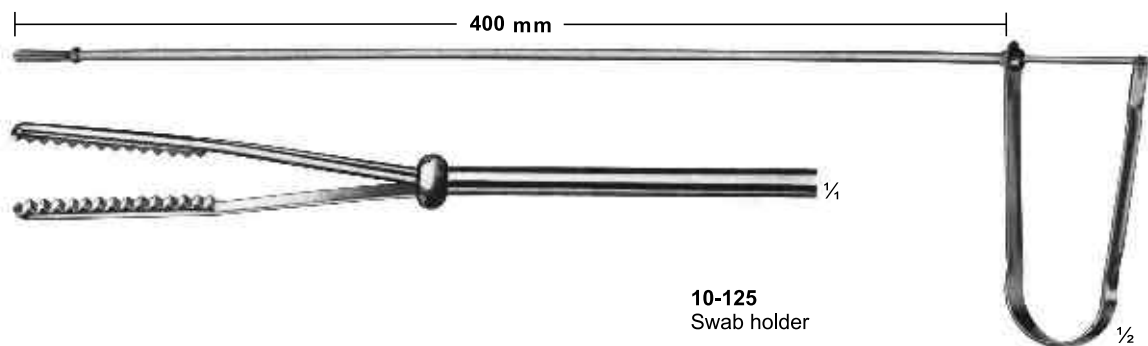

10-125  
Swab holder

# Haemorrhoidal Forceps

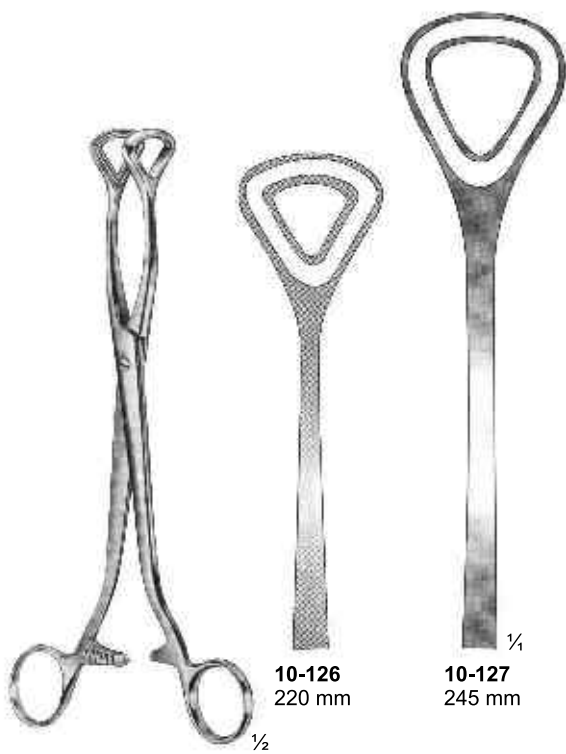

**10-126 - 127**  
LUER

**10-126**  
220 mm

**10-127**  
245 mm

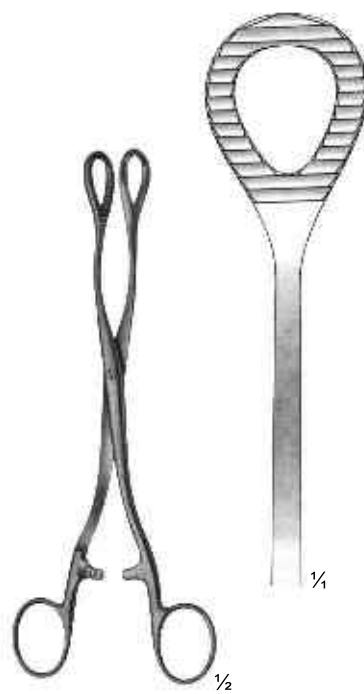

**10-128**  
HEYWOOD-SMITH  
200 mm

1/4

1/2



**10-129**  
HEYWOOD-SMITH  
modif  
200 mm

1/4

1/2



# Haemorrhoidal Forceps

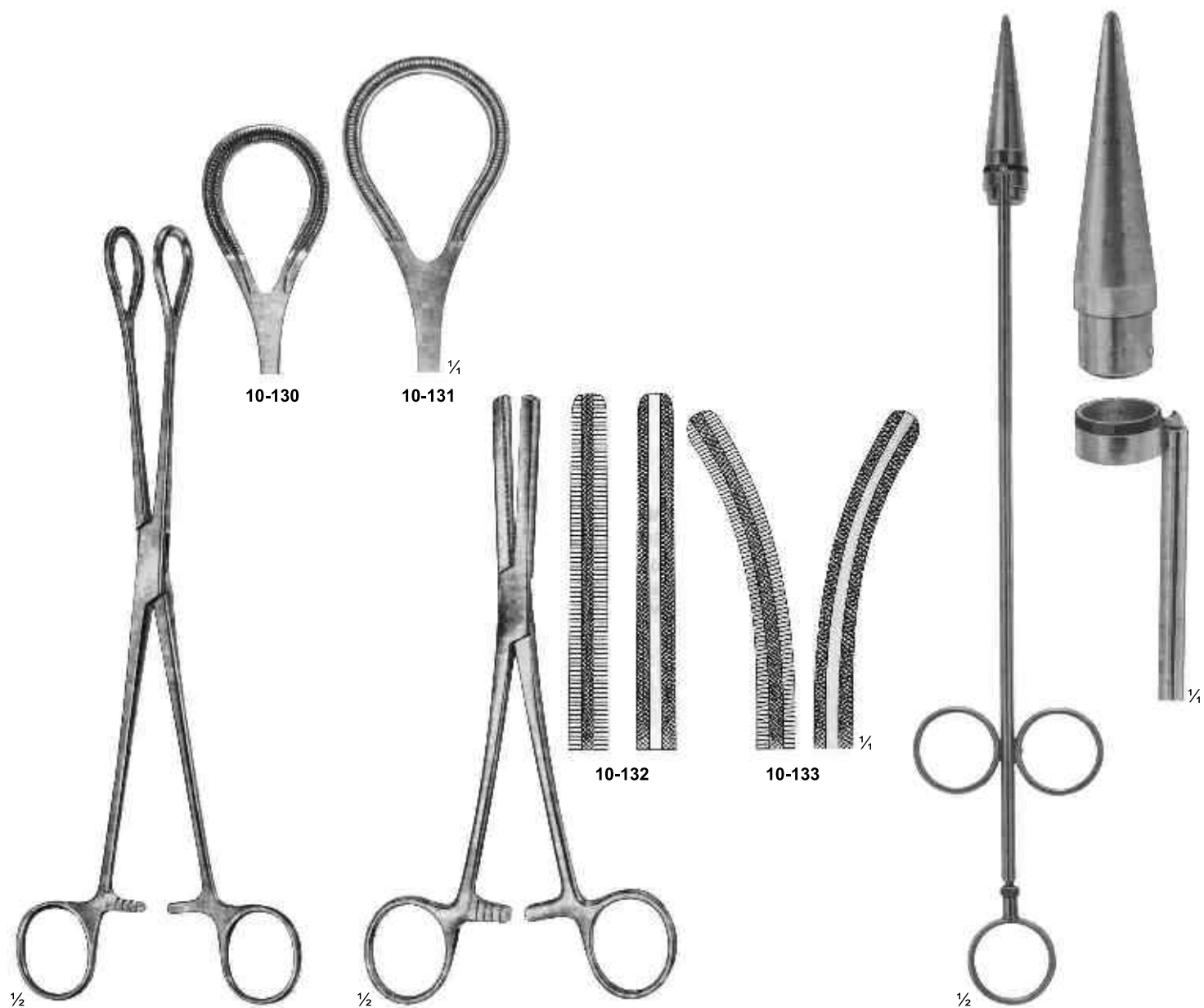

**10-130 - 131**  
250 mm  
**10-131**  
270 mm

**10-132 - 133**  
**FERGUSSON**  
200 mm

**10-134**  
**RUDD**  
Haemorrhoidal ligator  
with loading  
attachment and 100  
ligature rubber rings  
315 mm

# Gall Duct Forceps



**10-135**  
LOWER  
180 mm



**10-136**  
LAHEY ( SWEET )  
190 mm

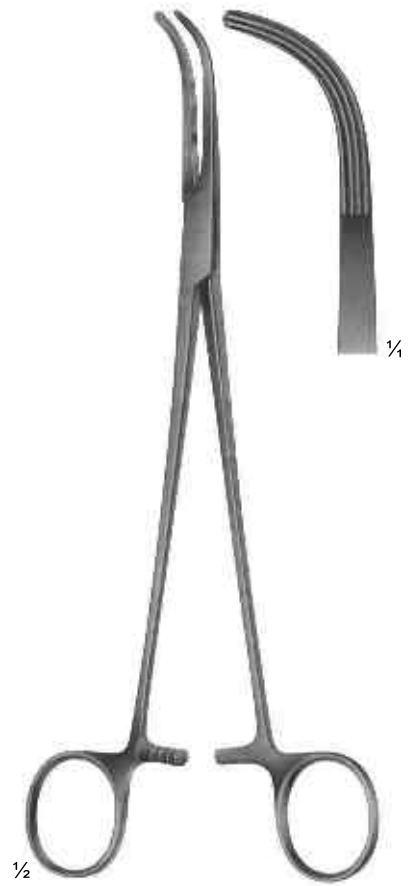

**10-137**  
LAHEY  
220 mm



**10-138**  
DESJARDINS  
Gall duct-and cystic forceps  
210 mm



**10-139**  
NISSEN  
Gall duct-and cystic forceps  
215 mm

# Gall Duct Forceps and Choledochus Forceps



10-140



10-141

1/2  
10-140-141  
GRAY  
180 mm



10-142 10-143

1/2  
10-142-143  
MIXTER  
Gall duct-and cystic forceps  
230 mm



10-144

1/2  
10-144  
FOERSTER-BALLENGER  
240 mm

# Gall Bladder Forceps and Gall Duct Scissors

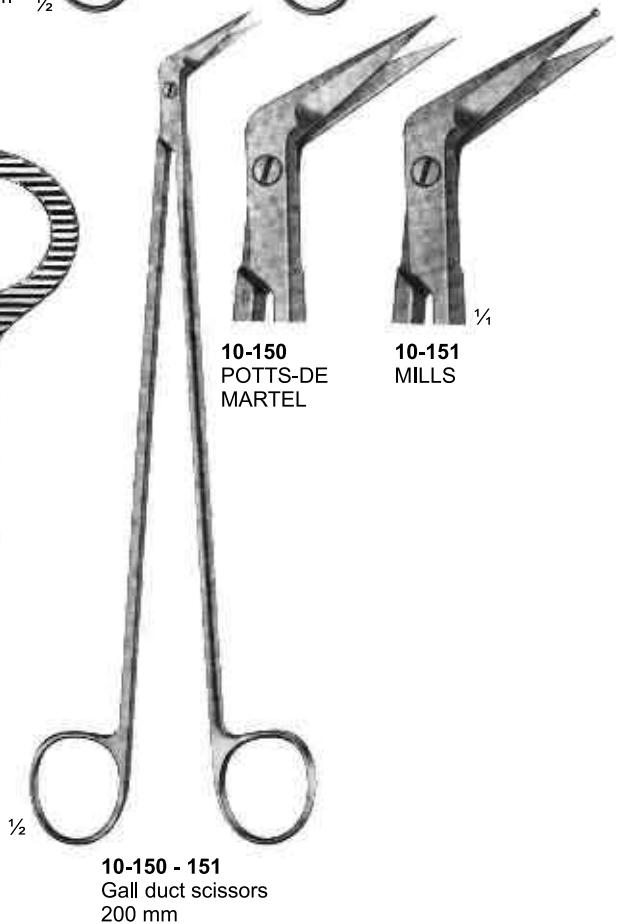
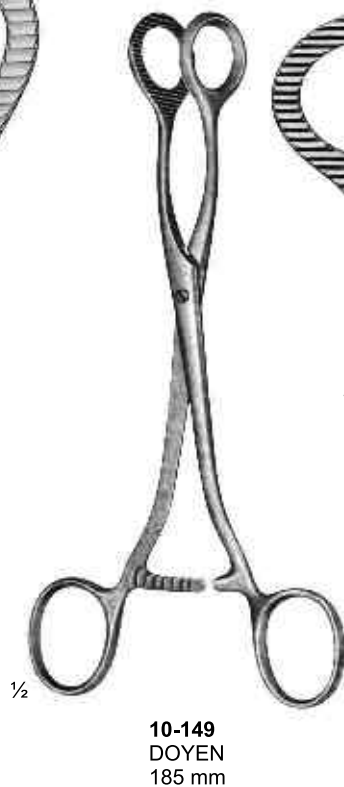
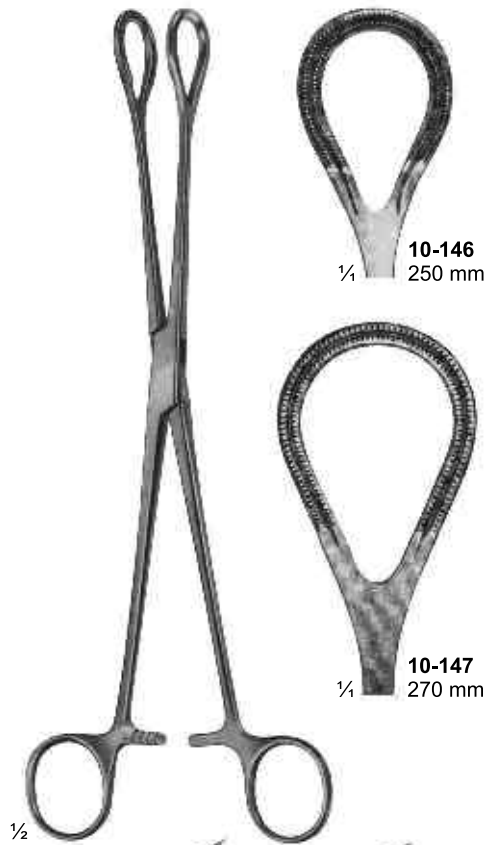
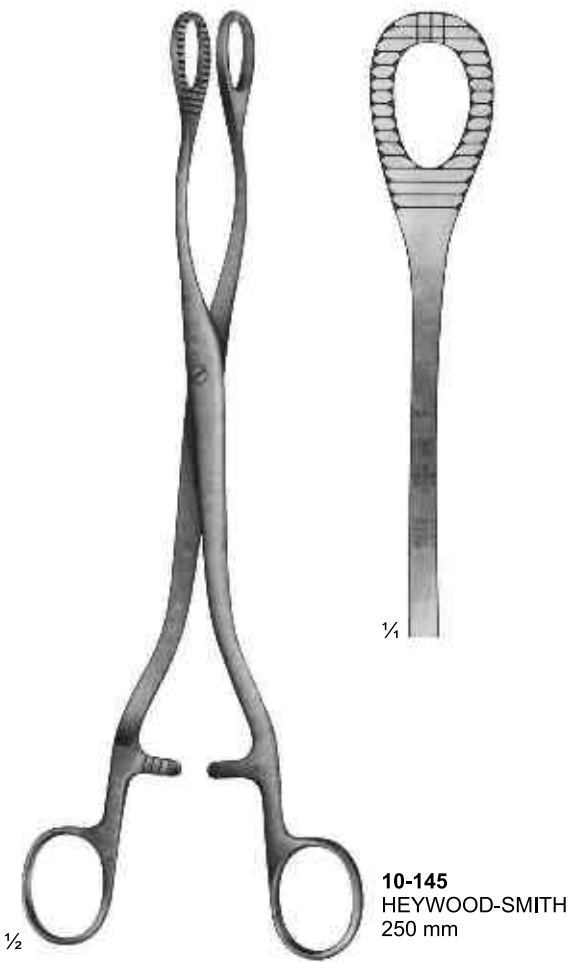

# Gall Duct Probes

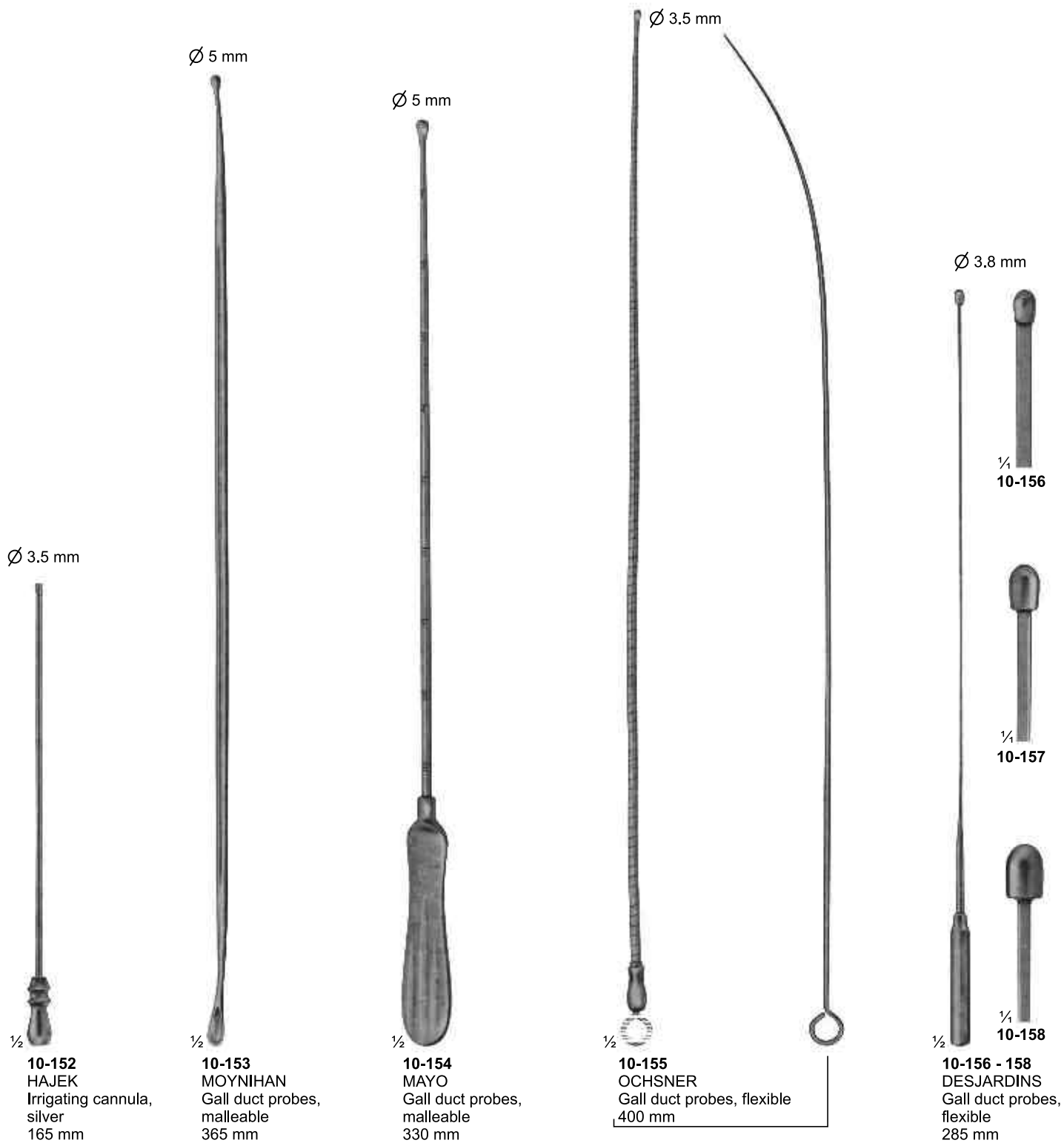

# Gall Duct Dilators & Gall Stone Scoops

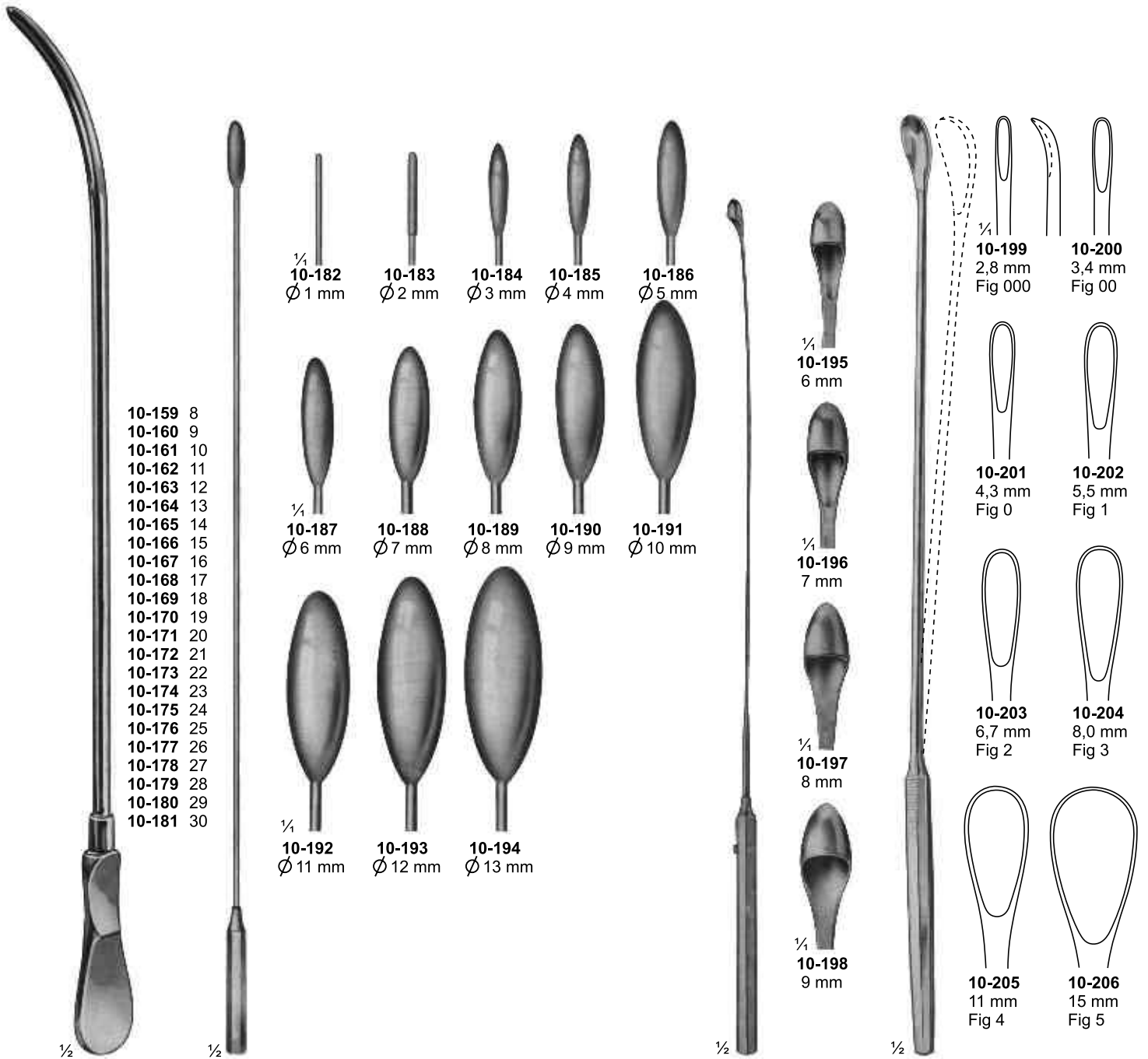

- 10-159 8
- 10-160 9
- 10-161 10
- 10-162 11
- 10-163 12
- 10-164 13
- 10-165 14
- 10-166 15
- 10-167 16
- 10-168 17
- 10-169 18
- 10-170 19
- 10-171 20
- 10-172 21
- 10-173 22
- 10-174 23
- 10-175 24
- 10-176 25
- 10-177 26
- 10-178 27
- 10-179 28
- 10-180 29
- 10-181 30

1/4  
10-182  
Ø 1 mm

10-183  
Ø 2 mm

10-184  
Ø 3 mm

10-185  
Ø 4 mm

10-186  
Ø 5 mm

1/4  
10-187  
Ø 6 mm

10-188  
Ø 7 mm

10-189  
Ø 8 mm

10-190  
Ø 9 mm

10-191  
Ø 10 mm

1/4  
10-192  
Ø 11 mm

10-193  
Ø 12 mm

10-194  
Ø 13 mm

1/4  
10-195  
6 mm

1/4  
10-196  
7 mm

1/4  
10-197  
8 mm

1/4  
10-198  
9 mm

1/4  
10-199  
2,8 mm  
Fig 000

10-200  
3,4 mm  
Fig 00

10-201  
4,3 mm  
Fig 0

10-202  
5,5 mm  
Fig 1

10-203  
6,7 mm  
Fig 2

10-204  
8,0 mm  
Fig 3

10-205  
11 mm  
Fig 4

10-206  
15 mm  
Fig 5

**10-159 - 181**  
**DITTEL**  
Metall bougies and dilating sounds, stiff 345 mm

**10-182 - 194**  
**BAKES**  
Common bile duct dilators, malleable 315 mm, 320 mm

**10-195 - 198**  
**DESJARDINS**  
Probes and catch with flexible shaft 300 mm

**10-199 - 206**  
**LUER-KORTE modif**  
with malleable shaft 310 mm

# Gall Stone Forceps

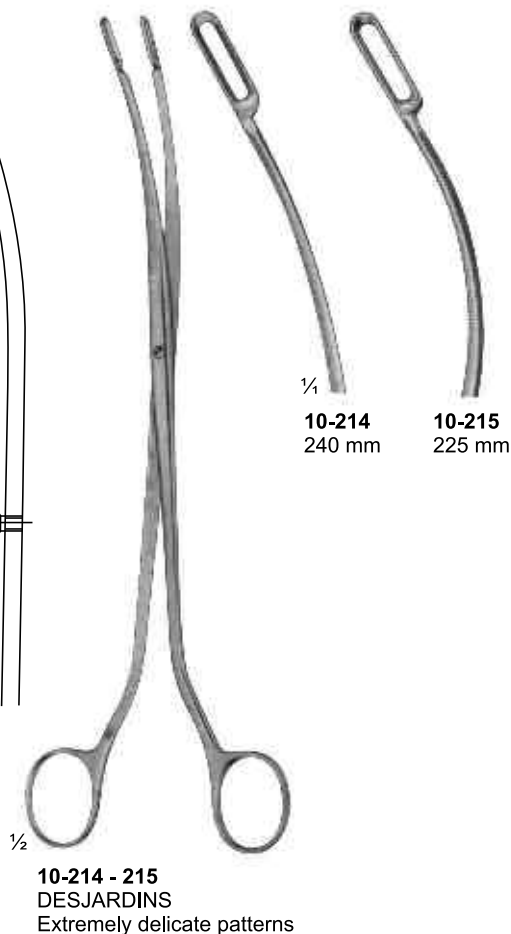
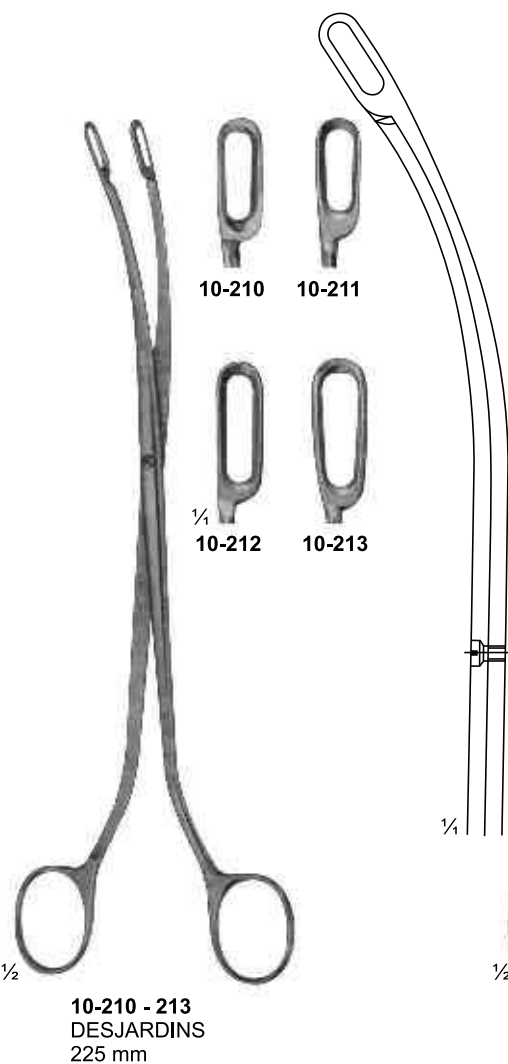
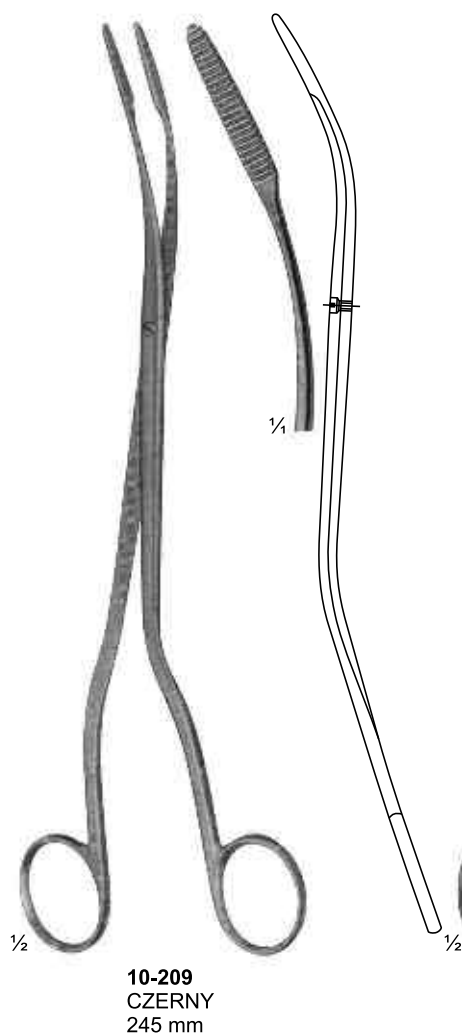
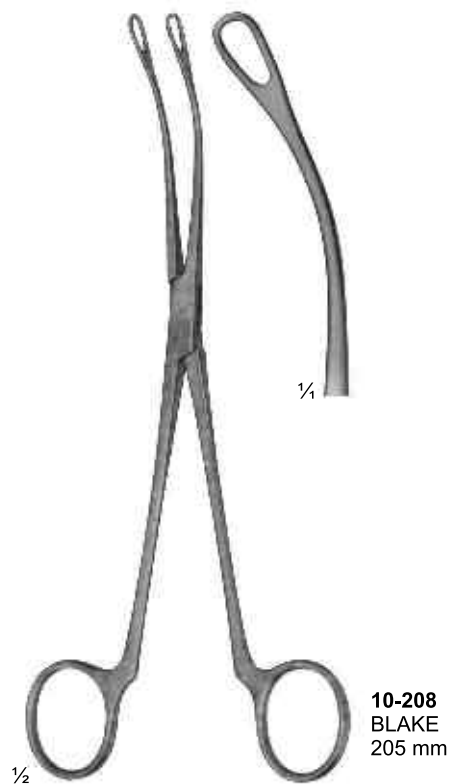
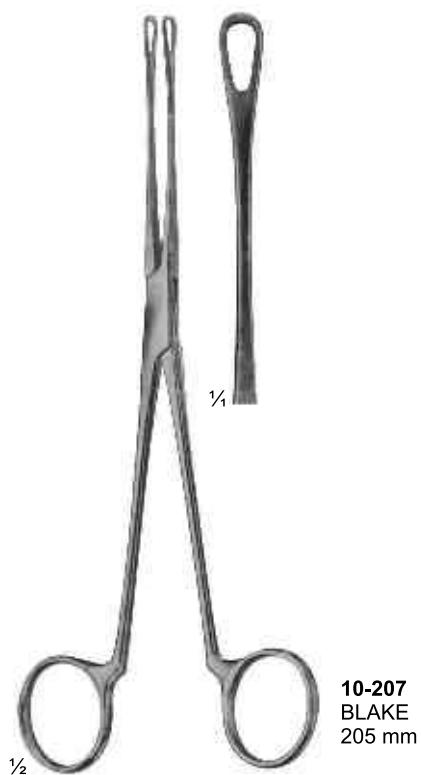

# Kidney Clamps

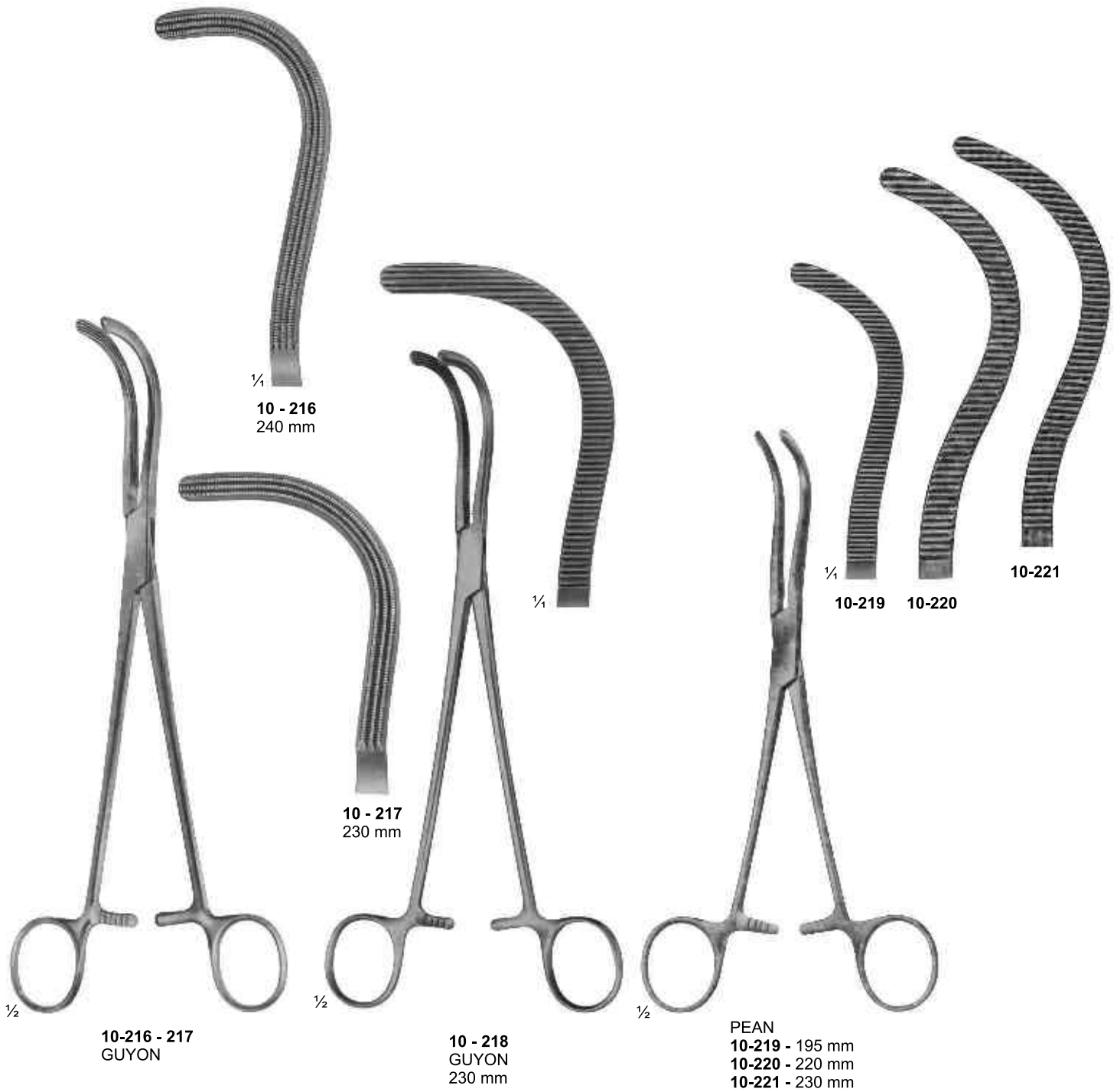



# Kidney Clamps

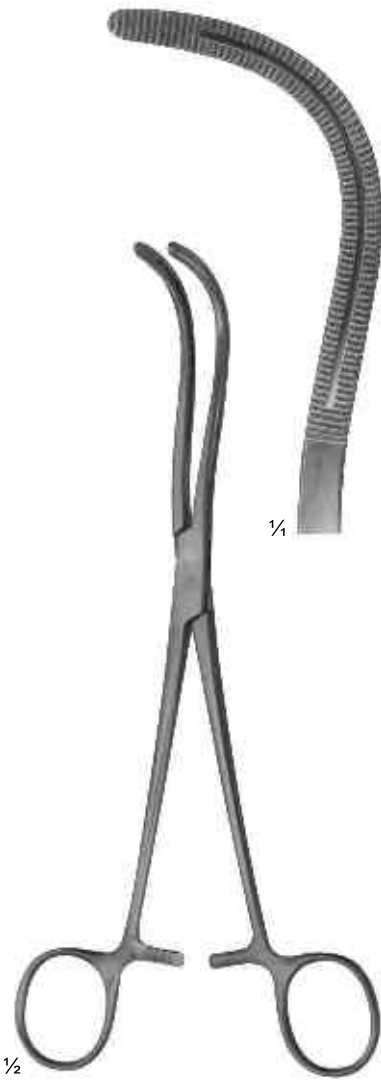

**10-222**  
STILLE  
220 mm

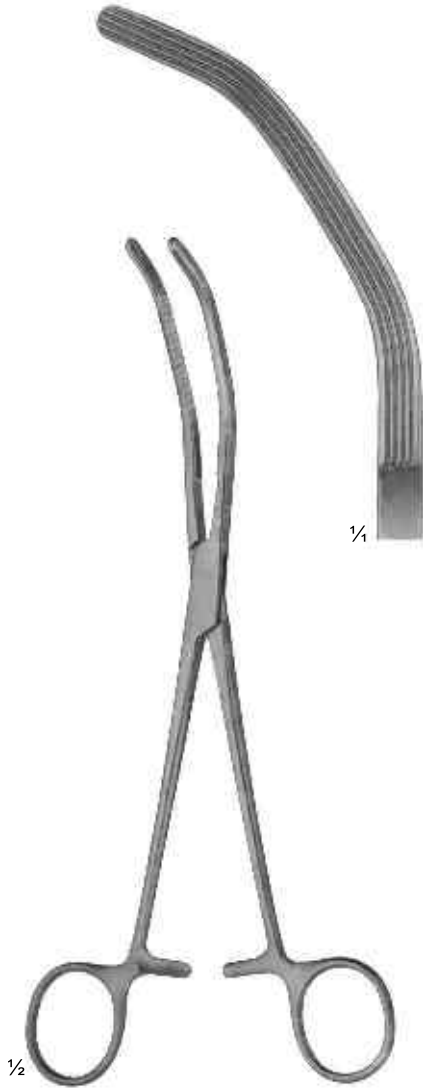

**10-223**  
HERRICK  
225 mm

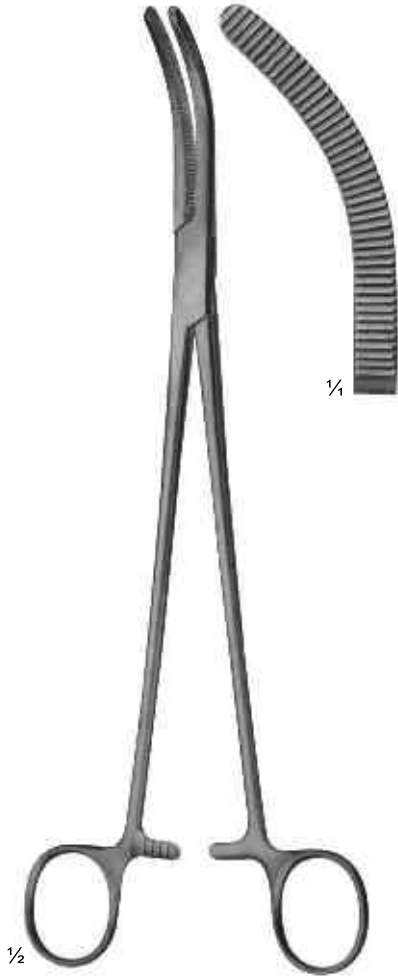

**10-224**  
WERTHEIM  
225 mm

# Kidney Elevating Forceps



1/2

**10-225**  
COLLIN  
285 mm



1/2

**10-226**  
DARTIGUES  
255 mm

# Kidney Stone Forceps



10-227



10-228



10-229



$\frac{1}{4}$   
10-230



10-231



10-232

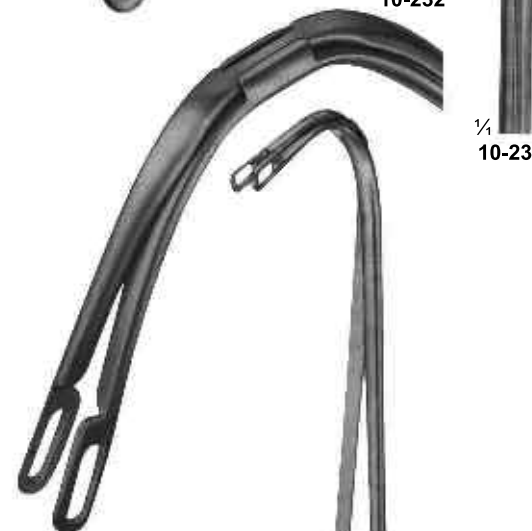

$\frac{1}{4}$   
10-233



$\frac{1}{2}$

10-227 - 230  
RANDALL  
225 mm



$\frac{1}{2}$

10-231 - 233  
RANDALL  
190 mm

# Bladder Retractors

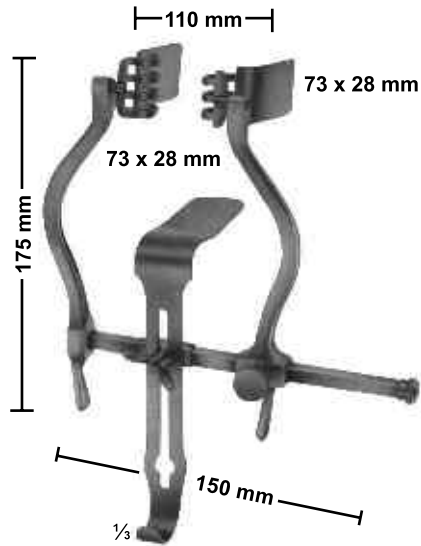

**11-101**  
**JUDD-MASSON**  
 Bladder and suprapubic  
 retractor



**11-102**  
**MILLIN**  
 Bladder retractor  
 105X45 mm



**11-103**  
**LEGUEU**  
 Bladder retractor  
 Center blade  
 80 x 31 mm

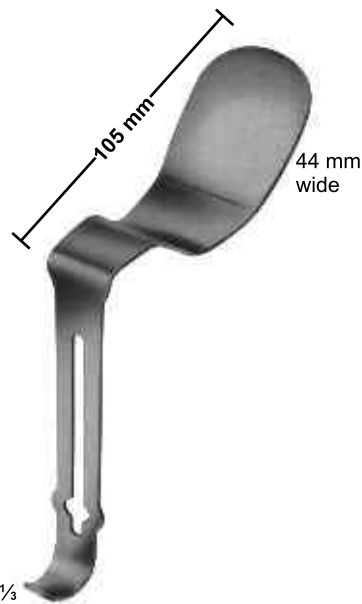

**11-104**  
**MILLIN**  
 Center bladder for  
 retro pubic prostatectomy



**11-105**  
**KOCHER**  
 Bladder spatula  
 235 mm

# Genito-Urinary Instruments-Prostatectomy



**11-106**  
**MATHIEU**  
 Foreign body forceps  
 Length of shaft  
 190 mm

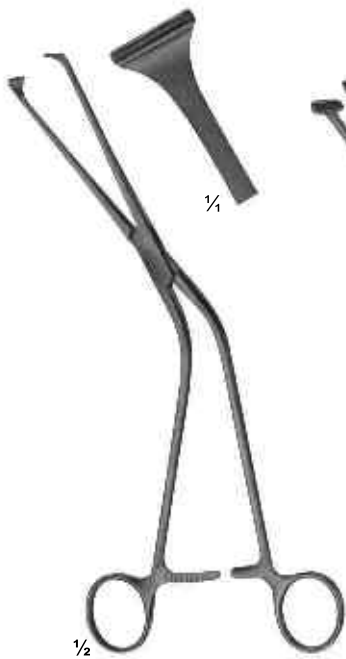

**11-107**  
**MILLIN**  
 Lobe grasping  
 forceps  
 245 mm

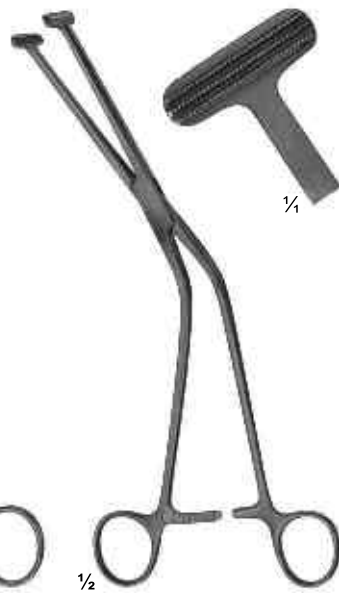

**11-108**  
**MILLIN**  
 Lobe grasping  
 forceps  
 235 mm



**11-109**  
**MILLIN**  
 Bladder neck spreader  
 285 mm

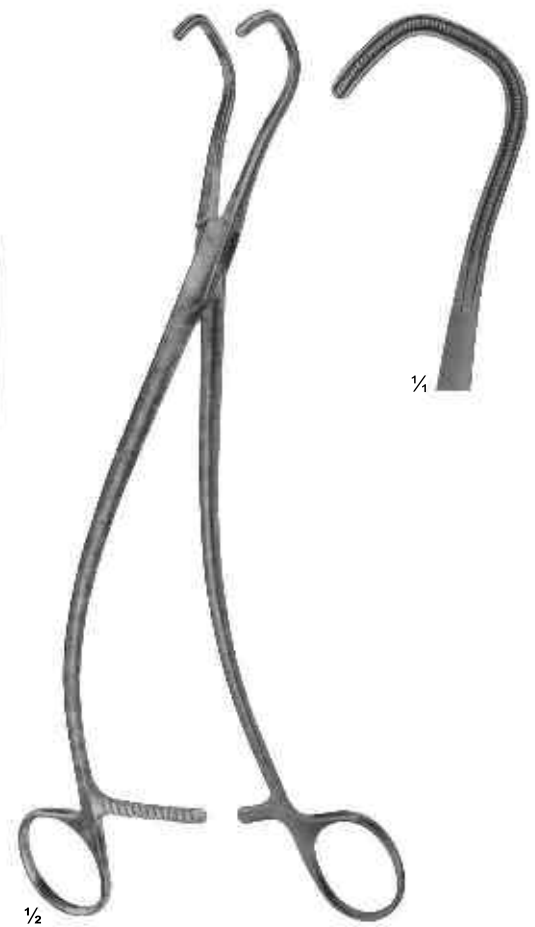

**11-110**  
**Ureter forceps**  
 240 mm

# Genito-Urinary Instruments



1/2

**11-111**  
GUYON  
Catheter guide  
(introducer)  
365 mm

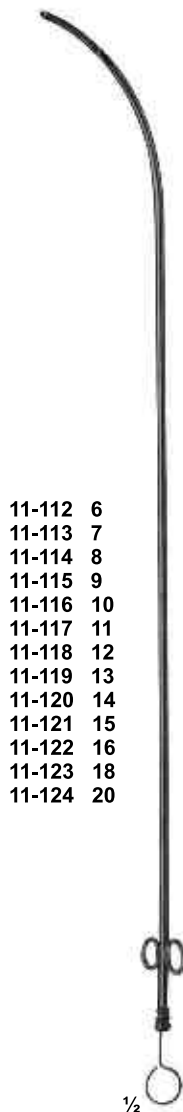

1/2

- 11-112 6
- 11-113 7
- 11-114 8
- 11-115 9
- 11-116 10
- 11-117 11
- 11-118 12
- 11-119 13
- 11-120 14
- 11-121 15
- 11-122 16
- 11-123 18
- 11-124 20

**11-112 - 124**  
Female catheters,  
metal  
160 mm

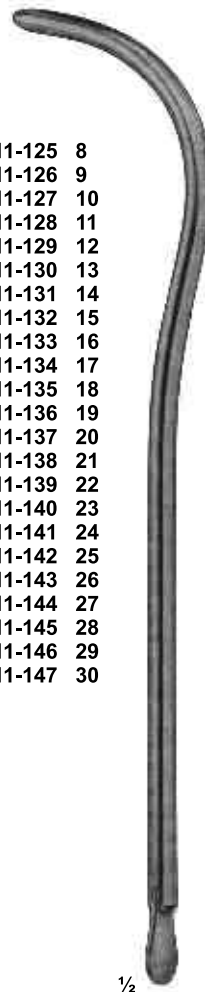

1/2

- 11-125 8
- 11-126 9
- 11-127 10
- 11-128 11
- 11-129 12
- 11-130 13
- 11-131 14
- 11-132 15
- 11-133 16
- 11-134 17
- 11-135 18
- 11-136 19
- 11-137 20
- 11-138 21
- 11-139 22
- 11-140 23
- 11-141 24
- 11-142 25
- 11-143 26
- 11-144 27
- 11-145 28
- 11-146 29
- 11-147 30

**11-125 - 147**  
Urethral bougies  
and dilating sounds  
345 mm

- 11-148 Ben. 24/Charr. 12
- 11-149 Ben. 25
- 11-150 Ben. 26/Charr. 13
- 11-151 Ben. 27
- 11-152 Ben. 28/Charr. 14
- 11-153 Ben. 29
- 11-154 Ben. 30/Charr. 15
- 11-155 Ben. 31
- 11-156 Ben. 32/Charr. 16
- 11-157 Ben. 33
- 11-158 Ben. 34/Charr. 17
- 11-159 Ben. 35
- 11-160 Ben. 36/Charr. 18
- 11-161 Ben. 37
- 11-162 Ben. 38/Charr. 19
- 11-163 Ben. 39
- 11-164 Ben. 40/Charr. 20
- 11-165 Ben. 41
- 11-166 Ben. 42/Charr. 21
- 11-167 Ben. 43
- 11-168 Ben. 44/Charr. 22
- 11-169 Ben. 45
- 11-170 Ben. 46/Charr. 23
- 11-171 Ben. 47
- 11-172 Ben. 48/Charr. 24
- 11-173 Ben. 49
- 11-174 Ben. 50/Charr. 25
- 11-175 Ben. 51
- 11-176 Ben. 52/Charr. 26
- 11-177 Ben. 53
- 11-178 Ben. 54/Charr. 27
- 11-179 Ben. 55
- 11-180 Ben. 56/Charr. 28
- 11-181 Ben. 57
- 11-182 Ben. 58/Charr. 29
- 11-183 Ben. 59
- 11-184 Ben. 60/Charr. 30

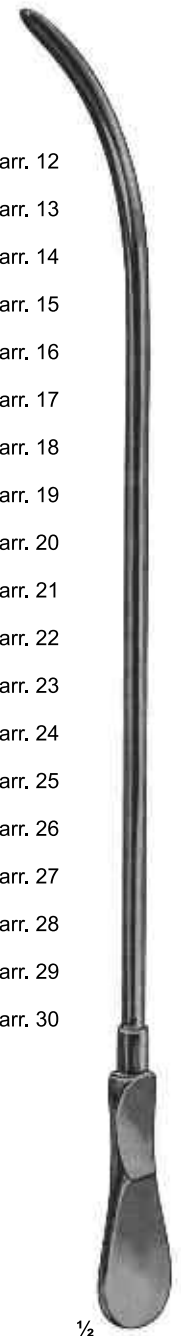

1/2

**11-148 - 184**  
Urethral bougies  
and dilating sounds  
255 mm

## Genito-Urinary Instruments & Circumcision Clamps

---



**11-185**  
**GUYON**  
Set of urethral bougies and dilating sounds,  
in metal case, with lift out rack and bottom  
rack, containing 21 urethral and dilating sounds.



**11-186**  
**WINKELMANN**  
**Circumcision Clamps**  
12 mm / 16 mm / 20 mm

# Trocars



**11-187**  
KLIMA ROSEGGER  
35 X 1,8 mm  
Sternal puncture needle

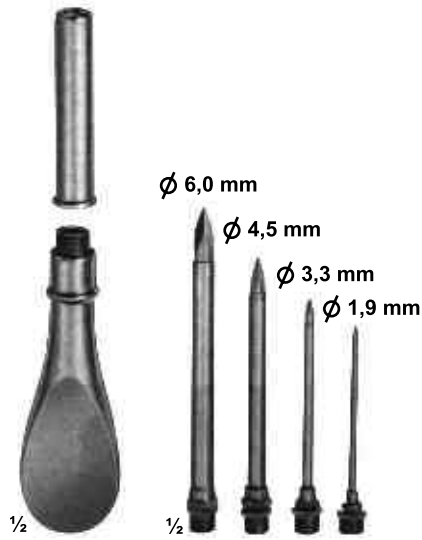

**11-188**  
Universal trocar  
with 4 tips



**11-189 - 193**  
Inside dime. Outside dime  
11-189 2,2 mm 3,0 mm  
11-190 3,0 mm 4,0 mm  
11-191 4,0 mm 5,0 mm  
11-192 5,0 mm 6,0 mm  
11-193 5,5 mm 6,5 mm  
for hydrocele and abdominal  
puncture



**11-194 - 197**  
Inside dime. Outside dime  
11-194 2,2 mm 3,0 mm  
11-195 3,0 mm 4,0 mm  
11-196 4,0 mm 5,0 mm  
11-197 5,0 mm 6,0 mm  
for abdominal puncture,  
with stop-cock and lateral  
drain

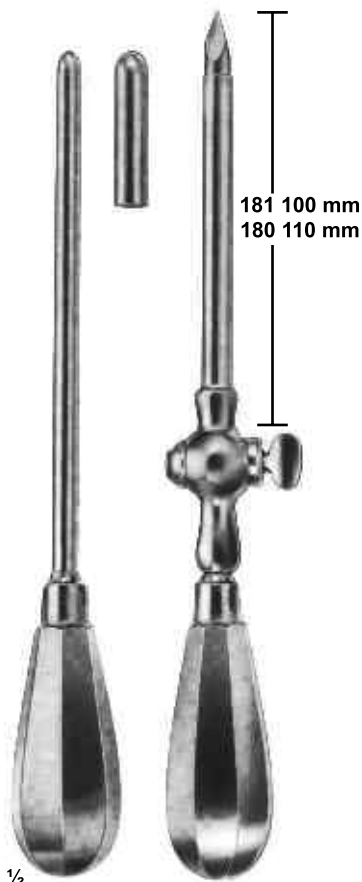

**11-198 - 199**  
Inside dime. Outside dime  
11-198 6,5 mm 8,0 mm  
11-199 9,0 mm 10,0 mm  
Empyema trocar

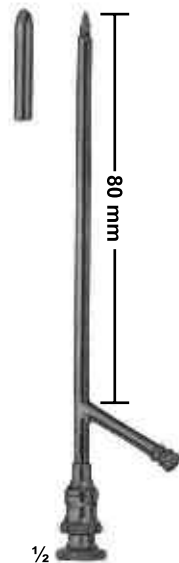

**11-200 - 203**  
Inside dime. Outside dime  
11-200 3,0 mm 4,0 mm  
11-201 3,6 mm 4,6 mm  
11-202 4,3 mm 5,3 mm  
11-203 5,0 mm 6,0 mm  
Gall bladder trocars



**11-204**  
PIERCE  
Antrum trocar  
4,0 mm



**11-205**  
COAKLEY  
Antrum trocar  
3,0 mm



# Vaginal specula

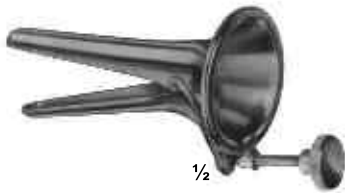

12-101  
COLLIN  
for children  
53 x 10 mm

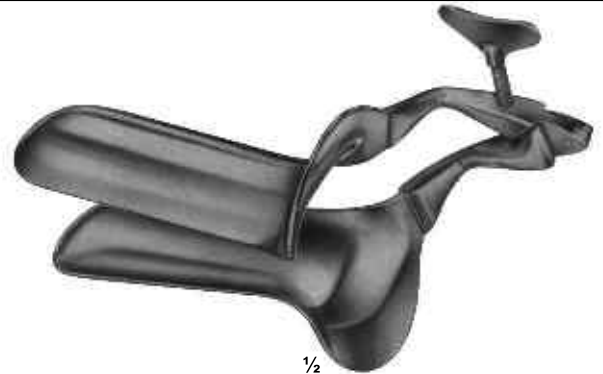

12-102 - 105  
COLLIN

12-102	100/90mm	28 mm
12-103	100/90mm	38 mm
12-104	105/95mm	35 mm
12-105	115/105mm	40 mm
Total length/working length		width



12-106  
COLLIN  
for virgins  
95/85 x 18 mm



12-107  
CUSCO  
for virgins  
75 x 17 mm



12-108  
CUSCO  
for virgins  
75 x 17 mm



12-109 - 111  
CUSCO

12-109	92X23-25 mm
12-110	100x25-27 mm
12-111	110x27-30 mm

# Vaginal Specula



1/2

**12-112 - 115**  
CUSCO  
STANDARD  
**12-112** 80X24 mm  
**12-113** 80X32 mm  
**12-114** 90X36 mm  
**12-115** 110X37 mm



1/2

**12-116 - 119**  
CUSCO  
**12-116** 80X24 mm  
**12-117** 80X32 mm  
**12-118** 90X36 mm  
**12-119** 110X37 mm



1/2

**12-120 - 122**  
CUSCO  
**12-120** 80X24 mm  
**12-121** 80X32 mm  
**12-122** 115X36 mm



1/2

**12-123 - 124**  
SEYFFERT  
**12-123** 100X24 mm  
**12-124** 110X32 mm  
230 mm



1/2

**12-125**  
SEMM  
for children  
and virgins  
180 mm

# Vaginal Specula, Sets, Upper & Lower Blades

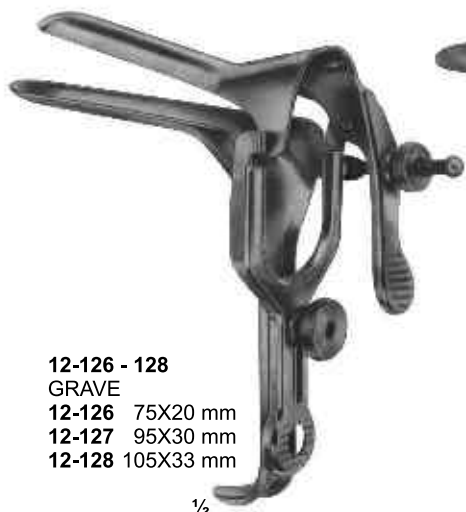

**12-126 - 128**  
GRAVE  
12-126 75X20 mm  
12-127 95X30 mm  
12-128 105X33 mm

1/2



**12-129 - 130**  
PEDERSON  
12-129 100X22 mm  
12-130 120X25 mm

1/2



**12-131 - 132**  
BRIESKY  
12-131 72X25 mm / 77X30 mm  
12-132 75X30 mm / 92X38 mm  
170 mm

1/2



1/2

**12-133 - 134**  
BREISKY  
12-133 100X22 mm  
77 X30 mm  
140 mm  
12-134 120X25 mm  
92 X38 mm  
170 mm



1/2

**12-135 - 137**  
SEIDL  
12-135 80X8 mm  
12-136 80X10 mm  
12-137 90X14 mm  
For children and infants  
170 mm



1/2

**12-138**  
KRISTELLER  
70X15 mm, ( 170 mm )  
For children



1/2

**12-139 - 141**  
SIMS  
12-139 70X26 mm  
75 X30 mm 125 mm  
12-140 75X30 mm  
80 X85 mm 150 mm  
11-141 80X36 mm  
90 X40 mm 175 mm

# Vaginal Specula-Sets, upper and lower blades



**12-142 - 146**  
**KRISTELLER**  
**12-142** 110X18 mm  
**12-143** 110X20 mm  
**12-144** 110X27 mm  
**12-145** 110X30 mm  
**12-146** 110X36 mm  
 220 mm

**12-147 - 150**  
**KRISTELLER**  
 Upper blades

**12-151 - 154**  
**KRISTELLER**  
 Lower blades

# Vaginal Specula-upper and lower blades

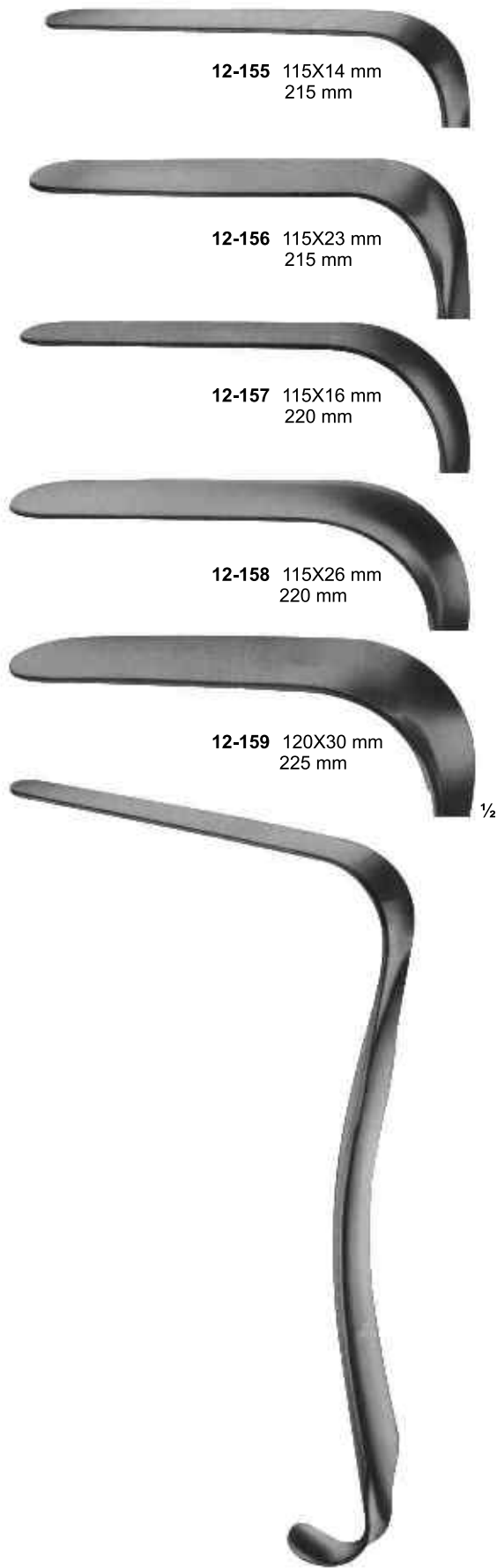

**12-155** 115X14 mm  
215 mm

**12-156** 115X23 mm  
215 mm

**12-157** 115X16 mm  
220 mm

**12-158** 115X26 mm  
220 mm

**12-159** 120X30 mm  
225 mm

**12-155 - 159**  
KRISTELLER  
Upper blades

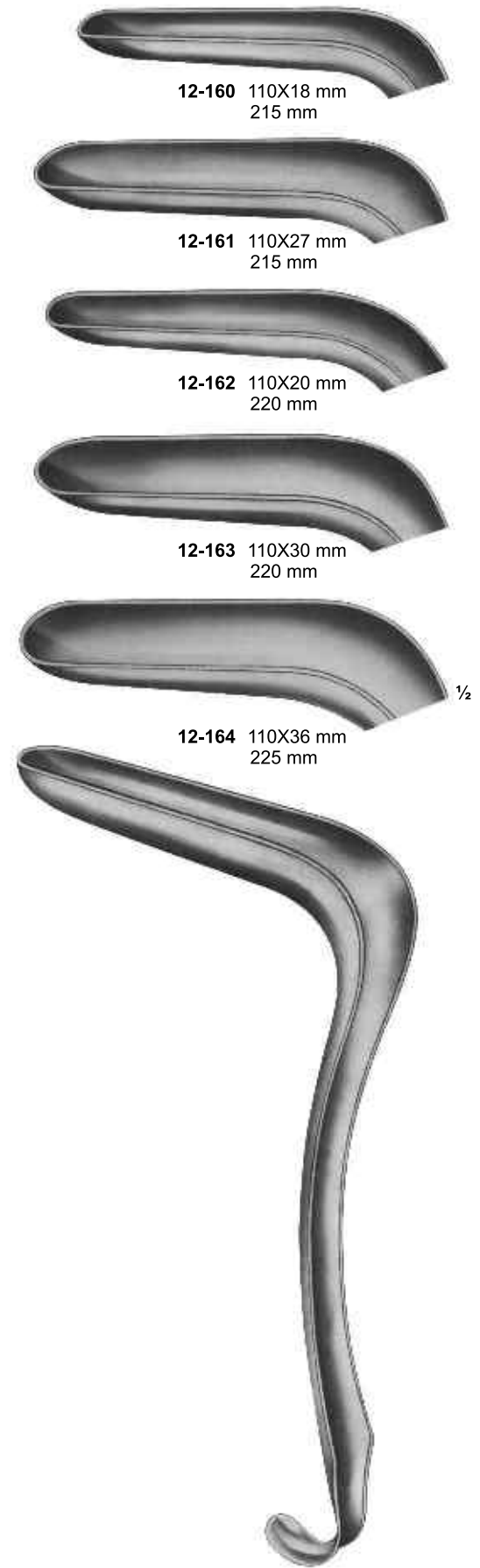

**12-160** 110X18 mm  
215 mm

**12-161** 110X27 mm  
215 mm

**12-162** 110X20 mm  
220 mm

**12-163** 110X30 mm  
220 mm

**12-164** 110X36 mm  
225 mm

**12-160 - 164**  
KRISTELLER  
Lower blades

# Vaginal Specula

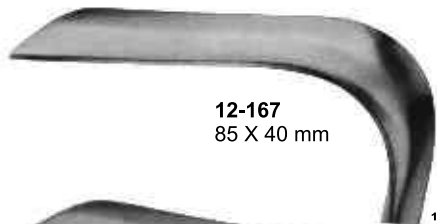

12-165 - 167  
KRISTELLER  
205 mm

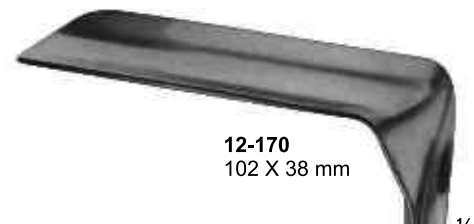
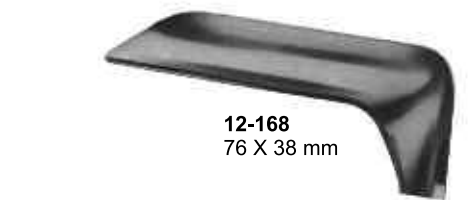

12-168 - 170  
JACKSON  
175 mm

# Vaginal Specula-for children & virgins / Vario Retractor



# Vaginal Specula-for children and virgins

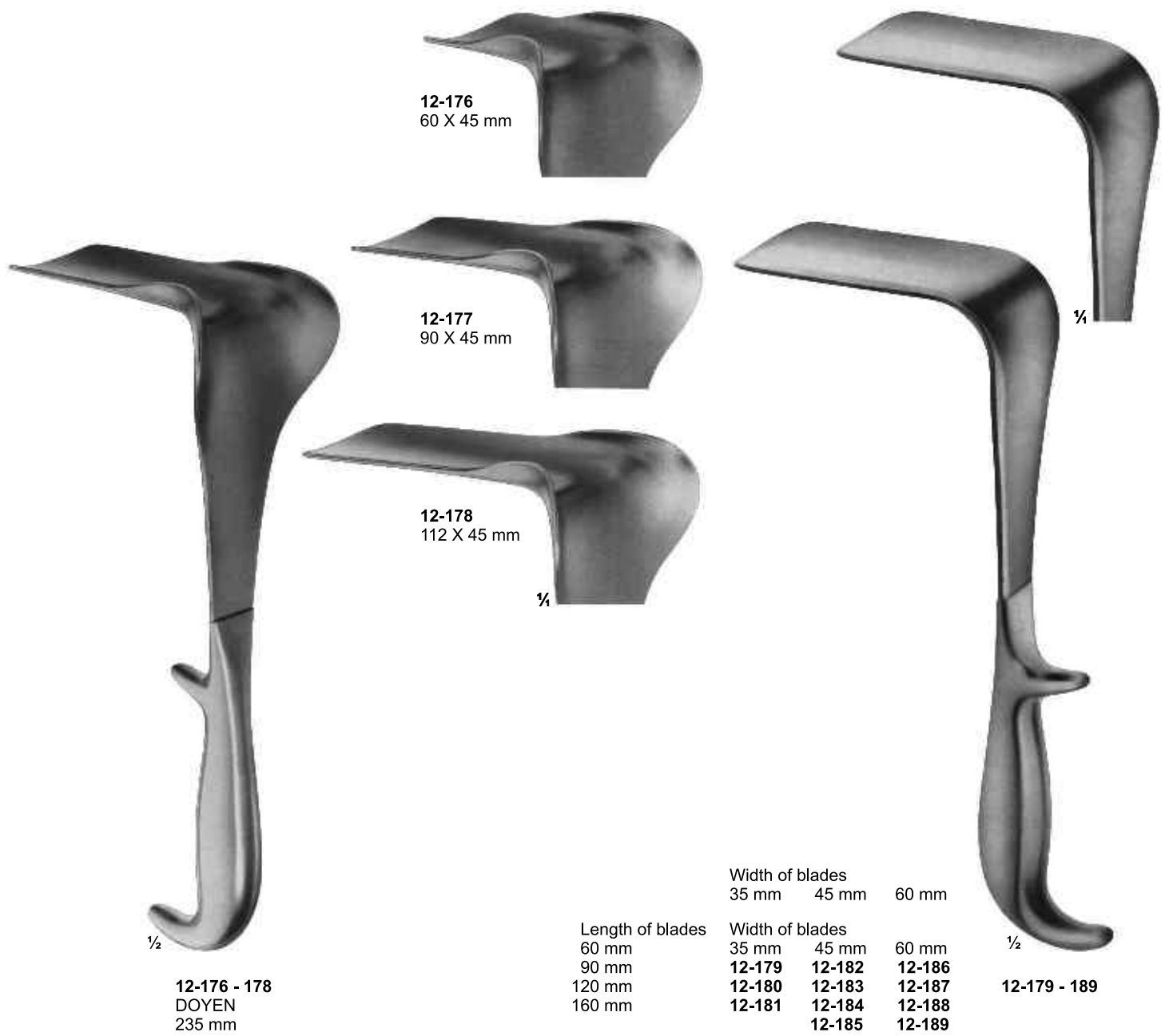



## Vaginal Specula / Retractors



1/2

**12-190 - 194**  
BREISKY  
WIENER MODELL/  
VIENNA PATTERN  
**12-190** 100 X 20 mm  
**12-191** 100 X 25 mm  
**12-192** 100 X 30 mm  
**12-193** 100 X 35 mm  
**12-194** 100 X 40 mm  
300 mm



1/2

**12-195 - 199**  
BREISKY  
WIENER MODELL/  
VIENNA PATTERN  
**12-195** 130 X 20 mm  
**12-196** 130 X 25 mm  
**12-197** 130 X 30 mm  
**12-198** 130 X 35 mm  
**12-199** 130 X 40 mm  
320 mm



1/2

**12-200 - 201**  
WEISSBARTH  
**12-200** 80 X 28 mm  
**12-201** 85 X 42 mm  
210 mm



1/2

**12-202**  
DOYEN  
lateral speculum  
80 x 30 mm  
250 mm

# Vaginal & Wound Retractor / Vaginal Specula



**12-203**  
SIMON  
115 X 22 mm  
275 mm

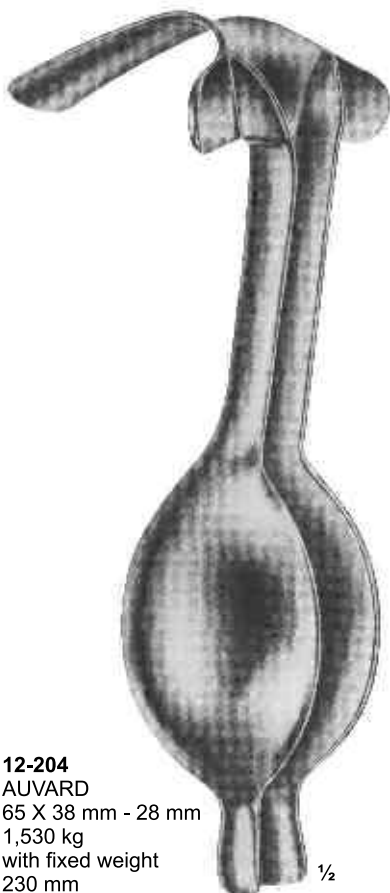

**12-204**  
AUVARD  
65 X 38 mm - 28 mm  
1,530 kg  
with fixed weight  
230 mm



**12-205 - 206**  
AUVARD  
**12-205** 75 X 42 mm  
( 40 mm )  
**12-206** 105 X 43 mm  
( 40 mm )  
with detachable wight  
230 mm



**12-207**  
MARTIN  
with hook shaped  
handle for hanging  
in weights  
270 mm

# Vaginal Speculas

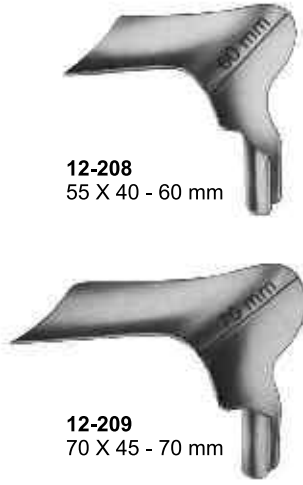

# Vaginal Retractors



1/2  
**12-221**  
JOLL (FRIEDMAN)  
155 mm



1/4  
1/2  
**12-222**  
RICHTER  
170 mm

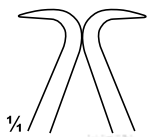

1/4  
1/2  
**12-223**  
GELPI  
135 mm

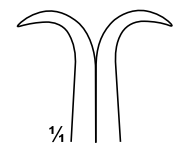

1/4  
1/2  
**12-224**  
GELPI  
175 mm

# Uterine Dilators



1/2

**13-101 - 143**  
HEGAR  
with very conical point  
185 mm

<b>13-101</b>	1	mm	<b>13-123</b>	23	mm
<b>13-102</b>	2	mm	<b>13-124</b>	24	mm
<b>13-103</b>	3	mm	<b>13-125</b>	25	mm
<b>13-104</b>	4	mm	<b>13-126</b>	26	mm
<b>13-105</b>	5	mm	<b>13-127</b>	1	1/2mm
<b>13-106</b>	6	mm	<b>13-128</b>	2	1/2mm
<b>13-107</b>	7	mm	<b>13-129</b>	3	1/2mm
<b>13-108</b>	8	mm	<b>13-130</b>	4	1/2mm
<b>13-109</b>	9	mm	<b>13-131</b>	5	1/2mm
<b>13-110</b>	10	mm	<b>13-132</b>	6	1/2mm
<b>13-111</b>	11	mm	<b>13-133</b>	7	1/2mm
<b>13-112</b>	12	mm	<b>13-134</b>	8	1/2mm
<b>13-113</b>	13	mm	<b>13-135</b>	9	1/2mm
<b>13-114</b>	14	mm	<b>13-136</b>	10	1/2mm
<b>13-115</b>	15	mm	<b>13-137</b>	11	1/2mm
<b>13-116</b>	16	mm	<b>13-138</b>	12	1/2mm
<b>13-117</b>	17	mm	<b>13-139</b>	13	1/2mm
<b>13-118</b>	18	mm	<b>13-140</b>	14	1/2mm
<b>13-119</b>	19	mm	<b>13-141</b>	15	1/2mm
<b>13-120</b>	20	mm	<b>13-142</b>	16	1/2mm
<b>13-121</b>	21	mm	<b>13-143</b>	17	1/2mm
<b>13-122</b>	22	mm			



1/2

**13-144 - 152**  
HEGAR  
205 mm

<b>13-144</b>	1+2	mm
<b>13-145</b>	3+4	mm
<b>13-146</b>	5+6	mm
<b>13-147</b>	7+8	mm
<b>13-148</b>	9+10	mm
<b>13-149</b>	11+12	mm
<b>13-150</b>	13+14	mm
<b>13-151</b>	15+16	mm
<b>13-152</b>	17+18	mm

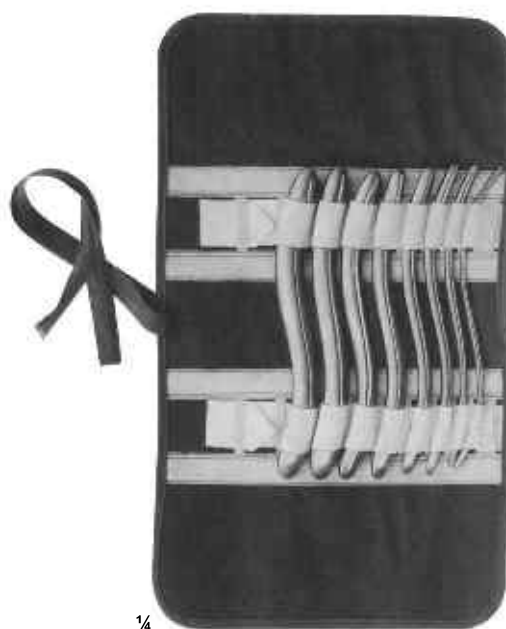

1/4

**13-153**  
HEGAR  
Uterine dilator set, in canvas  
roll with 8 dilators.

## Uterine Dilators - Complete Sets



**13-154**  
HEGAR  
Dilator set consisting of:  
14 Dilators,  
1 Rack for dilators ( 4 - 12 mm )  
1 Rack for Dilators ( 13 - 17 mm )  
1 Metal case only,  
with hinged lid, stainless 200 X 100 X 35 mm

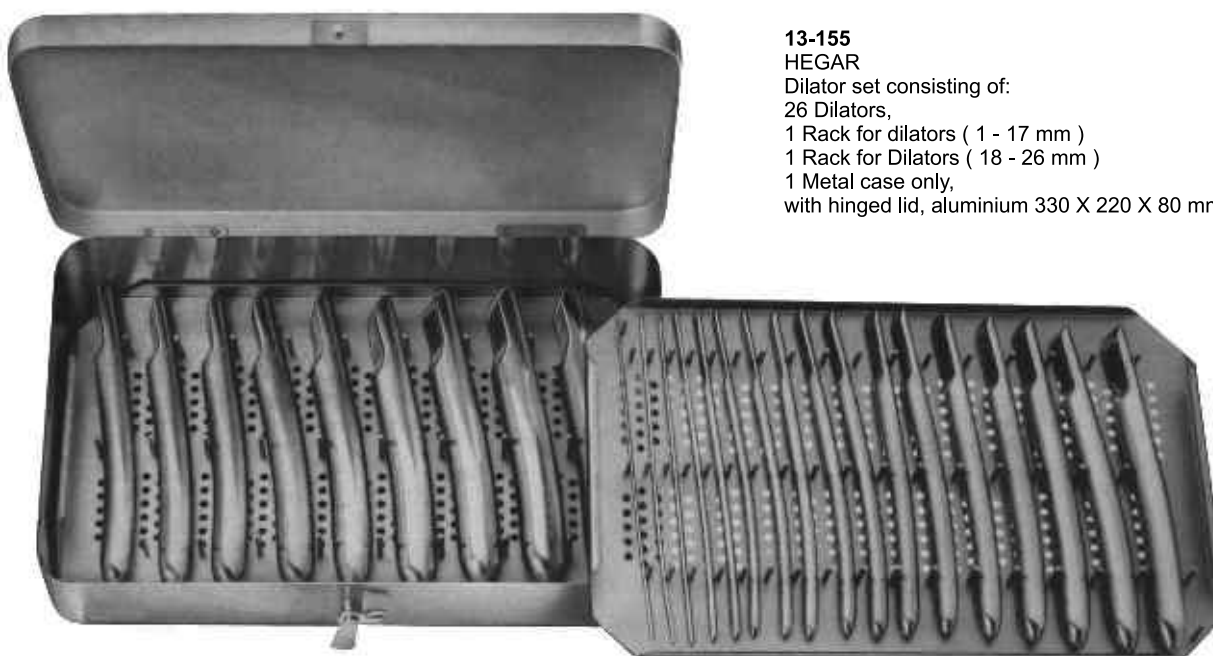

**13-155**  
HEGAR  
Dilator set consisting of:  
26 Dilators,  
1 Rack for dilators ( 1 - 17 mm )  
1 Rack for Dilators ( 18 - 26 mm )  
1 Metal case only,  
with hinged lid, aluminium 330 X 220 X 80 mm

# Endospecula For Cervix

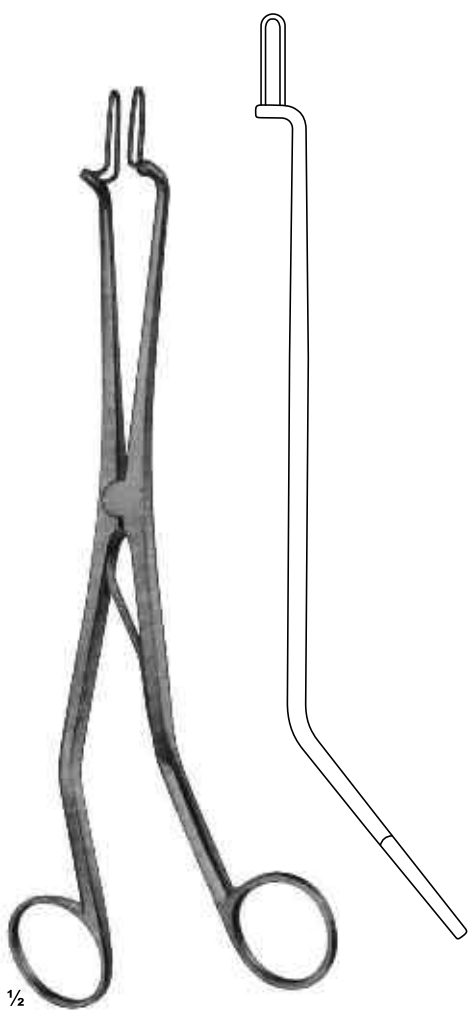

**13-156**  
KOGAN  
Endospecula for cervix  
and urethra, without ratchet  
240 mm

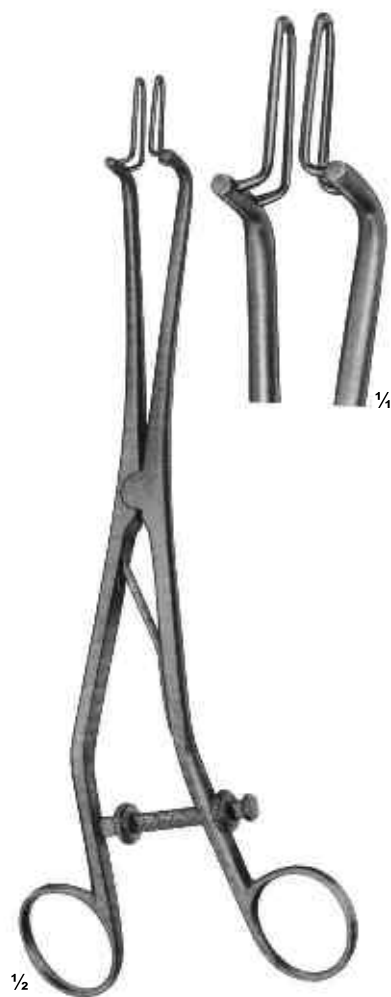

**13-157**  
KOGAN  
Endospecula for cervix  
and urethra, with  
scale-ratchet and fixing screws  
240 mm

# Uterine Probes



**14-101**  
MAYO  
biegsam malleable  
330 mm



**14-102**  
SIMS  
biegsam malleable  
330 mm



**14-103**  
MARTIN  
330 mm



**14-104**  
SIMPSON  
malleable  
silver-plated  
290 mm



**14-105**  
BRAUN  
Uterine  
depressor  
270 mm



**14-106**  
Cotton  
applicator  
270 mm



# Uterine Dressing Forceps

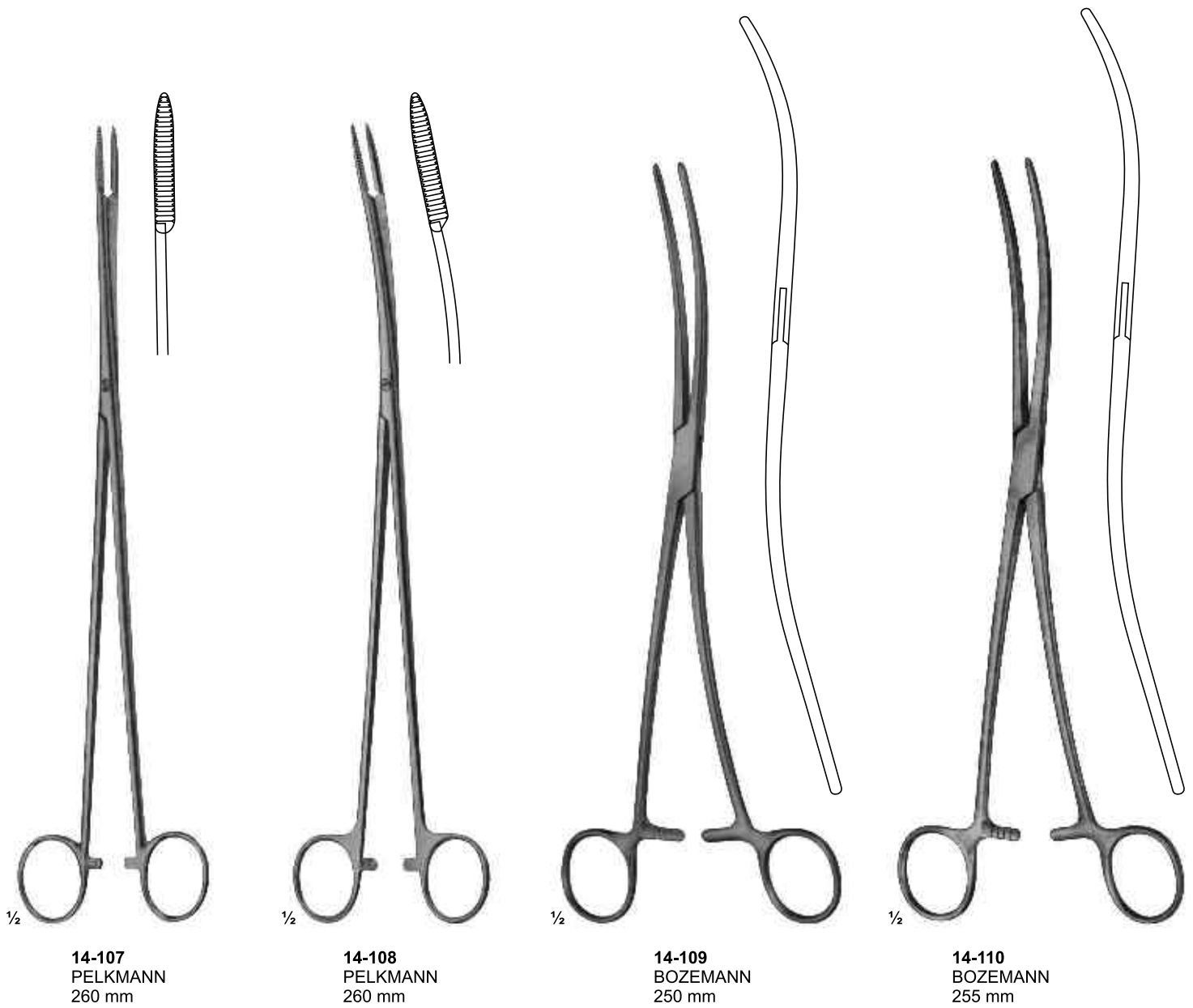

# Uterine Dressing Forceps

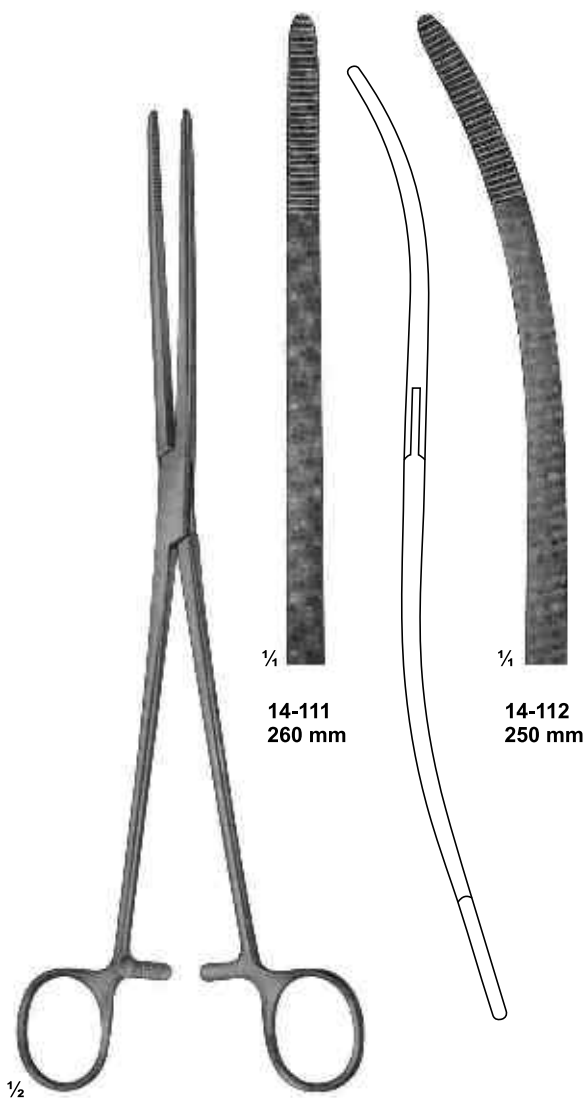

14-111 - 112  
BOZEMANN

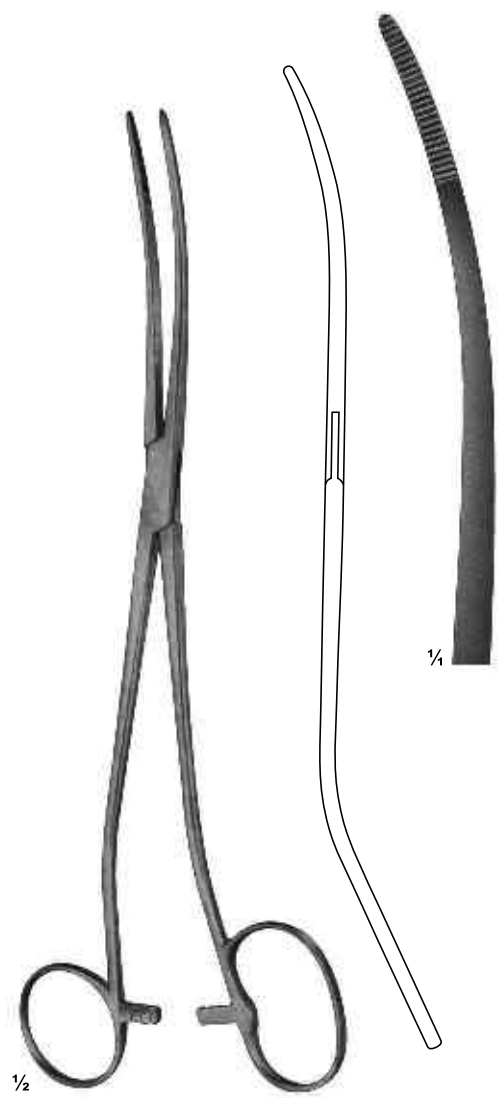

14-113  
BOZEMANN-DOUGLAS  
260 mm

# Uterine Tenaculum Forceps

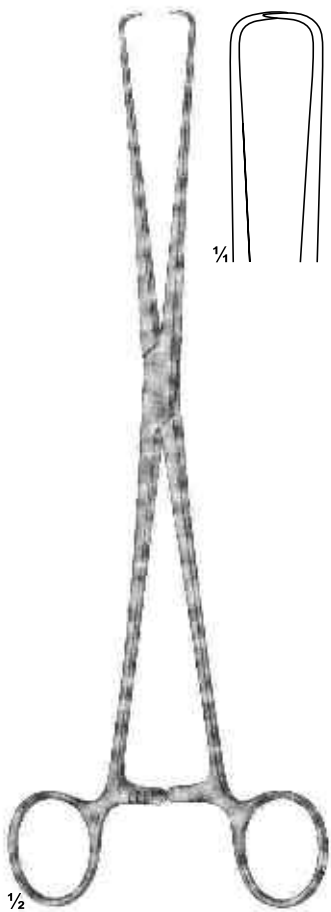

**14-114**  
BRAUN  
slender type  
250 mm

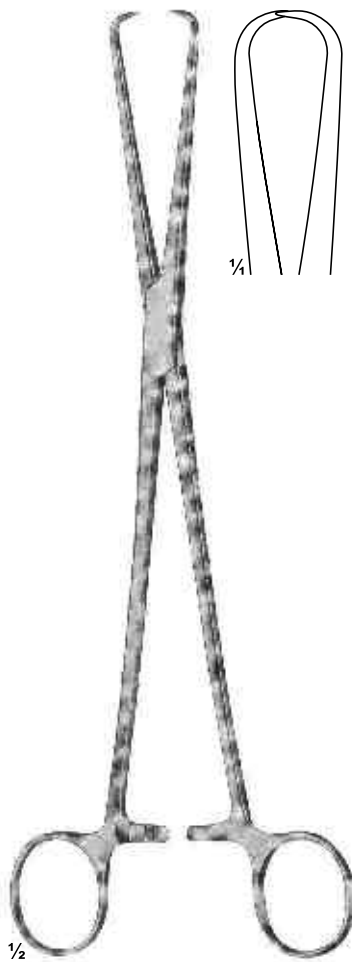

**14-115**  
SCHRODER  
250 mm

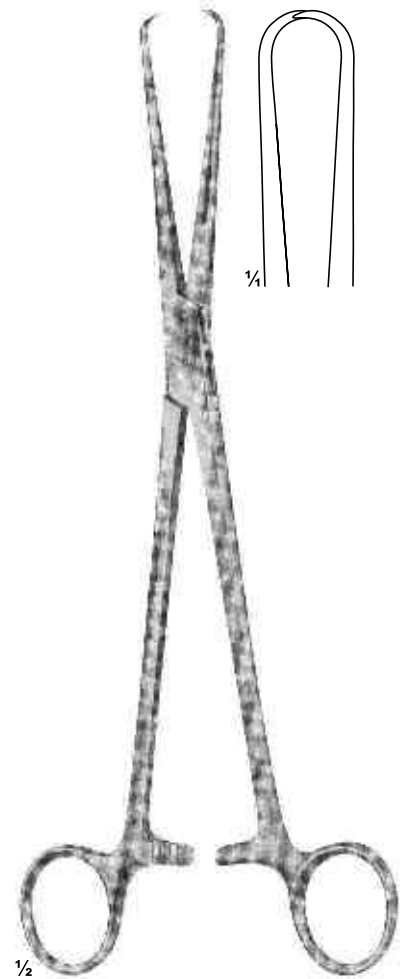

**14-116**  
POZZI  
heavy type  
255 mm

# Uterine Tenaculum Forceps



**14-117**  
265 mm

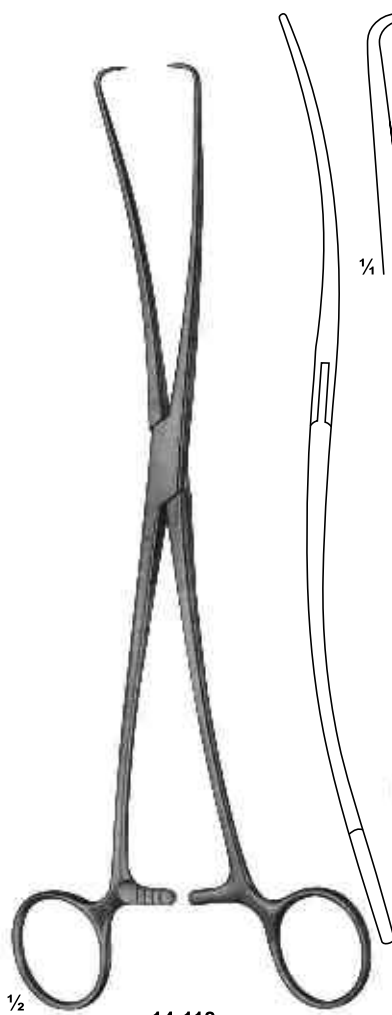
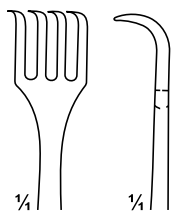

**14-118**  
DUPLAY  
250 mm

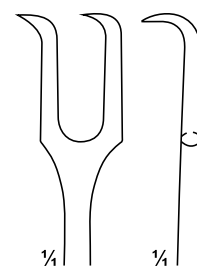
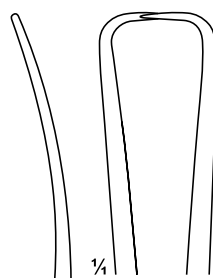

**14-119**  
LAHEY  
155 mm

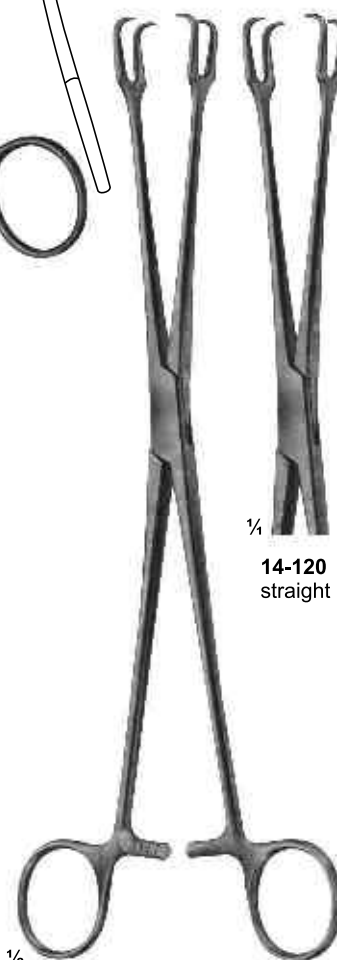

**14-120**  
straight



**14-121**  
curved  
on flat



**14-122**  
curved  
sideways

**14-120 - 122**  
SCHRODER  
250 mm

# Uterine Tenaculum Forceps

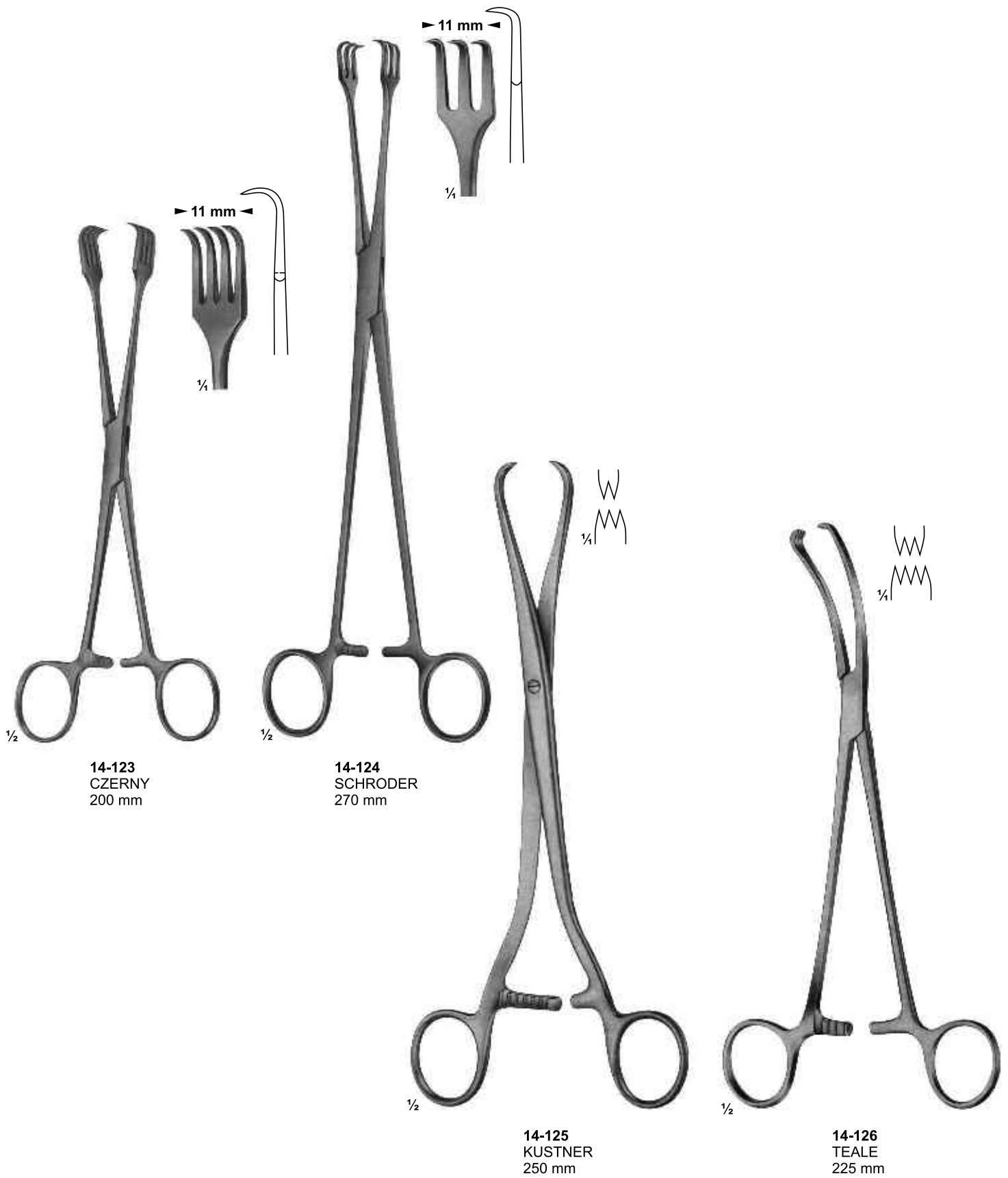

# Uterine Tenaculum Forceps

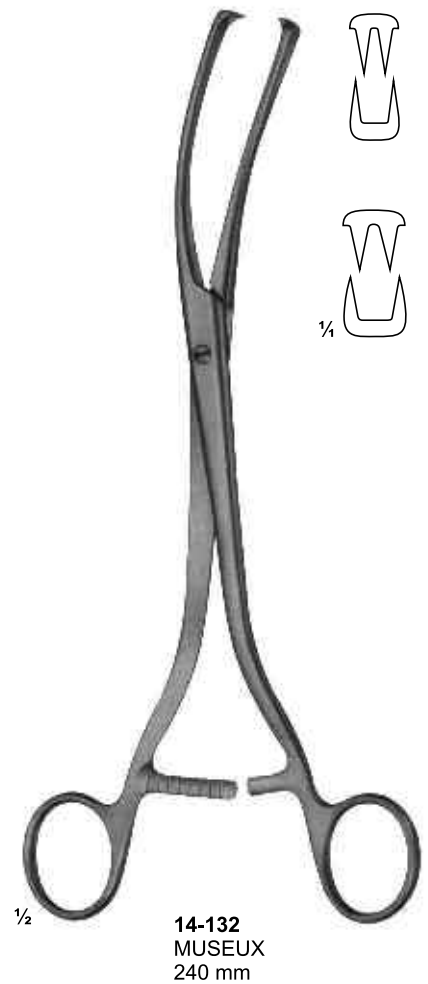
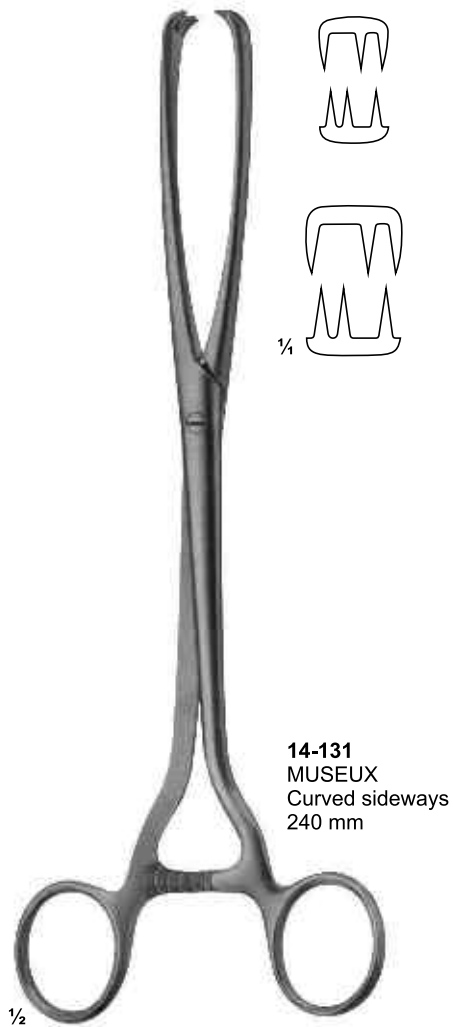
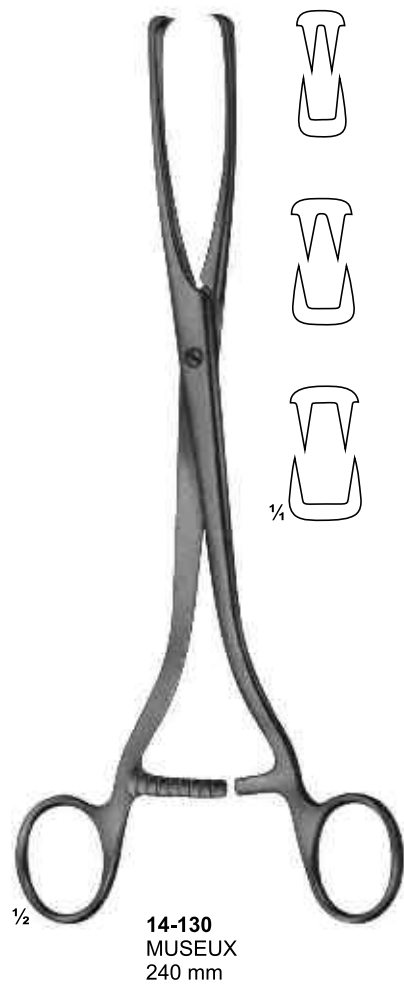

# Polypus-and Ovum Forceps

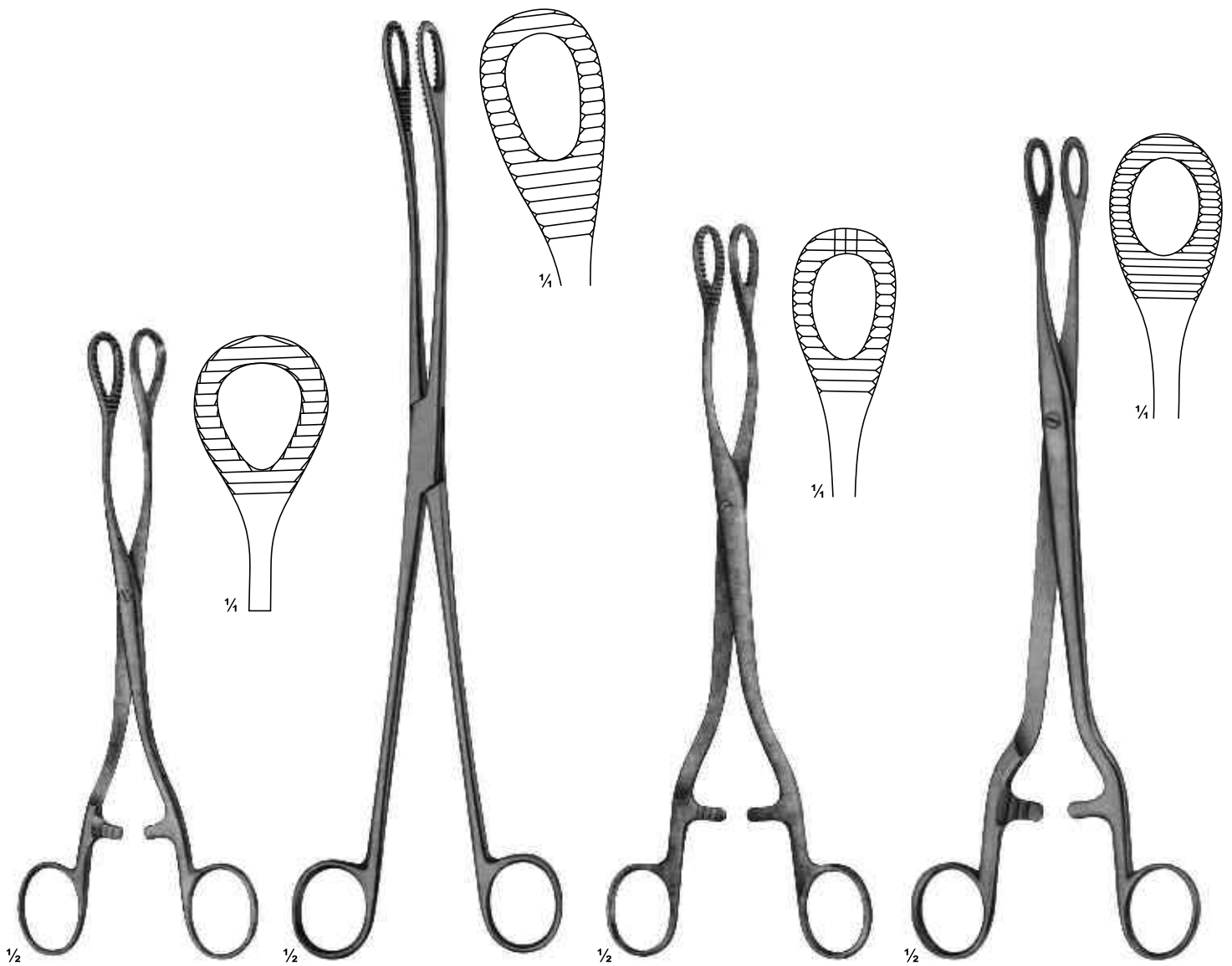

**14-133**  
HEYWOOD-SMITH  
200 mm

**14-134**  
KELLY  
320 mm

**14-135**  
HEYWOOD-SMITH  
250 mm

**14-136**  
NOTO  
280 mm

# Polypus and Ovum Forceps



¼



¼



¼

14-138

14-139



¼



½

14-137  
DOYEN  
185 mm



½

14-138 - 139  
250 mm 270 mm



½

14-140  
BUMM  
280 mm



## Uterine Elevating Forceps

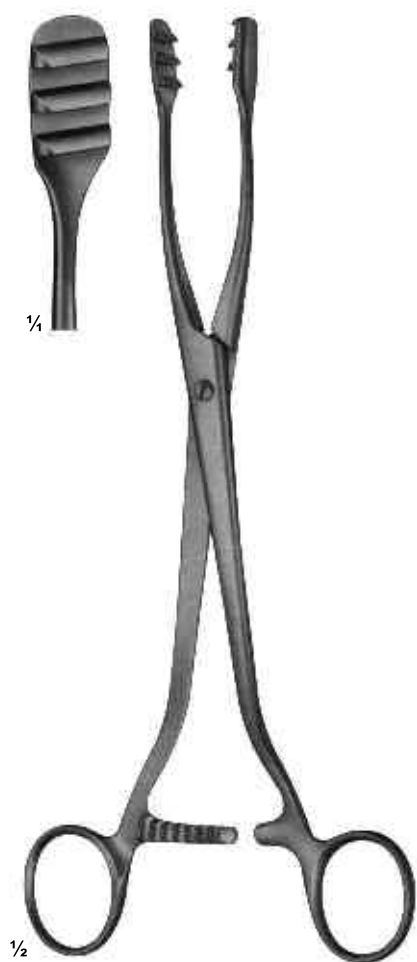

**14-141**  
COLLIN  
250 mm



**14-142**  
COLLIN  
285 mm



**14-143**  
DARTIGUES  
255 mm

## Uterine Elevating Forceps



**14-144**  
**SOMMER**  
235 mm



**14-145**  
**STRASSMANN**  
260 mm

# Uterine Elevating Forceps

With movable jaws



1/2

14-146  
COLLIN  
265 mm

With movable jaws



1/2

14-147  
260 mm

# Myoma Instruments



**14-148**  
SEGOND  
Myomatome  
270 mm



**14-149**  
DOYEN  
Myoma screw  
150 mm



**14-150**  
DOYEN  
Myoma screw  
190 mm

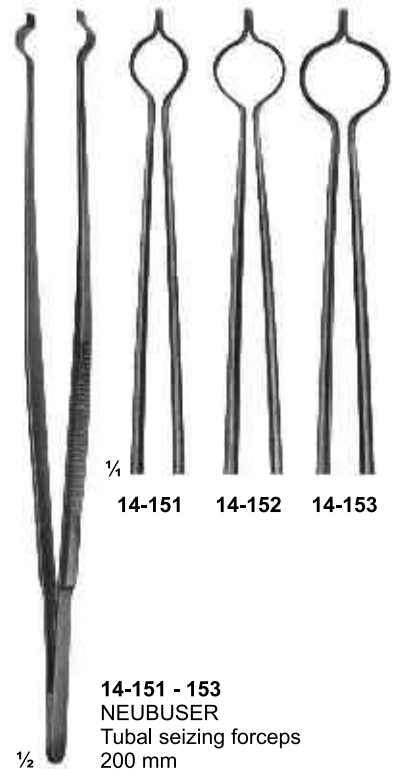

**14-151**   **14-152**   **14-153**

**14-151 - 153**  
NEUBUSER  
Tubal seizing forceps  
200 mm



**14-154**  
Splint guide  
with thread



**14-155**  
Splint guide with  
round handle  
180 mm



**14-156**  
Angled glass rods  
Set . 3 pieces



**14-157**  
Silicon operating pad  
pre-cut

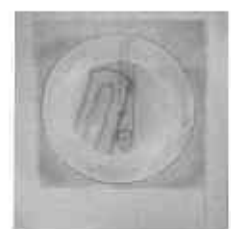

**14-158**  
Polyethylen splint material  
soft-sterile  
0.45 mm

# Biopsy Curettes

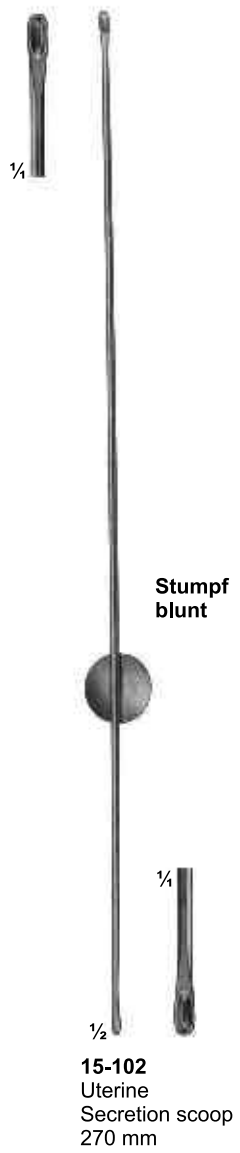

# Biopsy Forceps

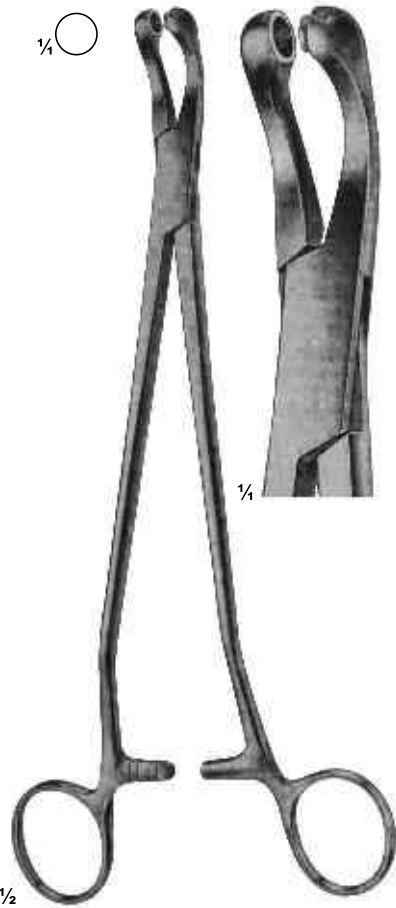

**15-105**  
THOMS-GAYLOR  
240 mm



**15-106**  
SCHUBERT  
260 mm

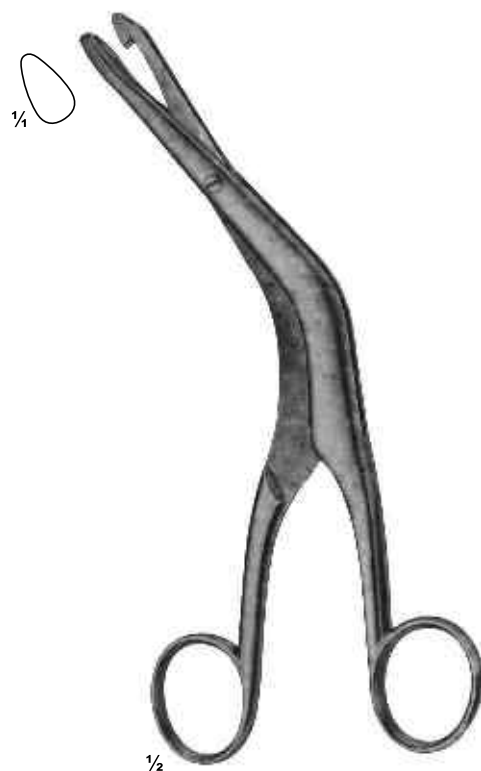

**15-107**  
FAURE  
210 mm

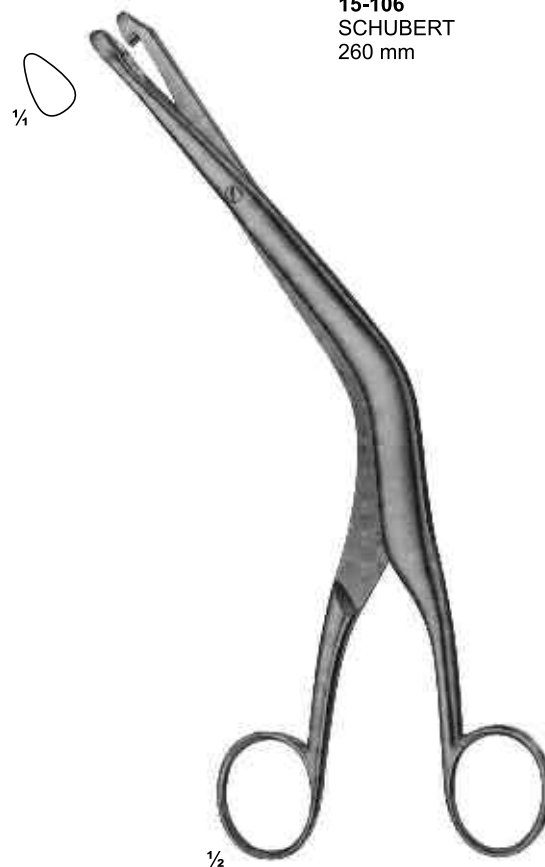

**15-108**  
FAURE  
240 mm

# Biopsy Forceps

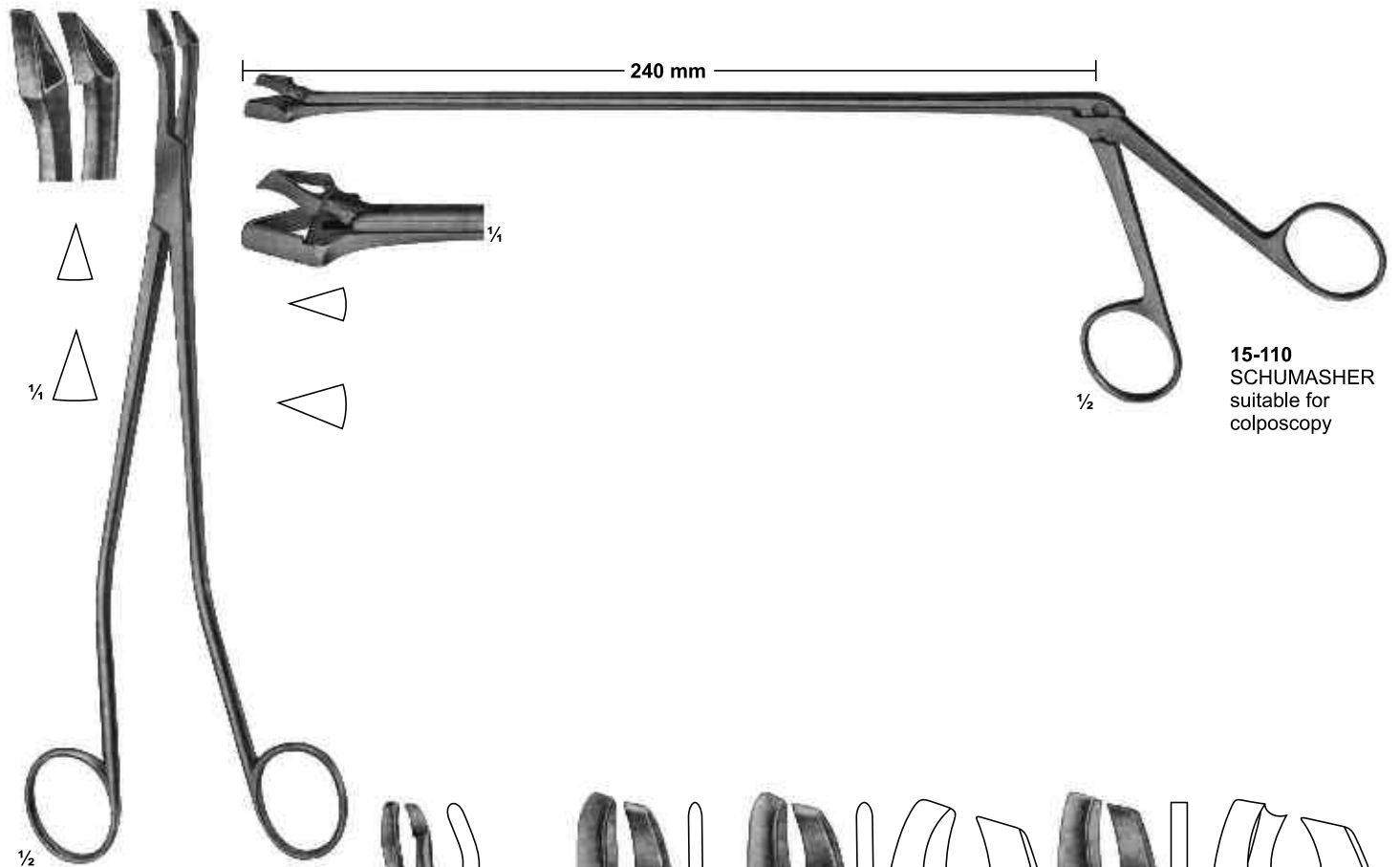

**15-110**  
SCHUMASHER  
suitable for  
colposcopy

**15-109**  
SCHUMASHER  
240mm

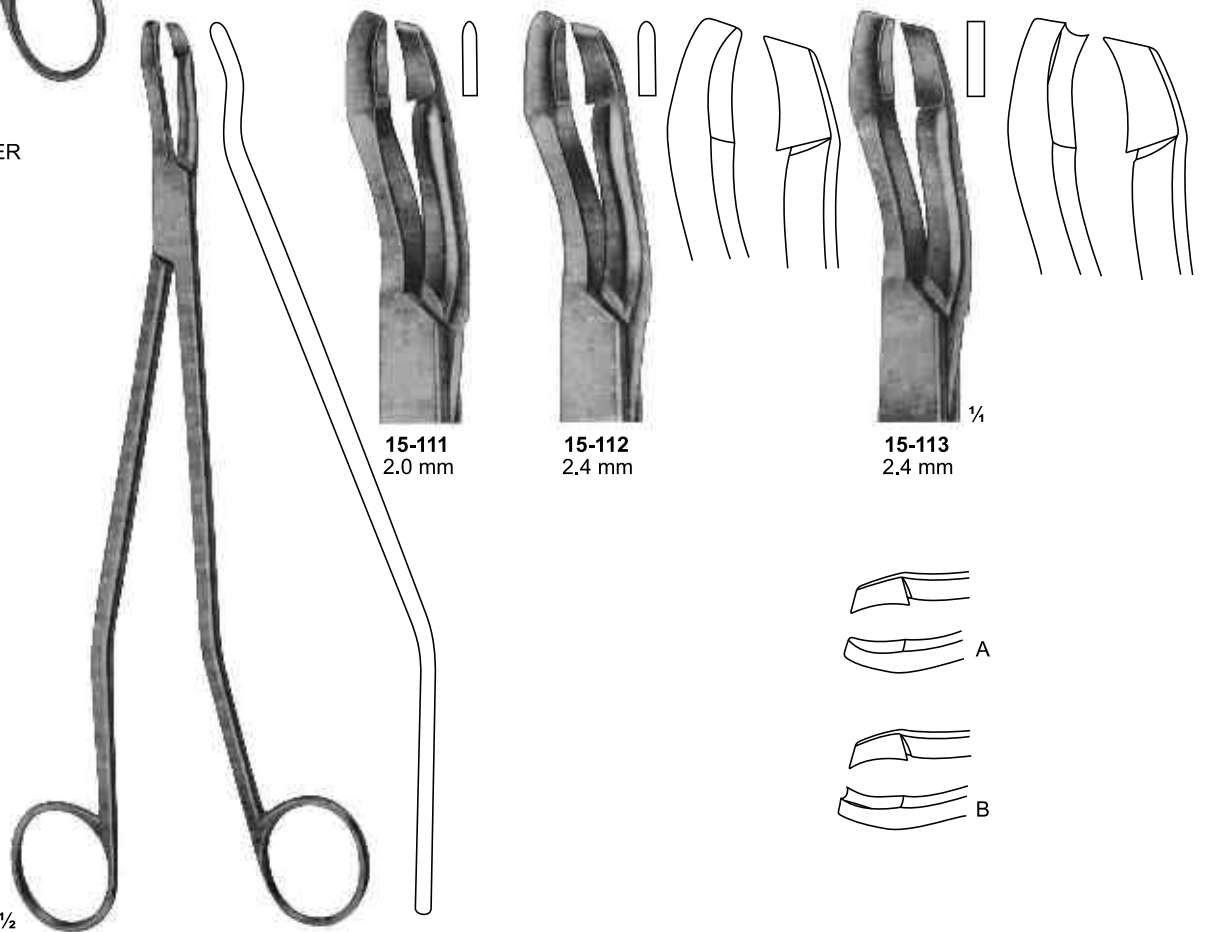

**15-111**  
2.0 mm

**15-112**  
2.4 mm

**15-113**  
2.4 mm

**15-111 - 113**  
SEIDL DBP  
Biopsy forceps, bayonet shaped  
for portio, vagina and vulva  
240mm

# Biopsy Forceps

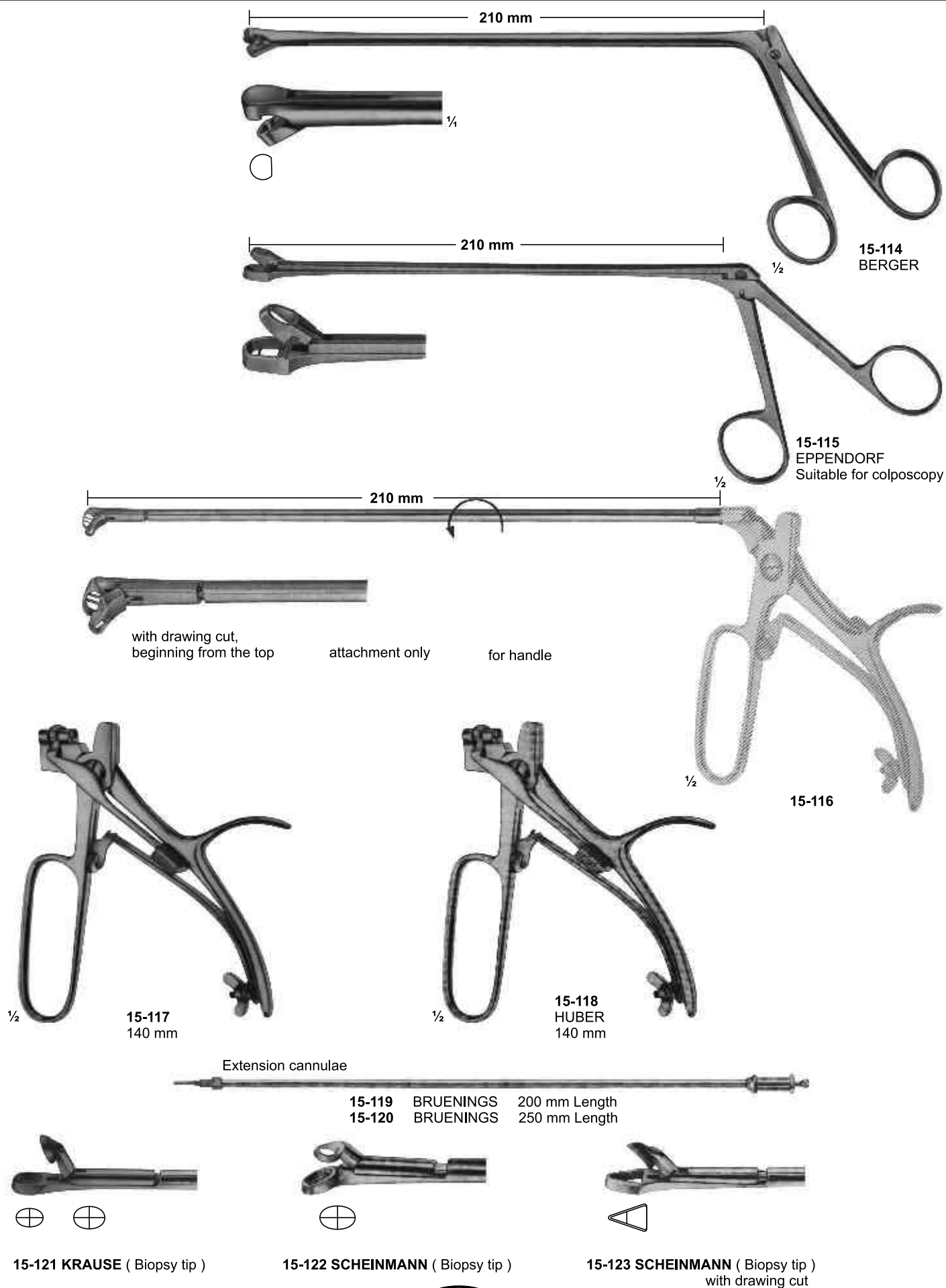



# Uterine Scoops

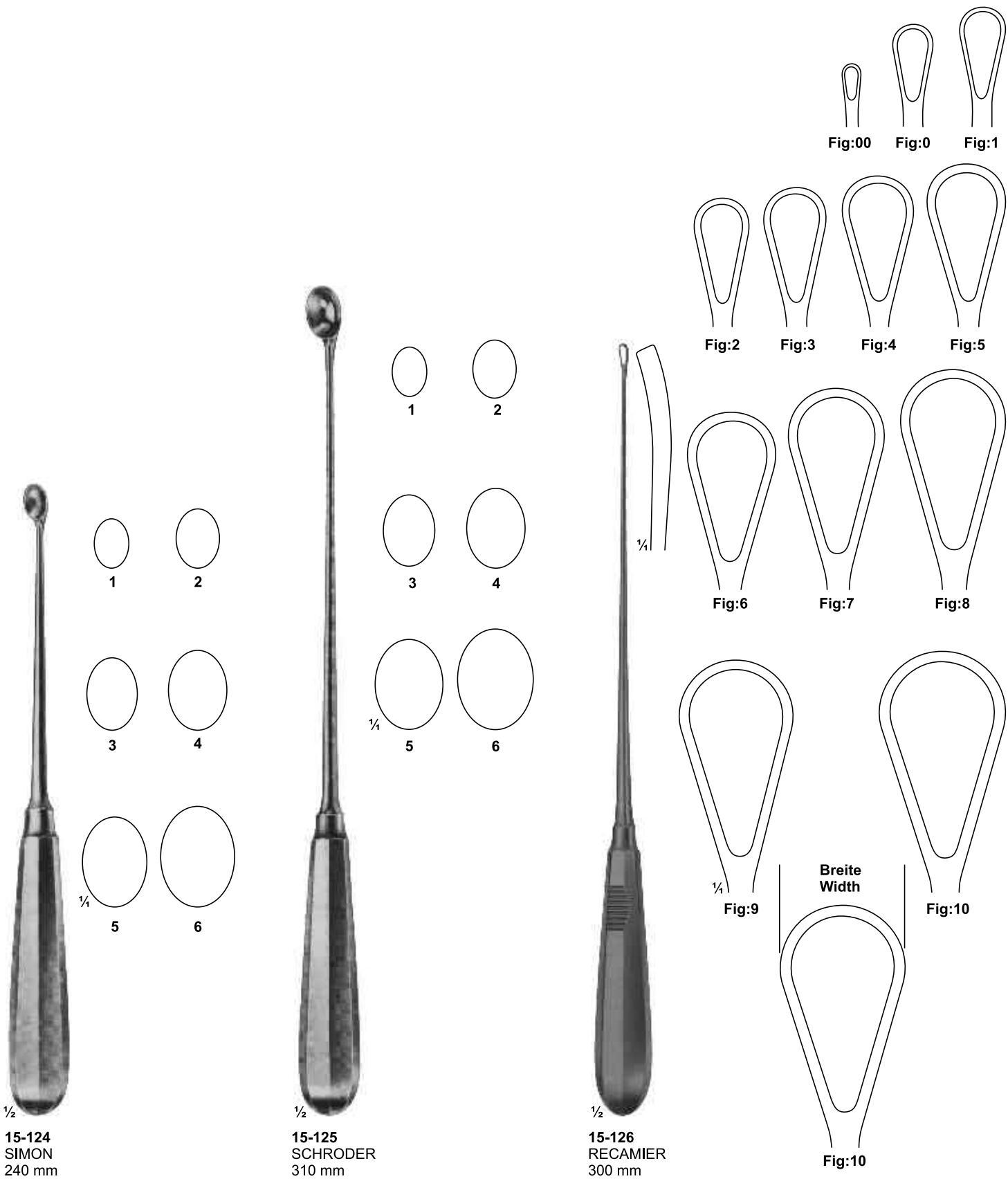

1/2  
15-124  
SIMON  
240 mm

1/2  
15-125  
SCHRODER  
310 mm

1/2  
15-126  
RECAMIER  
300 mm

# Uterine Curettes

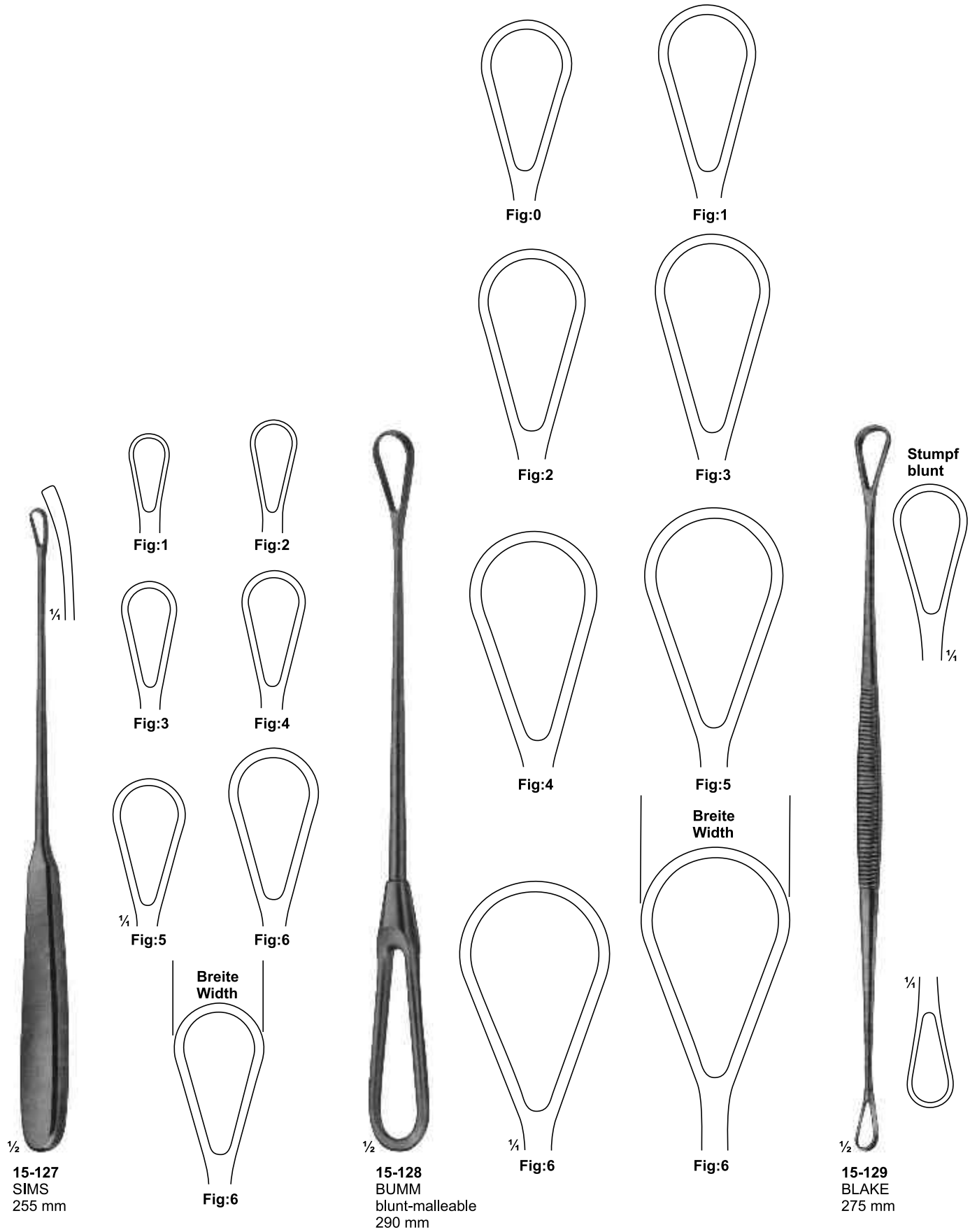

# Placenta-and Ovum Curettes



1/2  
**15-130**  
**COLLIN**  
 300 mm



1/2  
**15-131**  
**RECAMIER**  
 blunt-rigid  
 360 mm

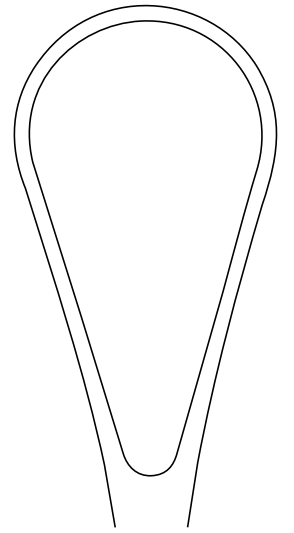

**Fig:1**

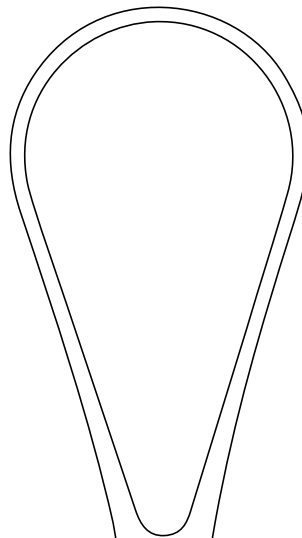

1/4

**Fig:2**



1/2  
**15-132**  
**BUMM**  
 310 mm

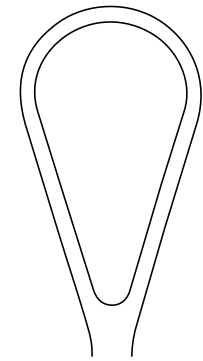

**Fig:1**

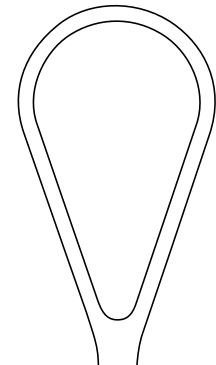

**Fig:2**

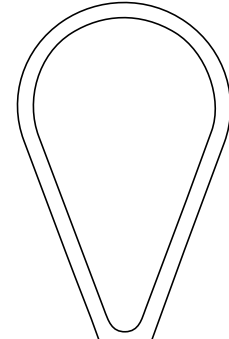

1/4

**Fig:3**

# Vacuum Currettes

## 15-133 - 138

Suction currettes, stainless steel, fitting hose connection.

Working tips are smoothly rounded of, therefore no danger of perforation.

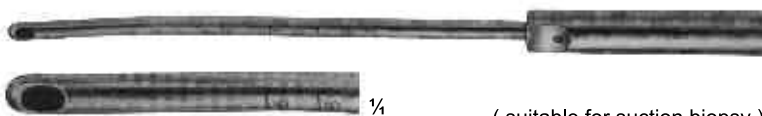

( suitable for suction biopsy )

15-133: diam 4 mm

15-134: diam 6 mm

15-135: diam 8 mm

15-136: diam 10 mm

15-137: diam 12 mm

15-138: diam 14 mm

## 15-139

Hose connection inside diam. 11 mm curved stainless steel.



## 15-140

The new connection between suction curette and hose connection, Guarantees quick changing and free turning of the suction currettes on the hose connection.

## 15-141

Transparent suction hose 1.8 m long, inside diam 11 mm, outside diam 16.5 mm can be sterilized in an autoclave at 1 bar overpressure ( 120 C )



## 15-142

Strainer for tissues, plastic, for single use only, to be used for histopathological examination.

# Gynaecological Instruments

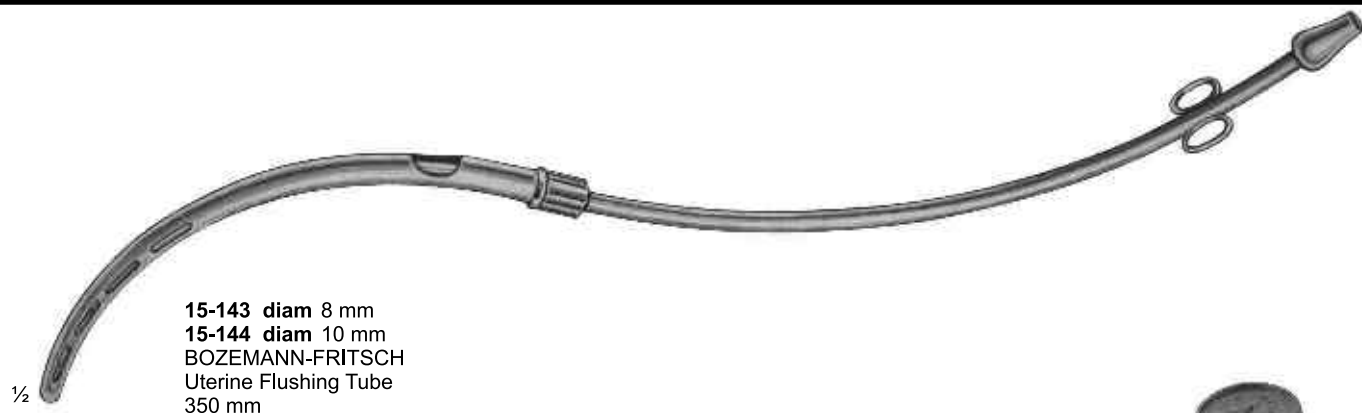

15-143 diam 8 mm  
 15-144 diam 10 mm  
 BOZEMANN-FRITSCH  
 Uterine Flushing Tube  
 350 mm

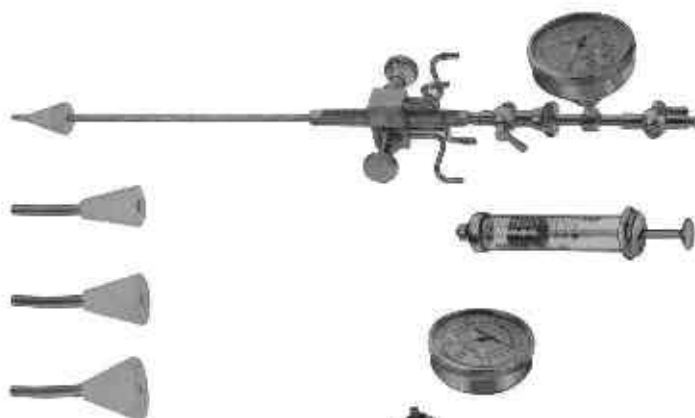

15-145  
 SCHULZE  
 Salpingograph, for utero-salpingography  
 in wooden case, consisting of:  
 Manometer, Connection, Uterine canulla  
 with tap, Cone S.M.L.,  
 Record Syringe 10 cc, Luer lock mount.



15-146  
 SCHULZE  
 Salpingograph, equipment  
 without manometer.



# Obstetrics-Pelvimeters

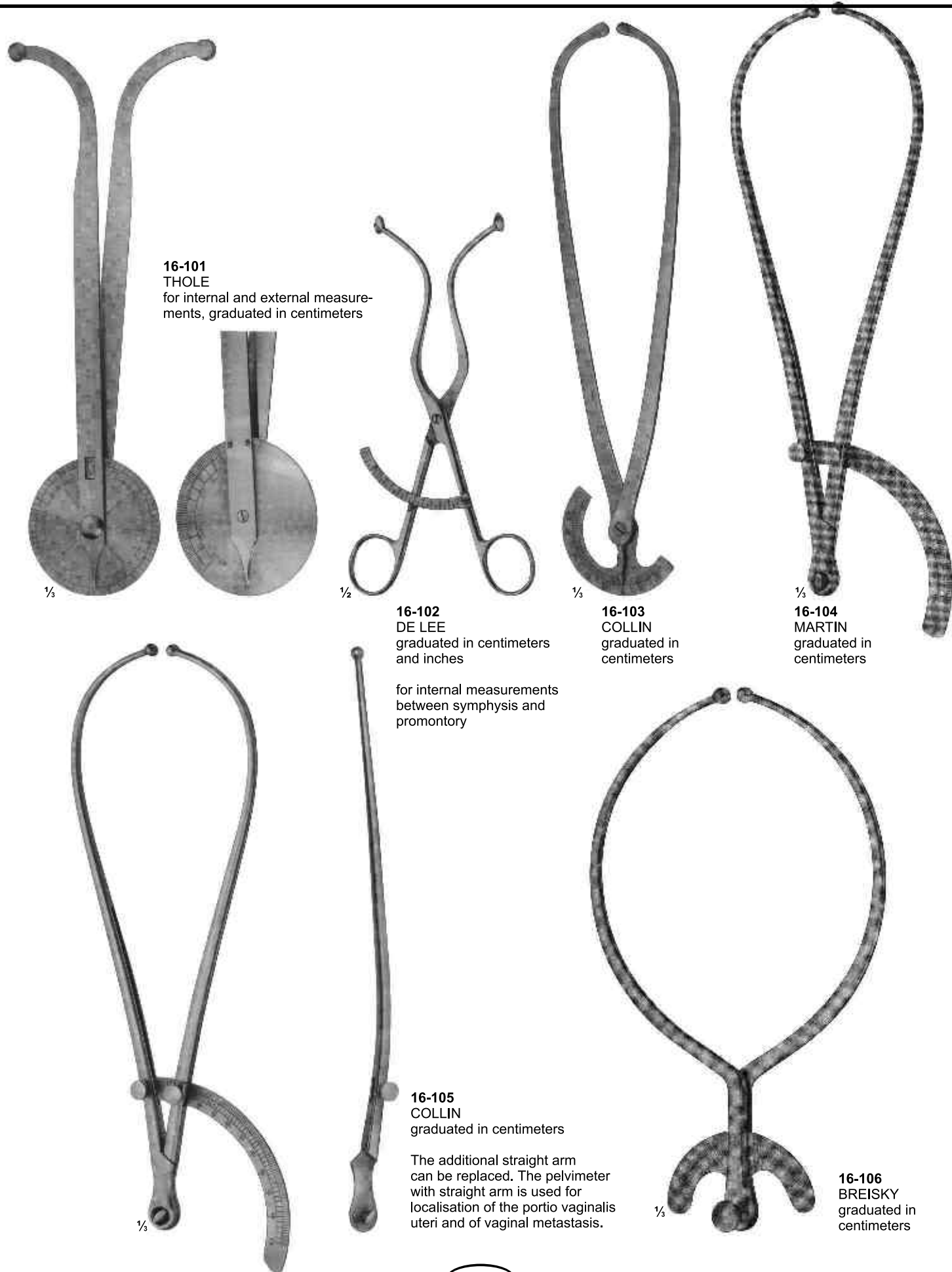

**16-101**  
**THOLE**  
for internal and external measurements, graduated in centimeters

1/8

1/2

1/8

1/8

**16-102**  
**DE LEE**  
graduated in centimeters and inches

**16-103**  
**COLLIN**  
graduated in centimeters

**16-104**  
**MARTIN**  
graduated in centimeters

for internal measurements between symphysis and promontory

**16-105**  
**COLLIN**  
graduated in centimeters

The additional straight arm can be replaced. The pelvimeter with straight arm is used for localisation of the portio vaginalis uteri and of vaginal metastasis.

**16-106**  
**BREISKY**  
graduated in centimeters

1/8

1/8

# Obstetrics-Pelvimeters

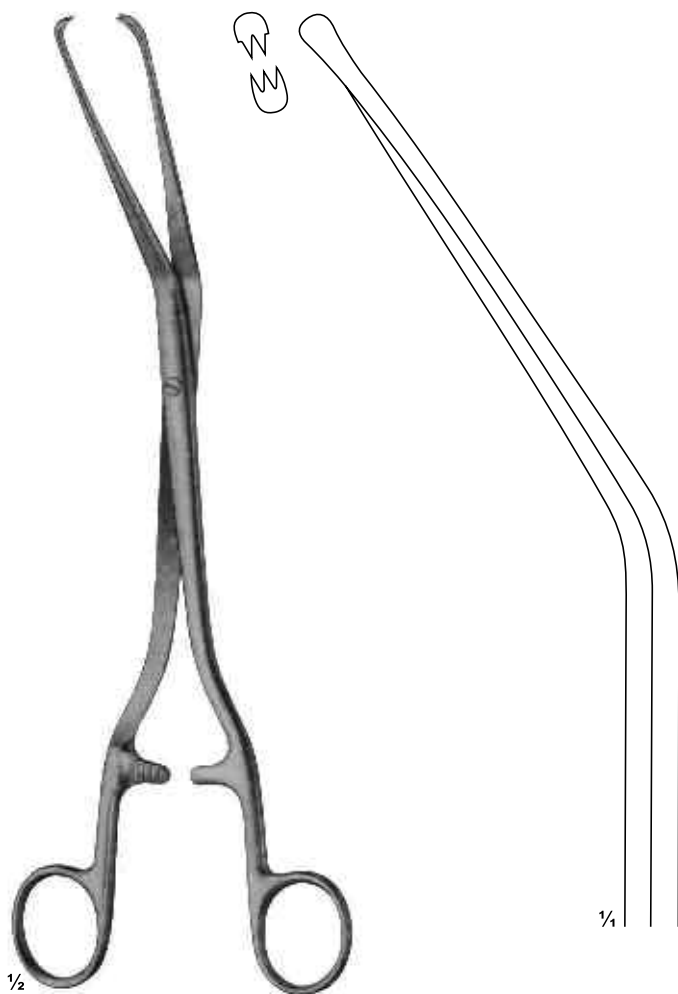

**16-107**  
HERFF  
puncturing forceps  
225 mm



**16-108**  
IOWA  
puncturing forceps  
260 mm

# Scissors of Obstetrics, Umbilical cord clamp



**16-109**  
SCHUMACHER  
Umbilical cord  
scissors  
155 mm



**16-110**  
Umbilical cord  
scissors  
105 mm

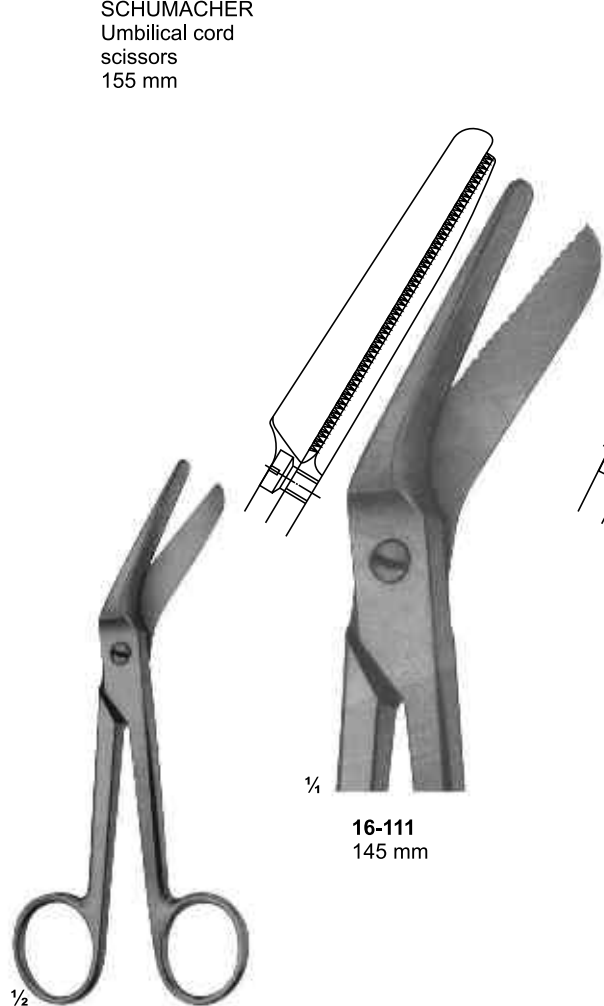

**16-111**  
145 mm

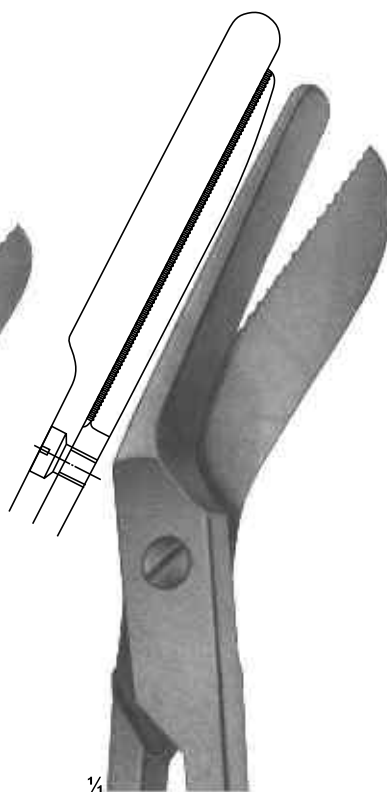

**16-112**  
200 mm

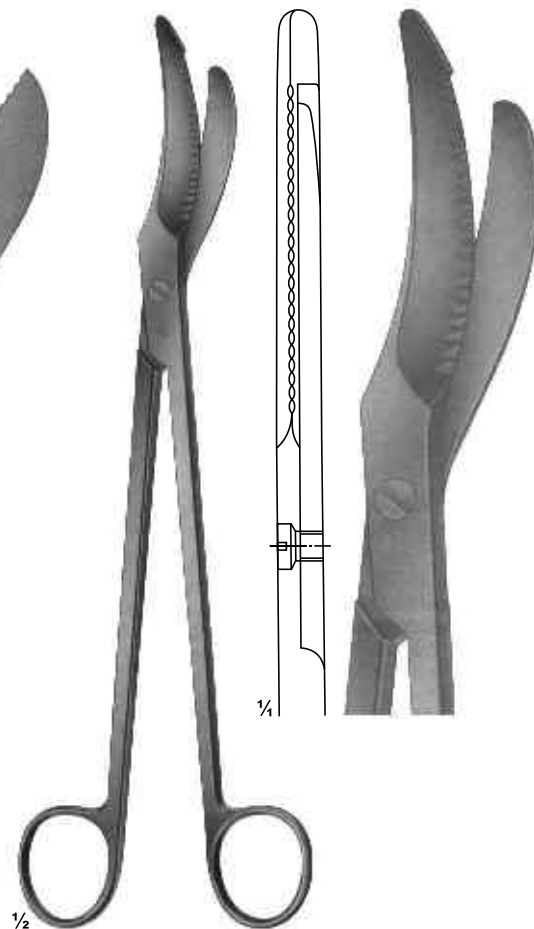

**16-113**  
Episiotomy Scissors  
240 mm



# Obstetrics Forceps



**16-114**  
355 mm



**16-115**  
400 mm



**16-116**  
SIMPSON-BRAUN  
305mm

# Obstetrics Forceps

---



**16-117**  
SIMPSON-BRAUN  
305mm



**16-118**  
SIMPSON  
235mm



**16-119**  
WRIGLEY  
250 mm

# Obstetrics Forceps

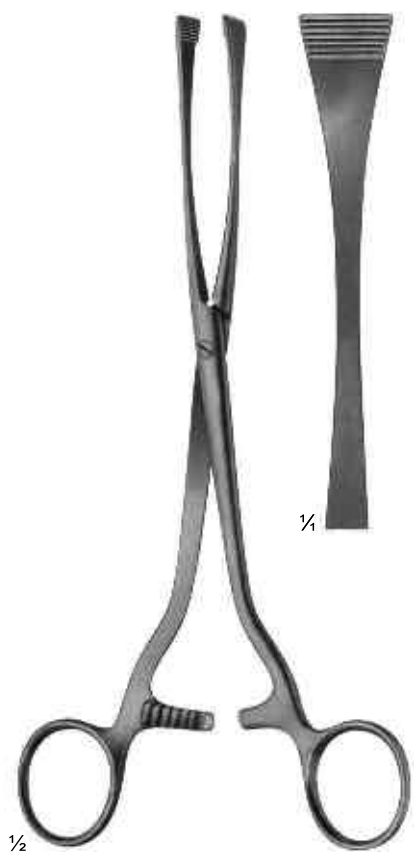

**16-120**  
**GREEN-ARMYTAGE**  
Caesarean section haemostatic  
forceps, for edges of the transverse  
incision in the lower segment  
220 mm



**16-121**  
**WILLETT**  
Scalpel Flap forceps  
185 mm



**16-122**  
**GAUSS**  
Scalpel Flap forceps  
260 mm

# Obstetrics-Placenta and Ovum Forceps

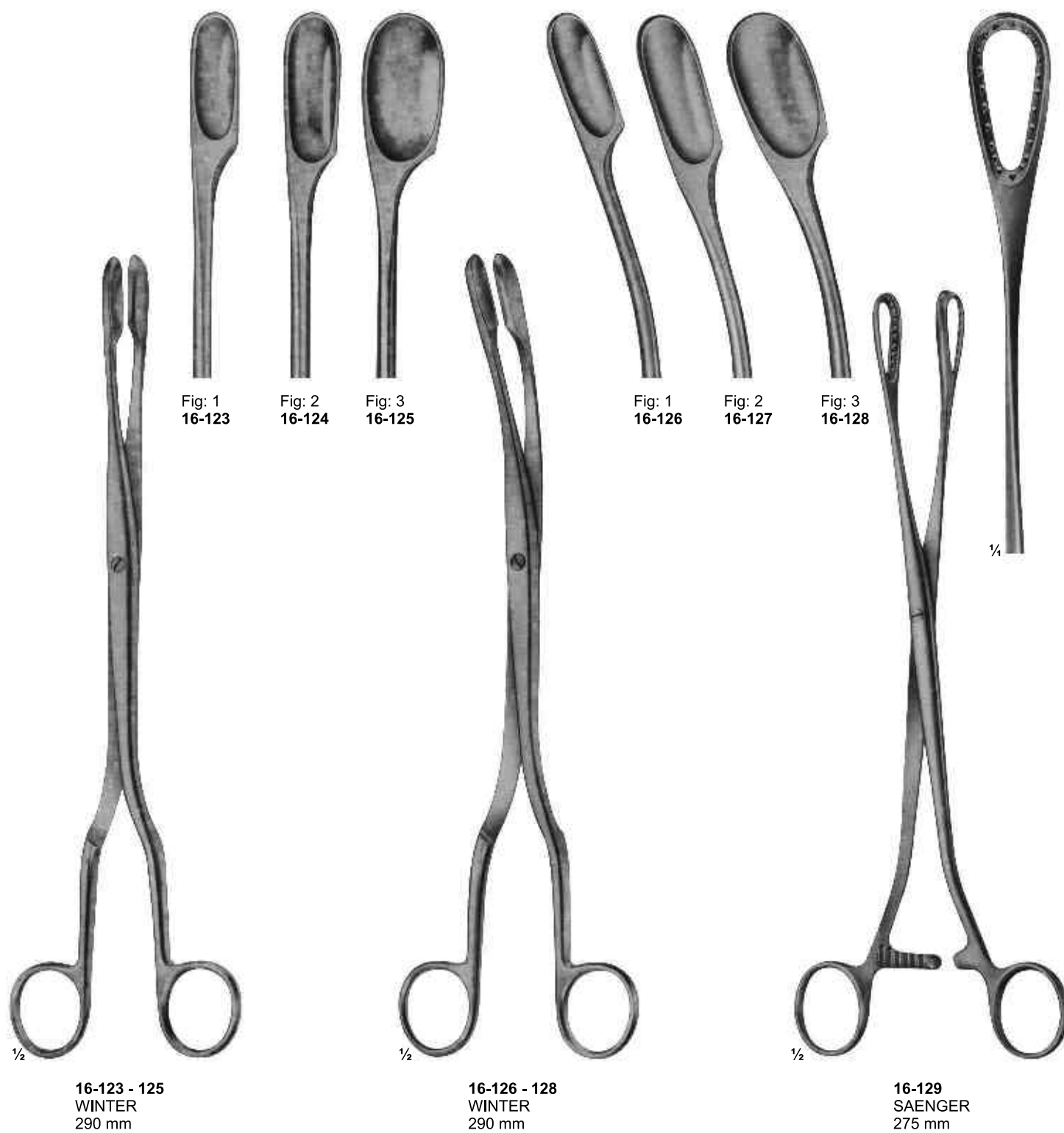

# Obstetrics-Placenta and Ovum Forceps

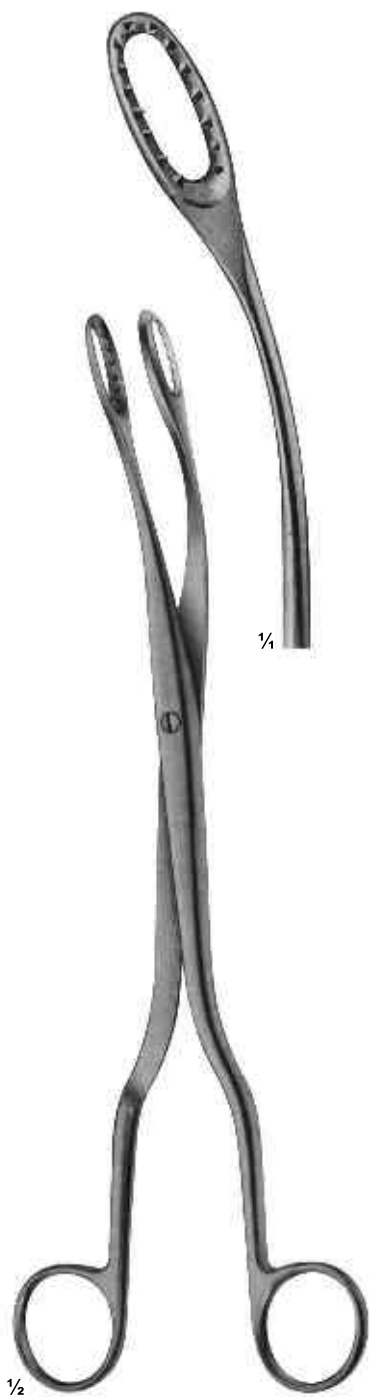

**16-130**  
SAENGER  
285 mm

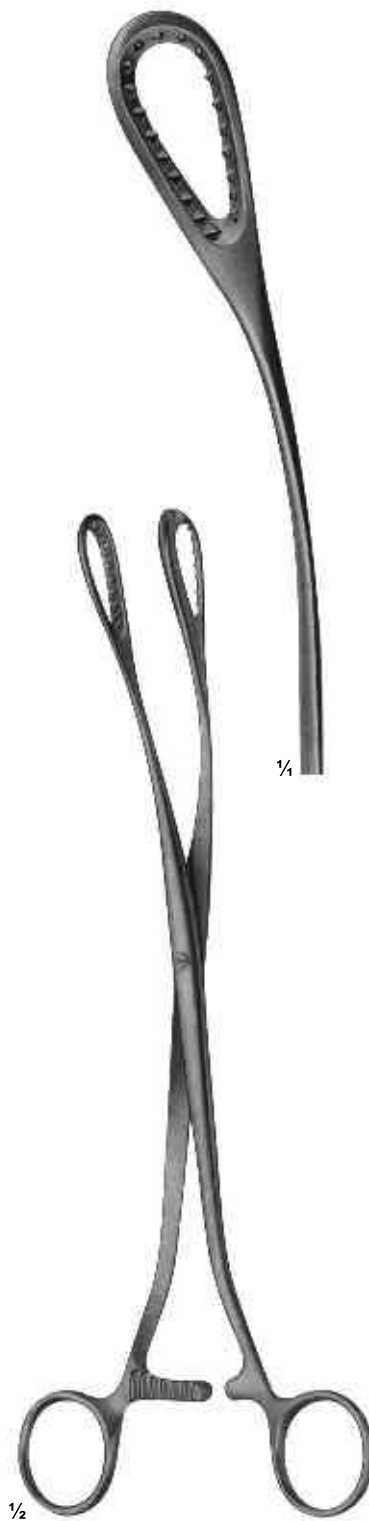

**16-131**  
SAENGER  
285 mm



$\frac{1}{4}$   
**16-132**

**16-133**



$\frac{1}{2}$   
**16-132 - 133**  
LEWKOWIZ  
245 mm

# Obstetrics-Placenta, Ovum and Cranioclast, Basiotribe Forceps

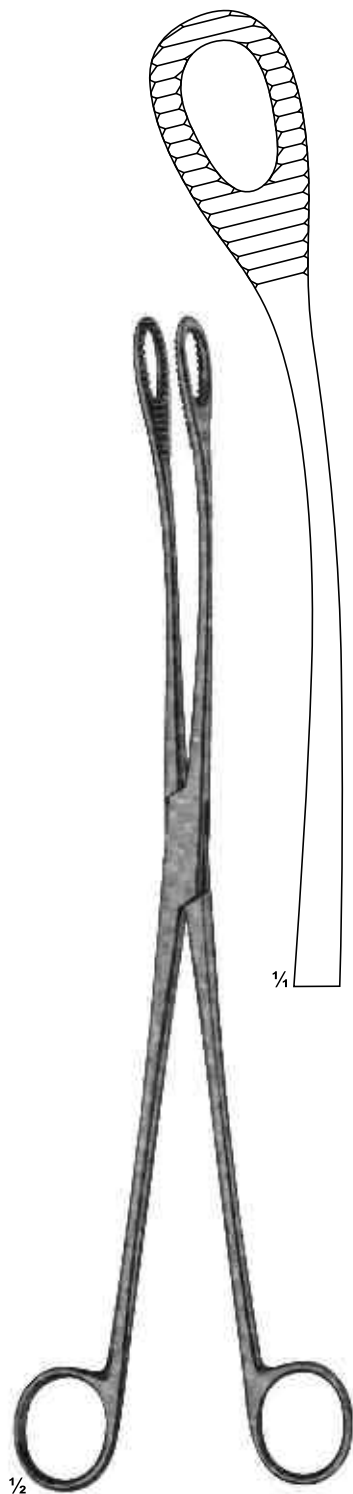

**16-134**  
KELLY  
320mm



**16-135**  
SMELLIE  
Perforator  
270mm



**16-136**  
BRAUN  
Cranioclast  
420mm

# Tracheal Tubes with inner tubes



½

**16-137**  
UECKERMANN-DENKER  
Cryothyrotomy trocar  
with silver cannula  
130mm

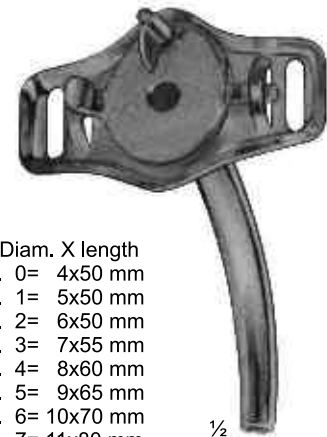

½

- Diam. X length
- 16-138** Fig. 0= 4x50 mm
  - 16-139** Fig. 1= 5x50 mm
  - 16-140** Fig. 2= 6x50 mm
  - 16-141** Fig. 3= 7x55 mm
  - 16-142** Fig. 4= 8x60 mm
  - 16-143** Fig. 5= 9x65 mm
  - 16-144** Fig. 6= 10x70 mm
  - 16-145** Fig. 7= 11x80 mm
  - 16-146** Fig. 8= 12x85 mm
  - 16-147** Fig. 9= 13x90 mm
  - 16-148** Fig. 10=14x90 mm

**16-138 - 148**  
LUER  
German silver



½

**16-149 - 158**  
JACKSON  
German Silver

- Diam. X length
- 16-149** Fig. 0= 4x50 mm
  - 16-150** Fig. 1= 5x58 mm
  - 16-151** Fig. 2= 6x58 mm
  - 16-152** Fig. 3= 7x70 mm
  - 16-153** Fig. 4= 8x78 mm
  - 16-154** Fig. 5= 9x84 mm
  - 16-155** Fig. 6= 10x84 mm
  - 16-156** Fig. 7= 11x86 mm
  - 16-157** Fig. 8= 12x88 mm
  - 16-158** Fig. 9= 13x90 mm



½

- Diam. X length
- 16-159** Fig. 1= 5x48 mm
  - 16-160** Fig. 2= 6x58 mm
  - 16-161** Fig. 3= 7x70 mm
  - 16-162** Fig. 4= 8x78 mm
  - 16-163** Fig. 5= 9x84 mm
  - 16-164** Fig. 6= 10x84 mm
  - 16-165** Fig. 7= 11x86 mm
  - 16-166** Fig. 8= 12x88 mm
  - 16-167** Fig. 9= 13x90 mm
  - 16-168** Fig.10= 14x90 mm

**16-159 - 168**  
JACKSON  
German Silver

# Tound-and Tracheal Hooks and Dilators



**16-169**  
BOSE  
165 mm



**16-170**  
BOSE  
165 mm

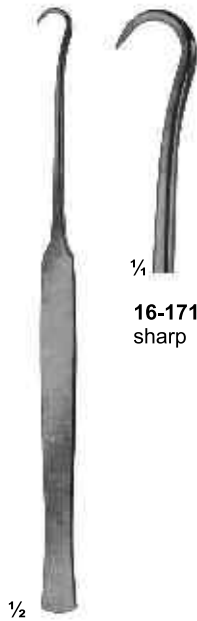

**16-171 - 173**  
180 mm

**16-171**  
sharp



**16-172**  
blunt

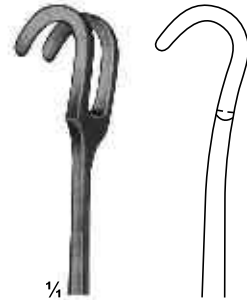

**16-173**  
stumpf/blunt

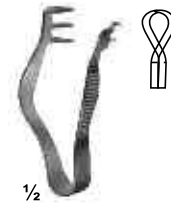

**16-174**  
FINSEN  
50 mm

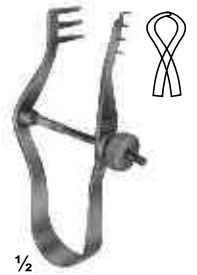

**16-175**  
FINSEN  
70 mm



**16-176**  
TROUSSEAU  
120 mm



**16-177**  
LABORDE  
125 mm



**16-178**  
LABORDE  
strong pattern  
135 mm



**16-179**  
Cleaning Brush  
for tracheal tubes  
285 mm



# Irrigating Cannulae, Embolus Grasping Forceps, Dilators

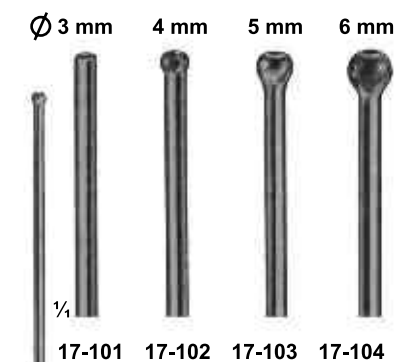

**17-101 - 104**  
**SCHMID**  
 Vessel irrigating cannulae,  
 malleable, silver plated  
 150 mm

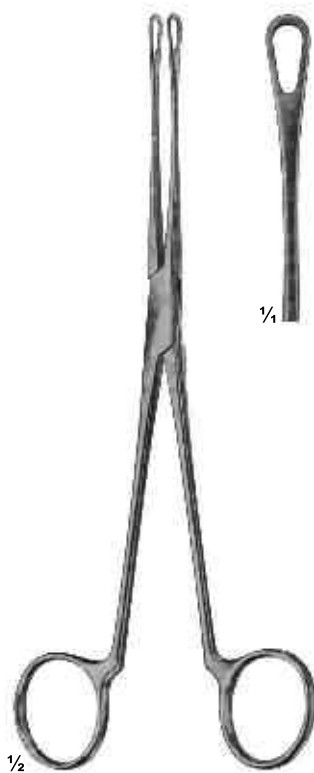

**17-105**  
**BLAKE**  
 Embolus grasping  
 forceps  
 205 mm

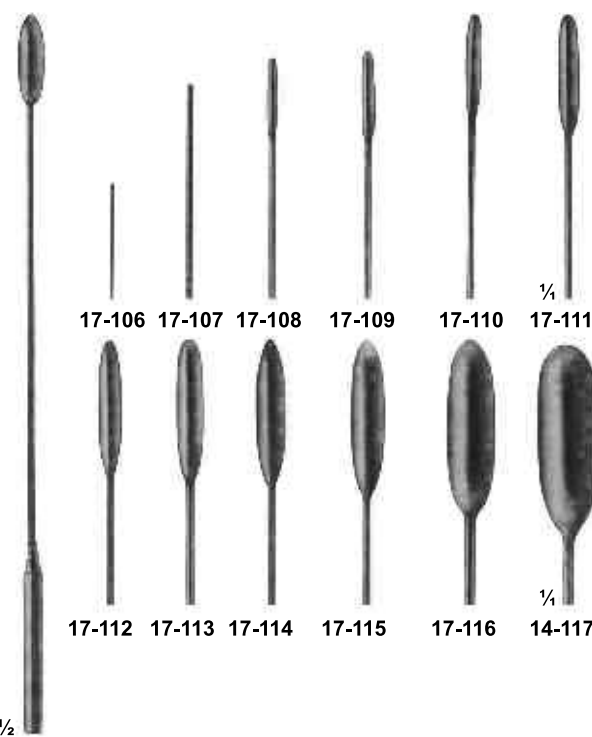

**17-106 - 117**  
**DE BAKEY**  
 Vascular dilators,  
 malleable  
 190 mm

<b>17-106</b> 0,5 mm Ø	<b>17-112</b> 3,5 mm Ø
<b>17-107</b> 1,0 mm Ø	<b>17-113</b> 4,0 mm Ø
<b>17-108</b> 1,5 mm Ø	<b>17-114</b> 4,5 mm Ø
<b>17-109</b> 2,0 mm Ø	<b>17-115</b> 5,0 mm Ø
<b>17-110</b> 2,5 mm Ø	<b>17-116</b> 7,0 mm Ø
<b>17-111</b> 3,0 mm Ø	<b>17-117</b> 9,0 mm Ø

# Irrigating Cannulae, Embolus Grasping Forceps, Dilators

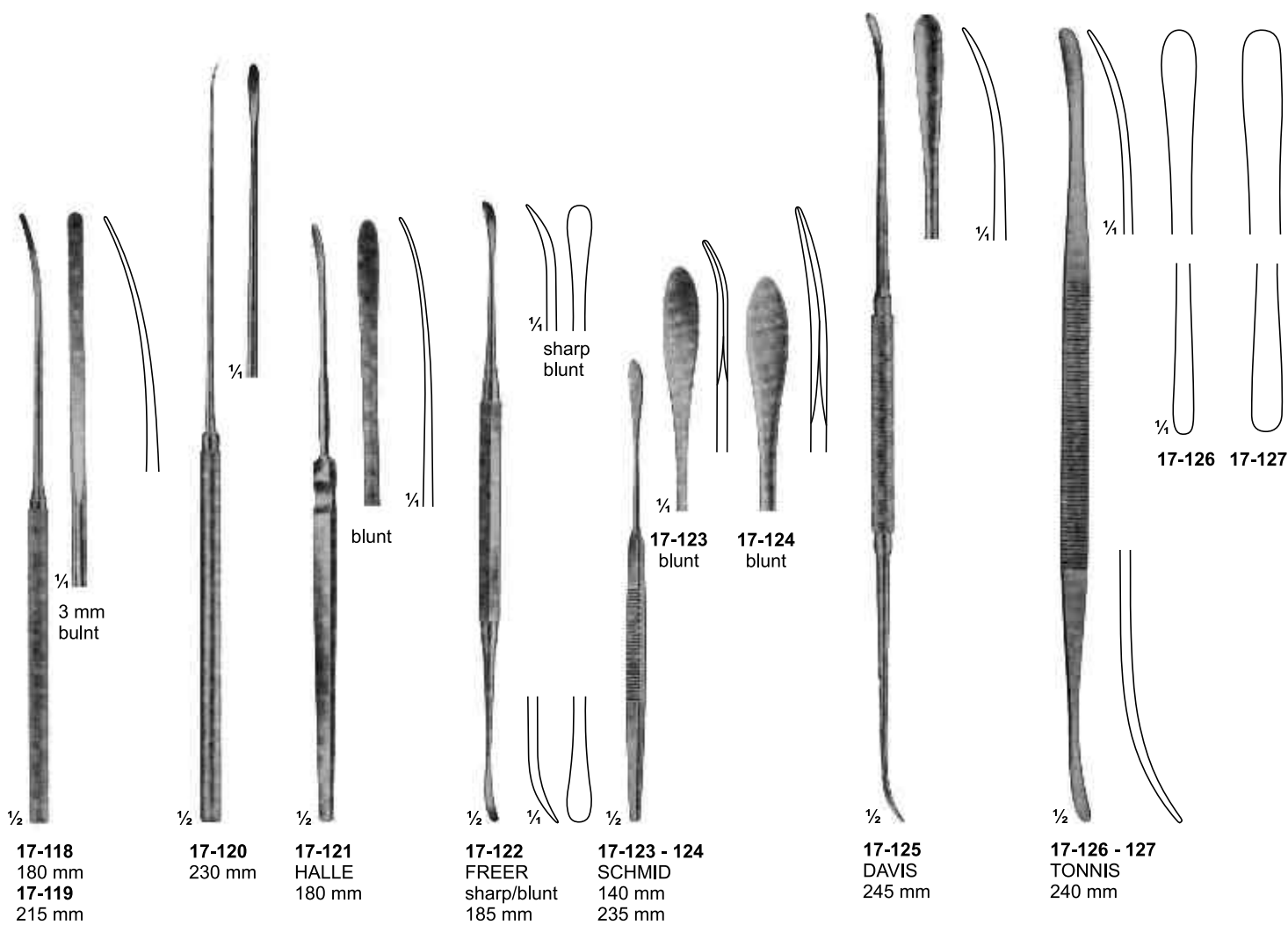

# Irrigating Cannulae, Embolus Grasping Forceps, Dilators

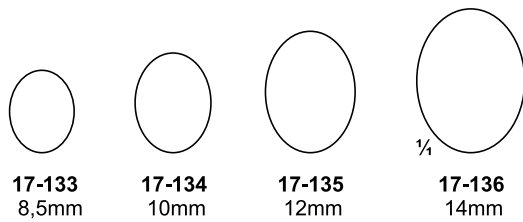
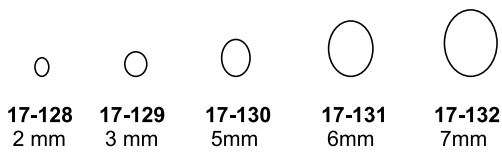

**17-128 - 136**  
Endarterectomy strippers  
550 mm



**17-137**  
Handle for  
110 mm

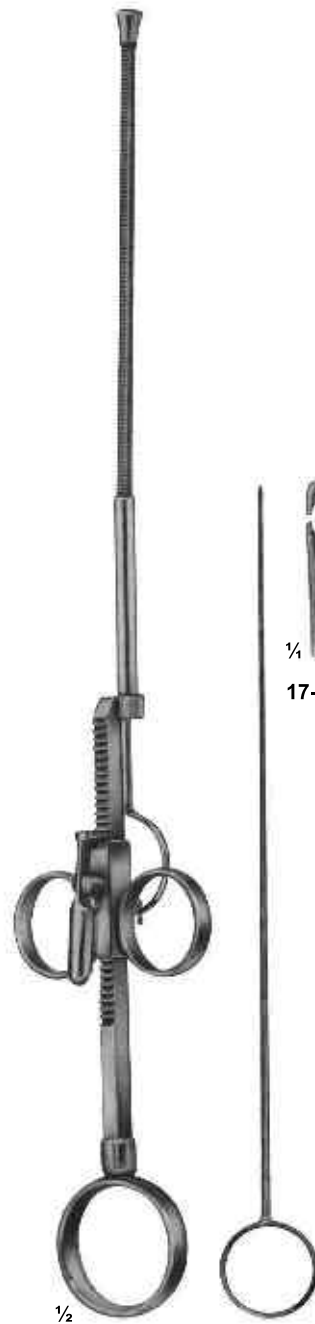

**17-138 - 139**  
RUMEL-BELBONT  
325 mm  
17-138 - 4,0 mm Ø  
17-139 - 6,4 mm Ø

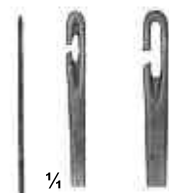

**17-140 17-141**



**17-140 - 141**  
Guide only

# Biopotome and Aortic Dilators

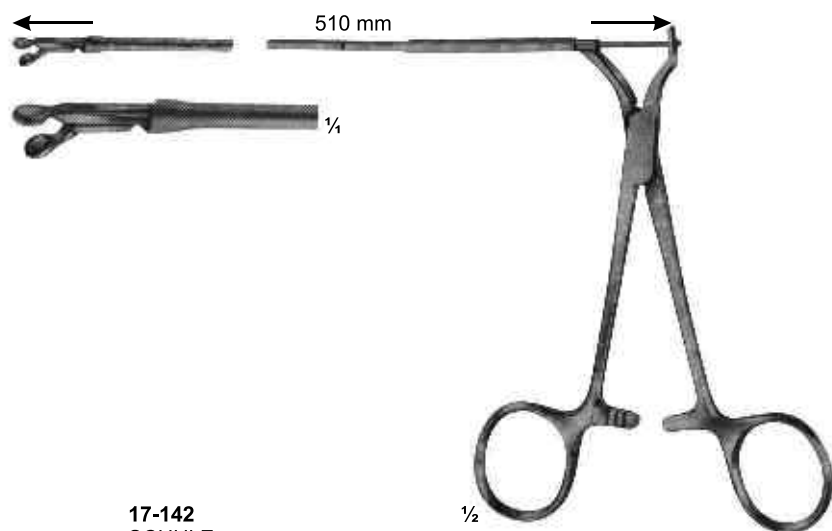

**17-142  
SCHULZ**

Biopotome, mit flexiblem Schaft, 510 mm lang,  
with round jaws 3 mm diam.

Biopsy forceps, for biopsy from the right atrium  
through cava juglaris, prior to heart implantations.

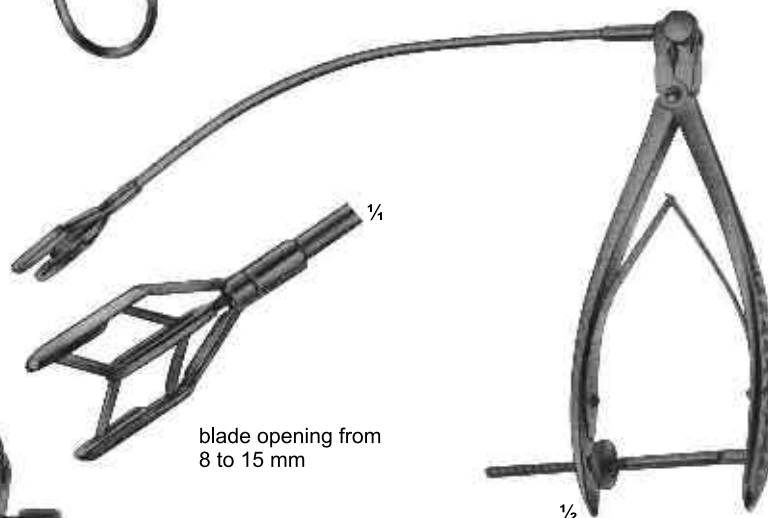

**17-144  
COOLEY**  
Dilator for  
mitral valve  
for children

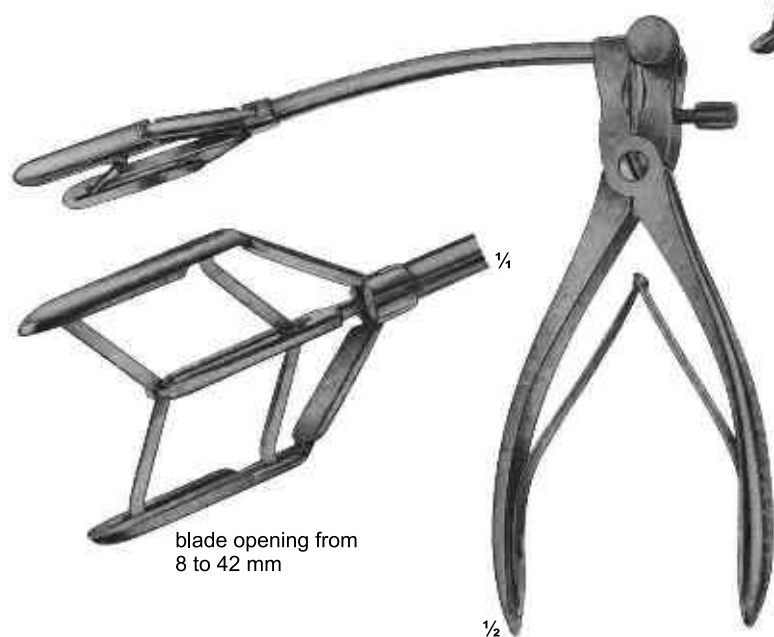

**17-143  
TUBBS**  
Dilator for  
mitral valve

blade opening from  
8 to 42 mm

blade opening from  
8 to 15 mm

# Biopotome and Aortic Dilators

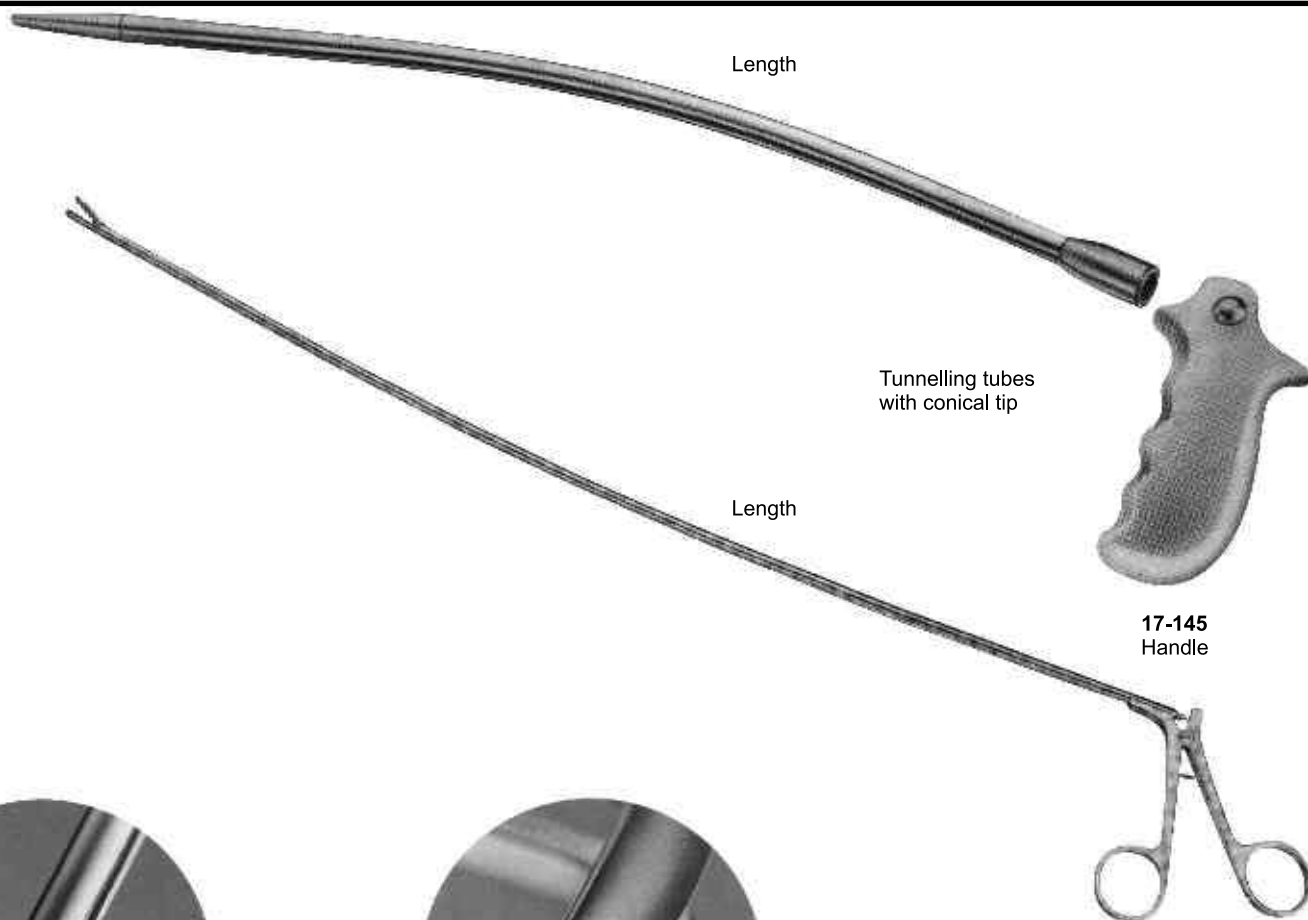

**DE BAKEY**  
17-147  
1 : 2 rows of teeth

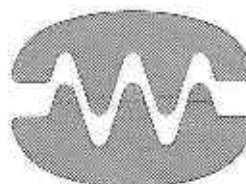

**DE BAKEY**  
17-148  
2 : 3 rows of teeth

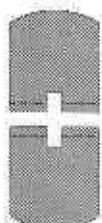
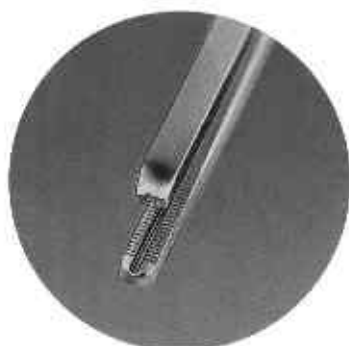

**COOLEY**  
17-149  
2 : 2 rows of teeth



**DARDIK**  
17-150  
2 : 3 rows of teeth

# Ultra-Light-Forceps

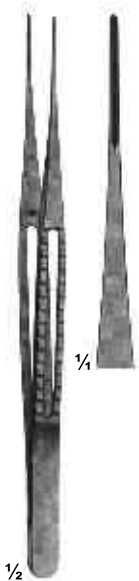

**17-151**  
Width of jaws  
1,5 mm  
Length  
150mm

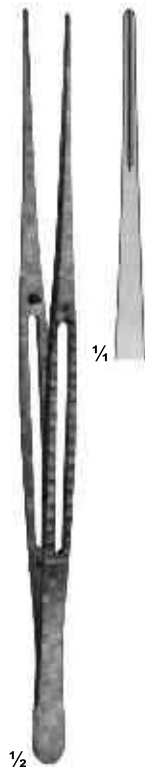

**17-152**  
1,5 mm  
200 mm



**17-153**  
1,5 mm  
240 mm



**17-154**  
1,5 mm  
300 mm

# Ultra-Light-Forceps

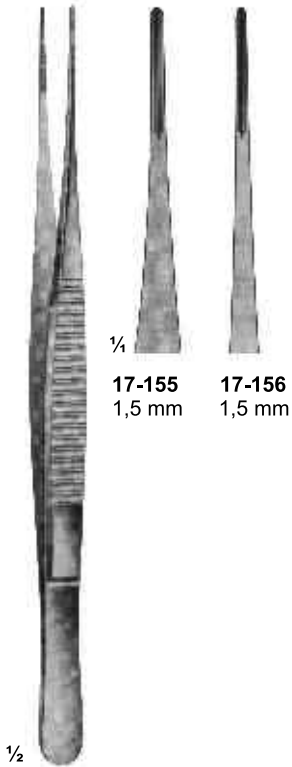

$\frac{1}{4}$   
**17-155** 1,5 mm  
**17-156** 1,5 mm

$\frac{1}{2}$   
**17-155 - 156**  
 DE BAKEY  
 150 mm  
 300 mm

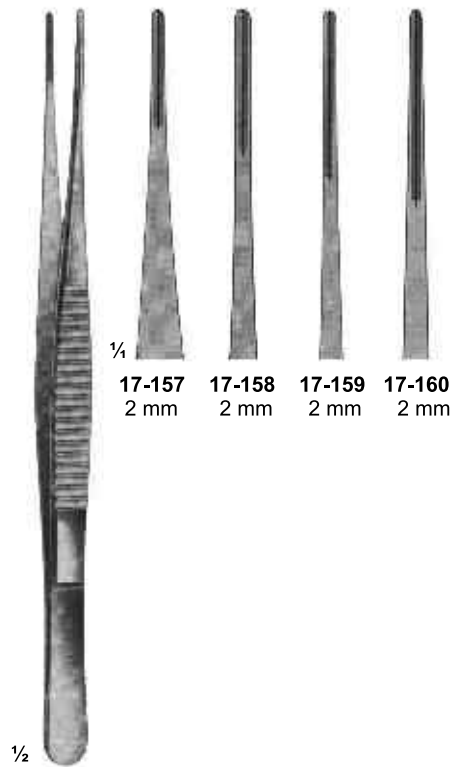

$\frac{1}{4}$   
**17-157** 2 mm  
**17-158** 2 mm  
**17-159** 2 mm  
**17-160** 2 mm

$\frac{1}{2}$   
**17-157 - 160**  
 DE BAKEY  
 150 mm 200 mm  
 300 mm 240 mm

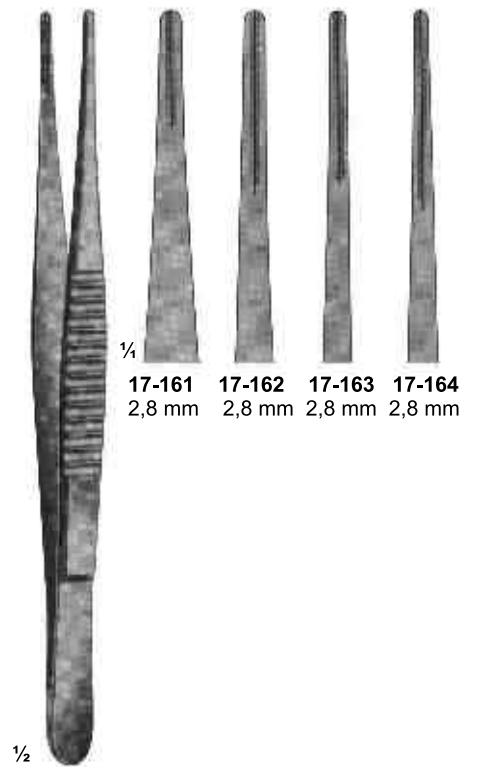

$\frac{1}{4}$   
**17-161** 2,8 mm  
**17-162** 2,8 mm  
**17-163** 2,8 mm  
**17-164** 2,8 mm

$\frac{1}{2}$   
**17-161 - 164**  
 DE BAKEY  
 150 mm 200 mm  
 300 mm 240 mm

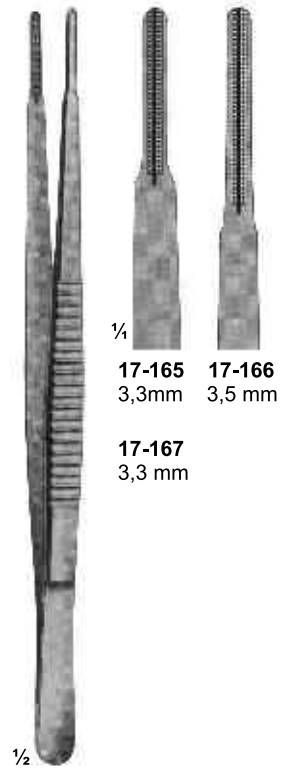

$\frac{1}{4}$   
**17-165** 3,3mm  
**17-166** 3,5 mm

**17-167**  
 3,3 mm

$\frac{1}{2}$   
**17-165 - 167**  
 DE BAKEY  
 200 mm  
 300 mm 240 mm

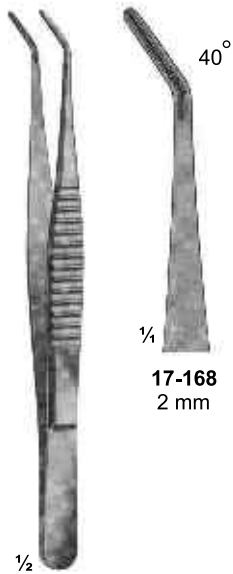

40°

$\frac{1}{4}$   
**17-168**  
 2 mm

$\frac{1}{2}$   
**17-168**  
 DE BAKEY  
 150 mm

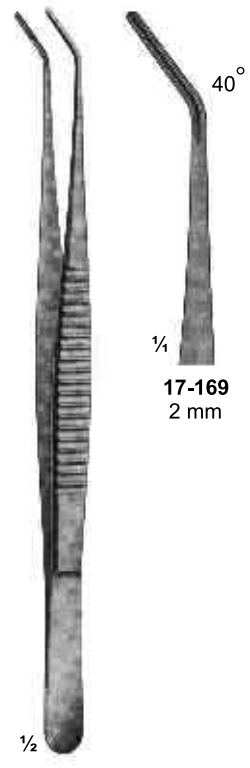

40°

$\frac{1}{4}$   
**17-169**  
 2 mm

$\frac{1}{2}$   
**17-169**  
 DE BAKEY  
 200 mm

# Ring Handle Bulldog Clamps

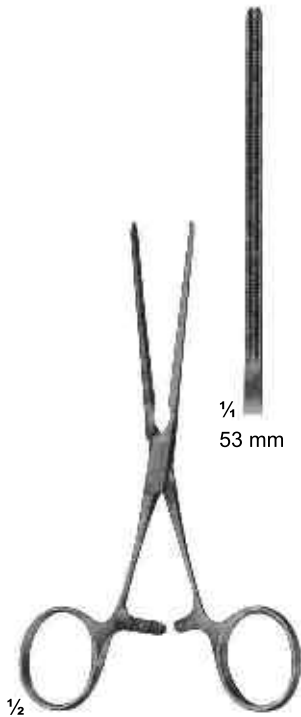

**17-170**  
DE-BAKEY  
gerade straight  
130 mm

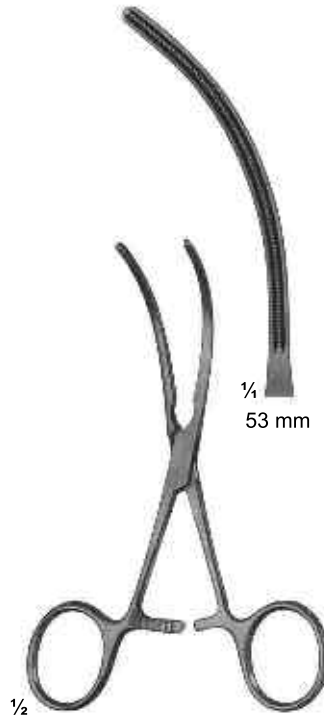

**17-171**  
DE-BAKEY  
Maul gebogen  
curved jaws  
125 mm

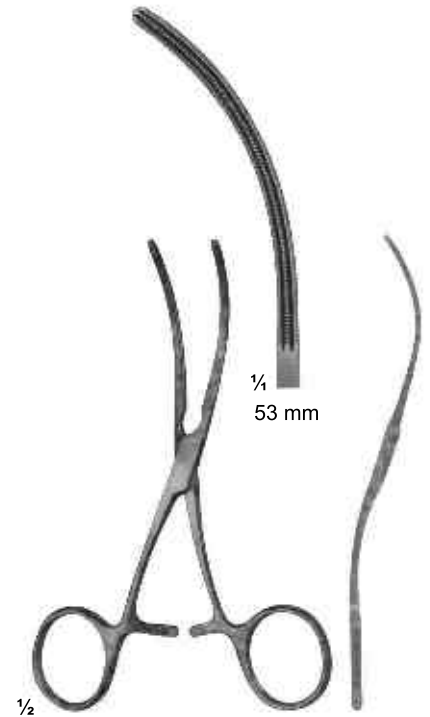

**17-172**  
DE-BAKEY  
S-shaped curved  
125 mm

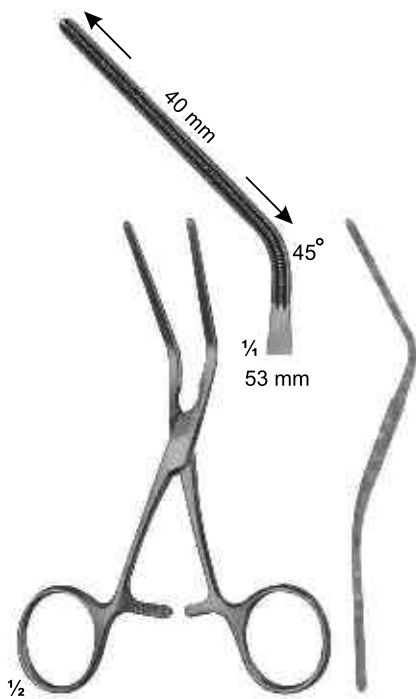

**17-173**  
DE-BAKEY  
45° winklig gebogen  
angled 45°  
125 mm

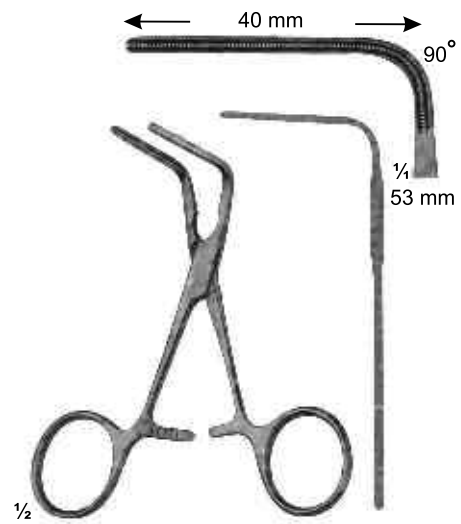

**17-174**  
DE-BAKEY  
90° winklig gebogen  
angled 90°  
105 mm



# Anastomosis-and Multi-Purpose-Clamps for Neonatales

graduated



1/2

**17-175 - 178**  
CASTANESA

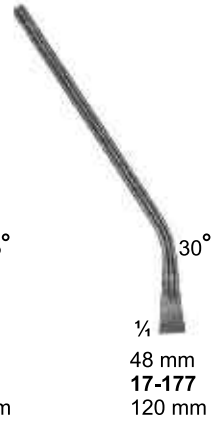
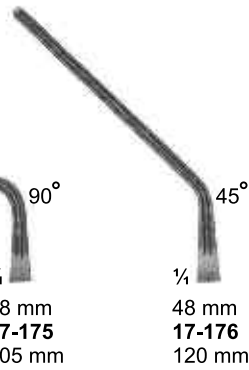
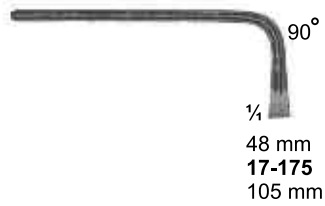

graduated



1/2

**17-179 - 182**  
CASTANESA

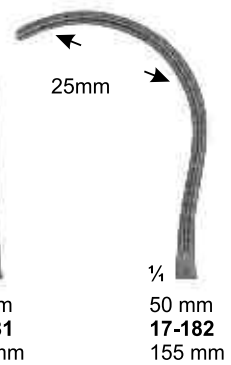
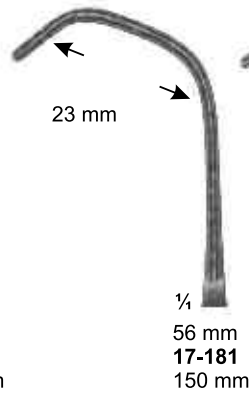
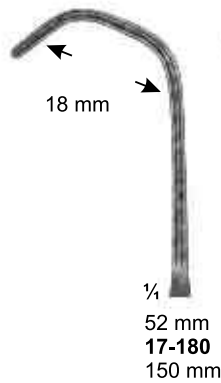
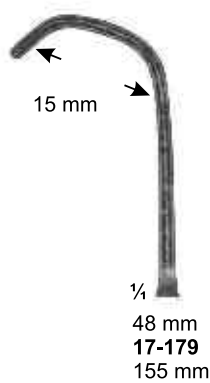

# Anastomosis-and Multi-Purpose-Clamps-Pediatric types

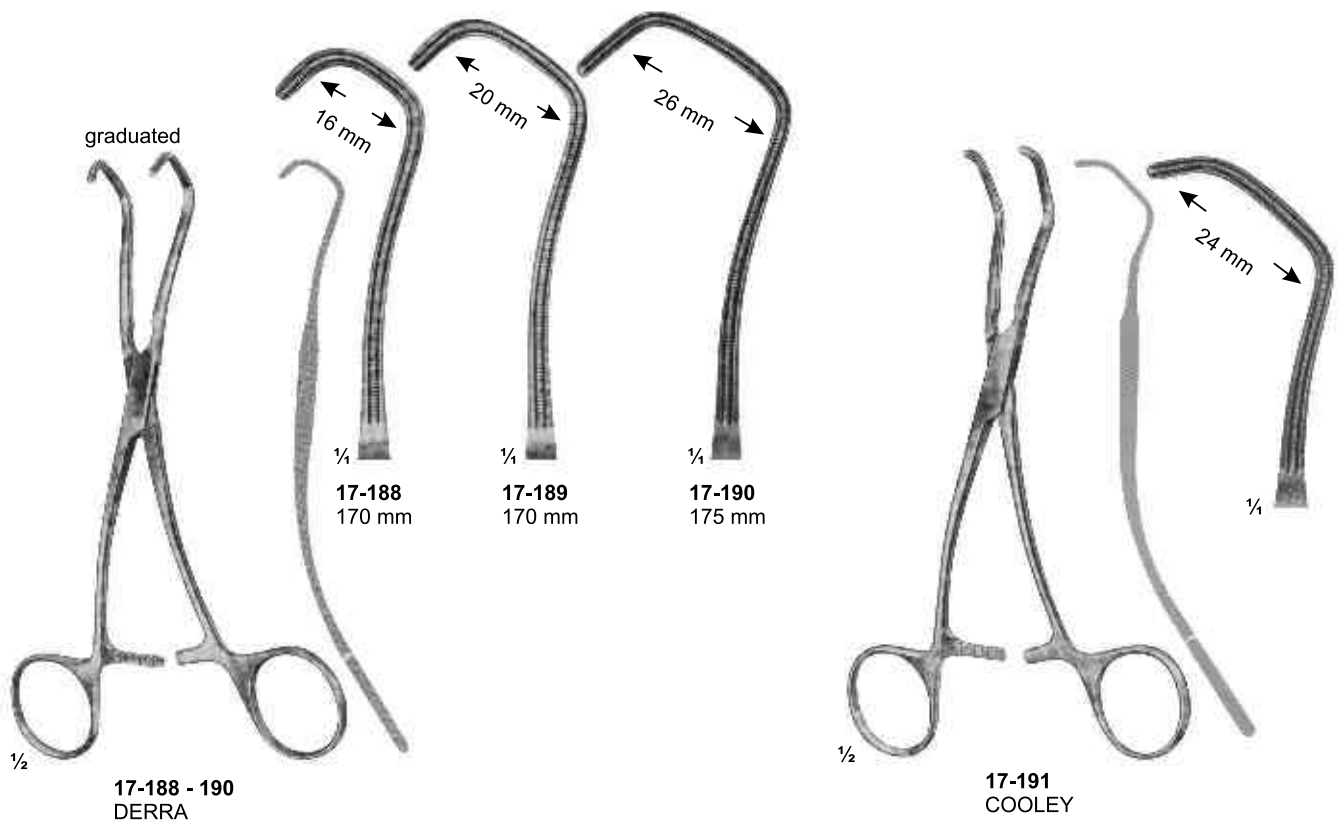
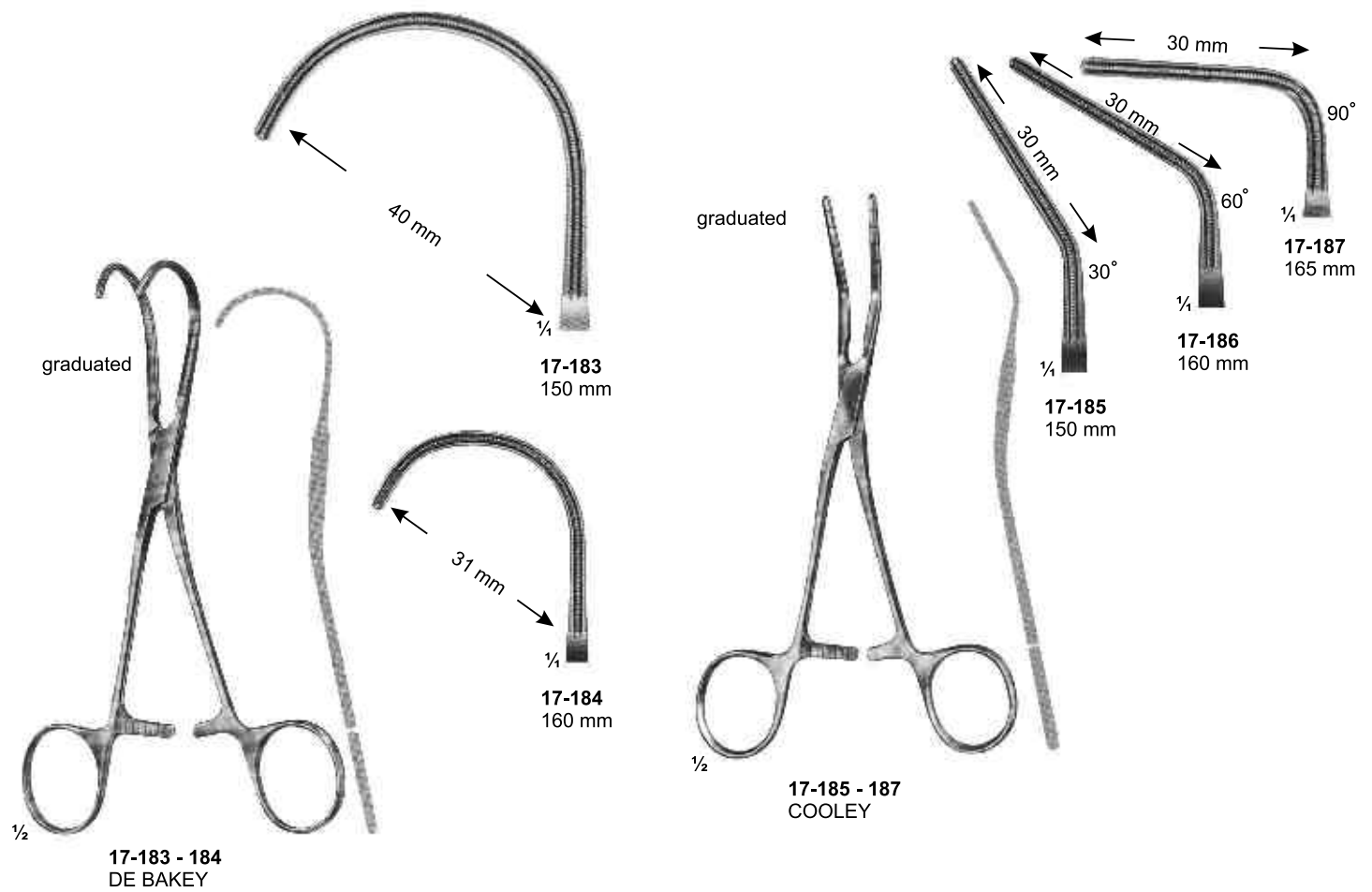

# Non-traumatic Haemostatic Forceps

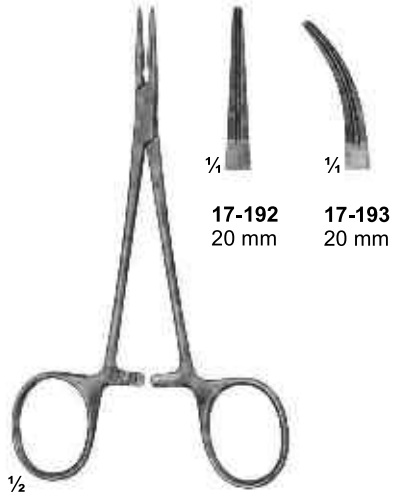

**17-192**  
20 mm

**17-193**  
20 mm

**17-192 - 193**  
125 mm

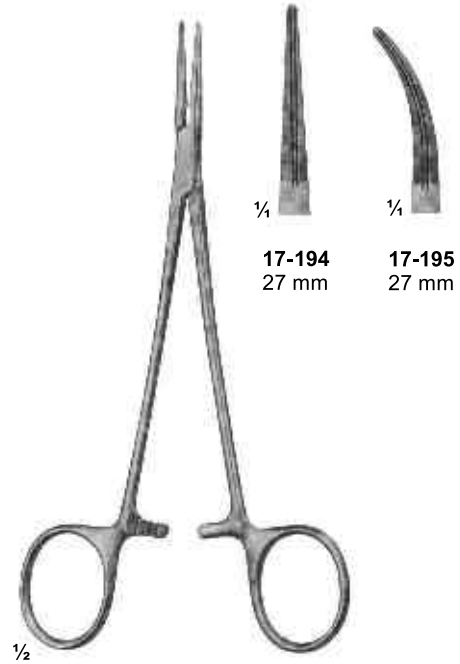

**17-194**  
27 mm

**17-195**  
27 mm

**17-194 - 195**  
165 mm

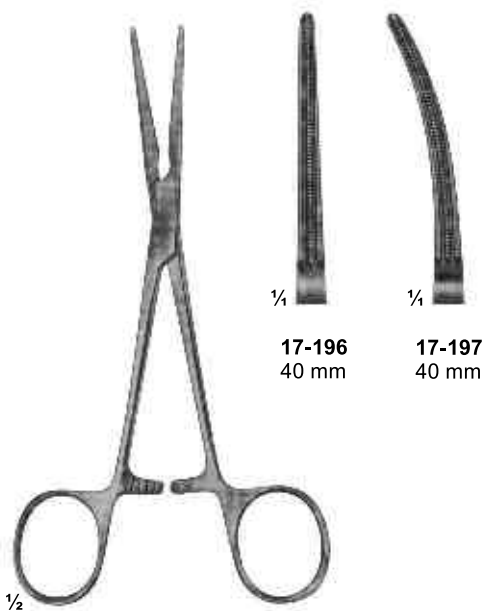

**17-196**  
40 mm

**17-197**  
40 mm

**17-196 - 197**  
DE BAKEY-BAINRIDGE  
155 mm

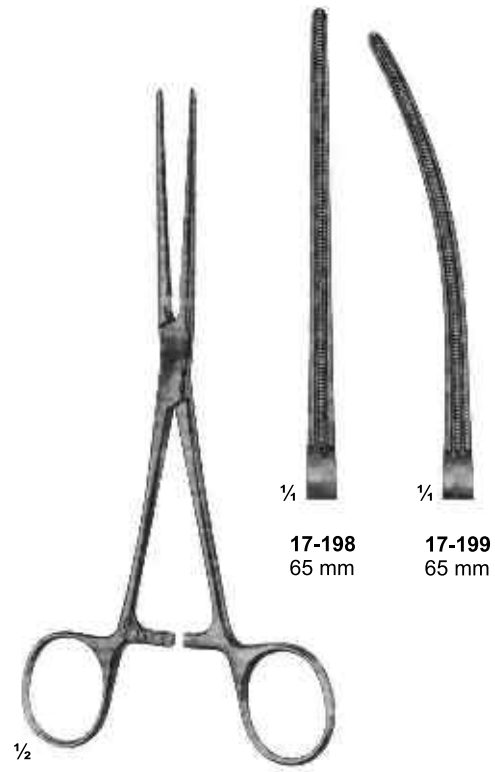

**17-198**  
65 mm

**17-199**  
65 mm

**17-198 - 199**  
DE BAKEY-BAINRIDGE  
180 mm

# Non-traumatic Haemostatic Forceps

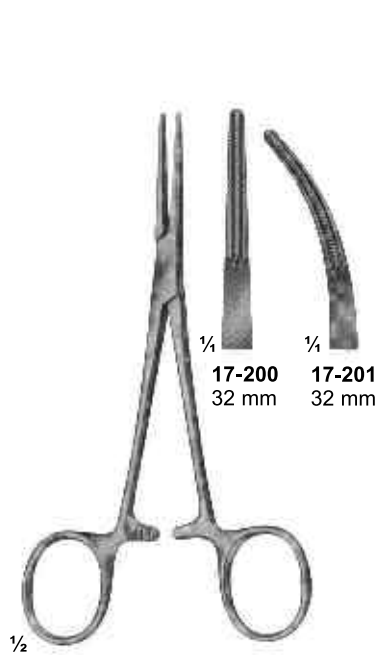

**17-200 - 201**  
DE-BAKEY-KELLY  
140 mm

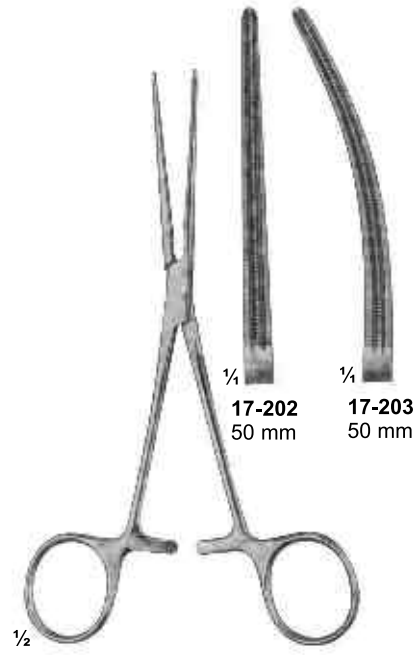

**17-202 - 203**  
PEAN  
155 mm

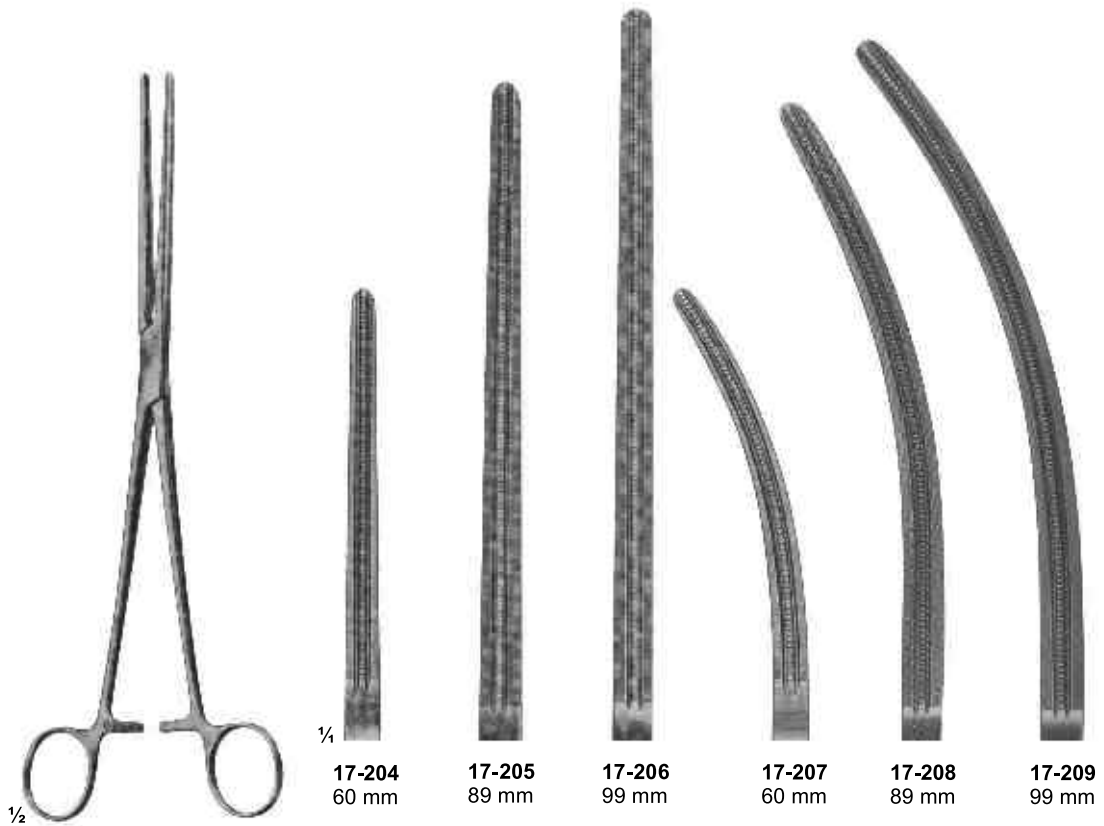

**17-204 - 209**  
DE-BAKEY-PEAN DE-BAKEY-PEAN  
17-204 200 mm 17-207 200 mm  
17-205 265 mm 17-208 260 mm  
17-206 280 mm 17-209 275 mm

# Anastomosis Clamps

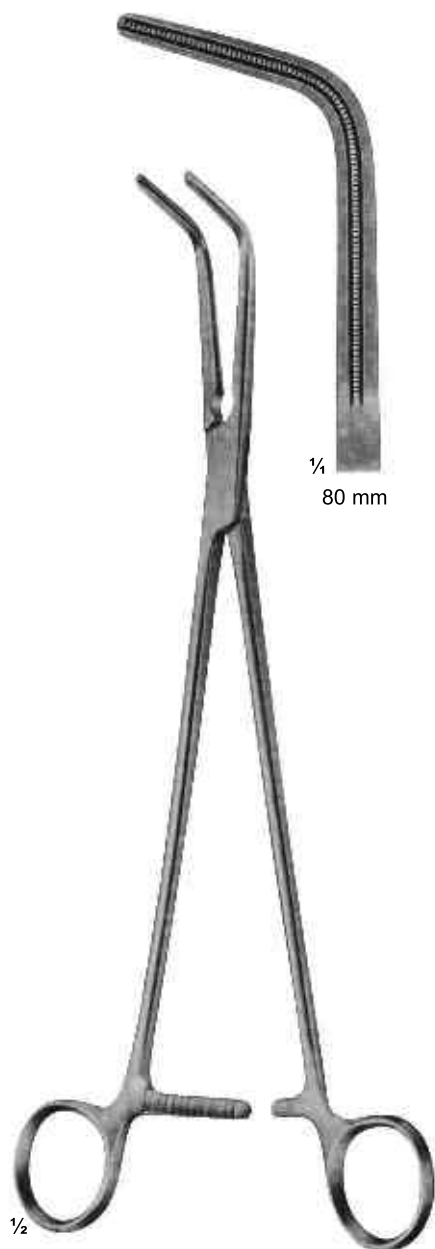

**17-210**  
DE-BAKEY-MIXTER  
285 mm

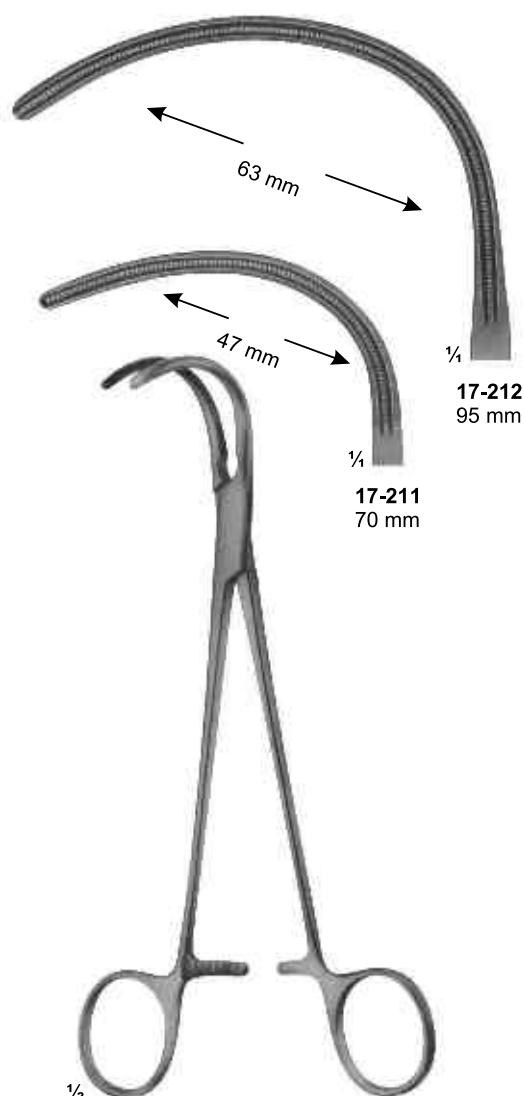

**17-211 - 212**  
GLOVER  
245 mm



**17-213**  
GLOVER  
220 mm

# Vena-Cava Clamps

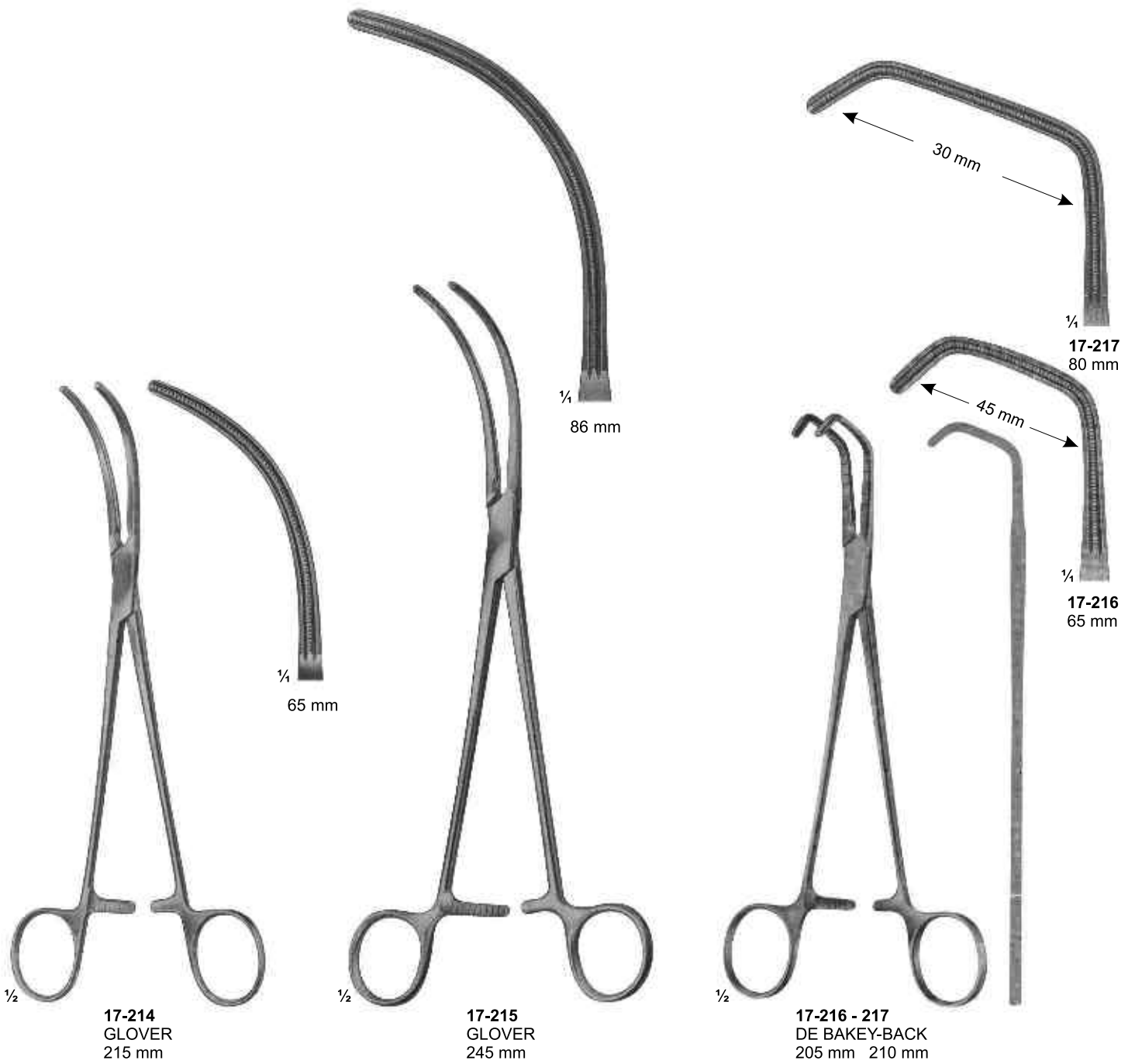

# Vena-Cava Clamps

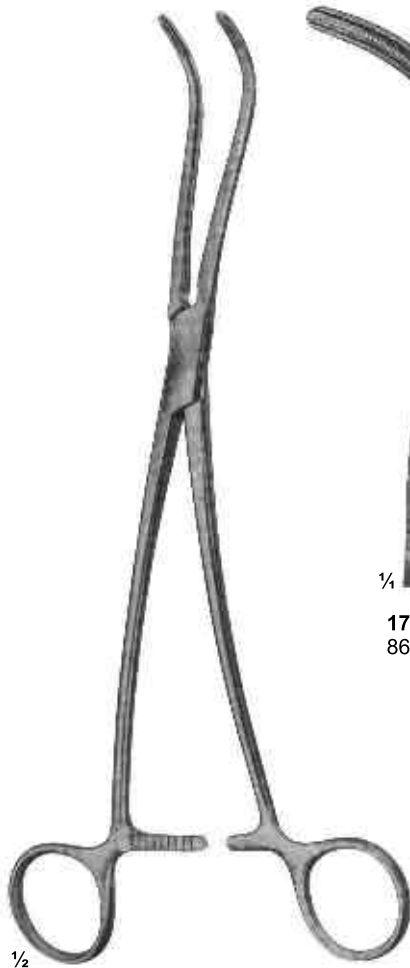

1/2

1/4  
17-218  
86 mm

1/4  
17-219  
86 mm

1/4  
17-220  
86 mm

1/4  
17-221  
86 mm

17-218 - 221  
DE BAKEY-HARKEN  
17-218 - 255 mm  
17-219 - 245 mm  
17-220 - 245 mm  
17-221 - 245 mm



1/2

17-222 - 226  
DE BAKEY

Total Length: 220 mm  
Length of jaws: 85 mm

1/4  
17-222

36 mm

1/4  
17-223

48 mm

1/4  
17-224

54 mm

1/4  
17-225

58 mm

1/4  
17-226

75 mm

# Vena-Cava Clamps

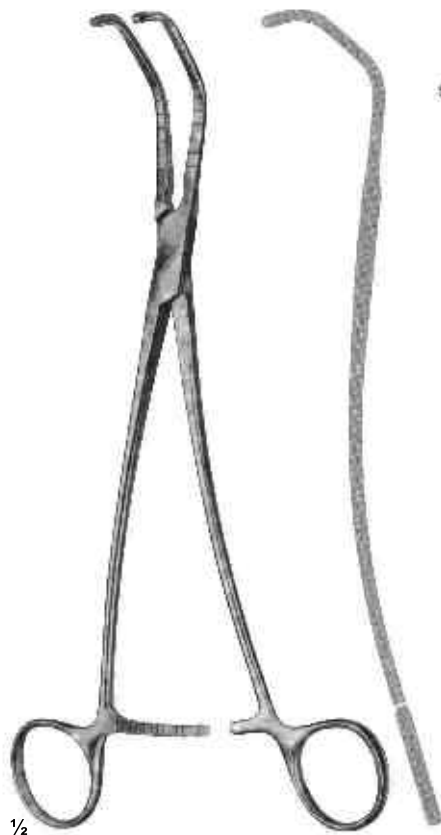

1/2

**17-227 - 229**  
DE BAKEY-SATINSKY  
235 mm, 240 mm, 245 mm

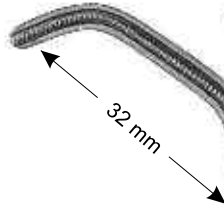

1/4

**17-227**  
68 mm

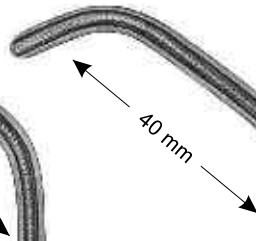

1/4

**17-228**  
76 mm

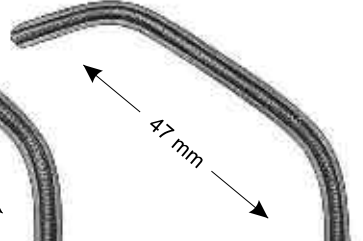

1/4

**17-229**  
84 mm

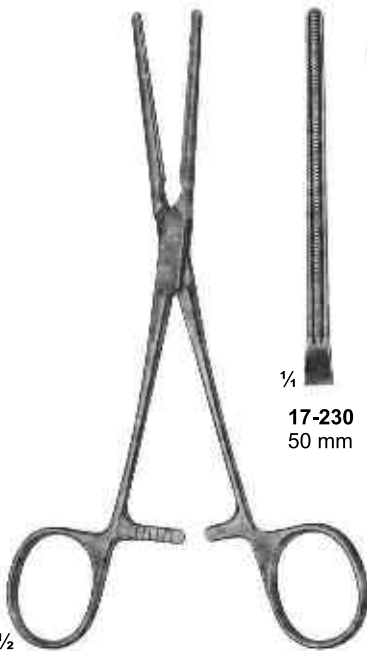

1/2

**17-230 - 231**  
DE BAKEY  
170 mm, 165 mm



1/4

**17-230**  
50 mm



1/4

**17-231**  
50 mm



1/2

**17-232**  
DE BAKEY  
165 mm



1/4

50 mm



# Vena-Cava Clamps

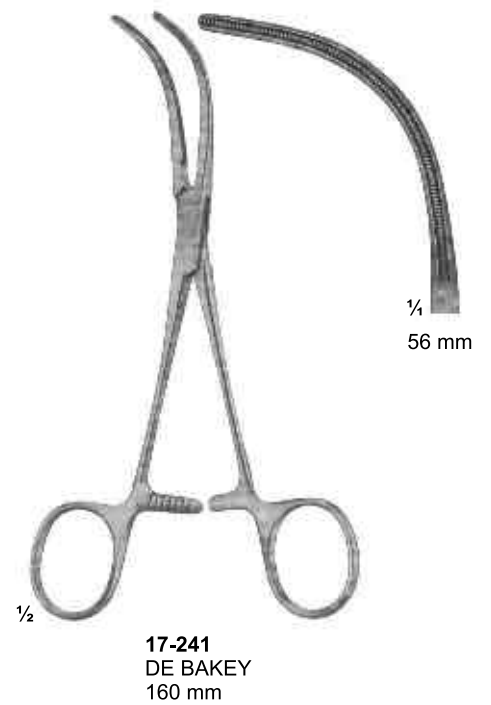
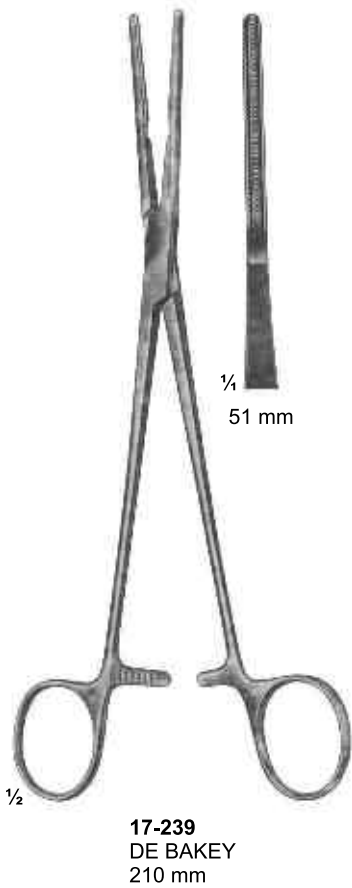
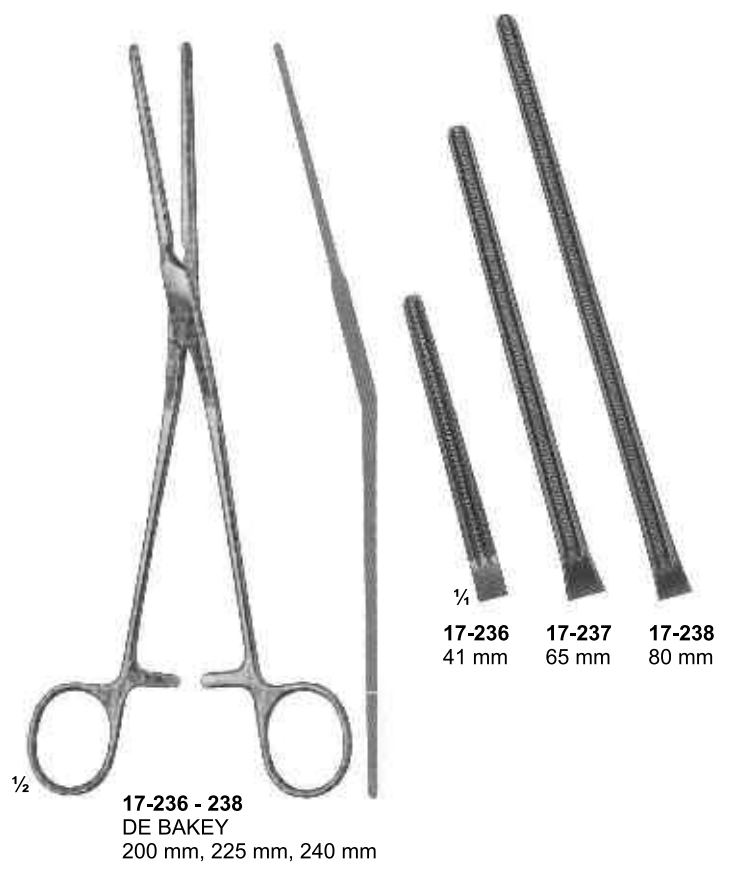
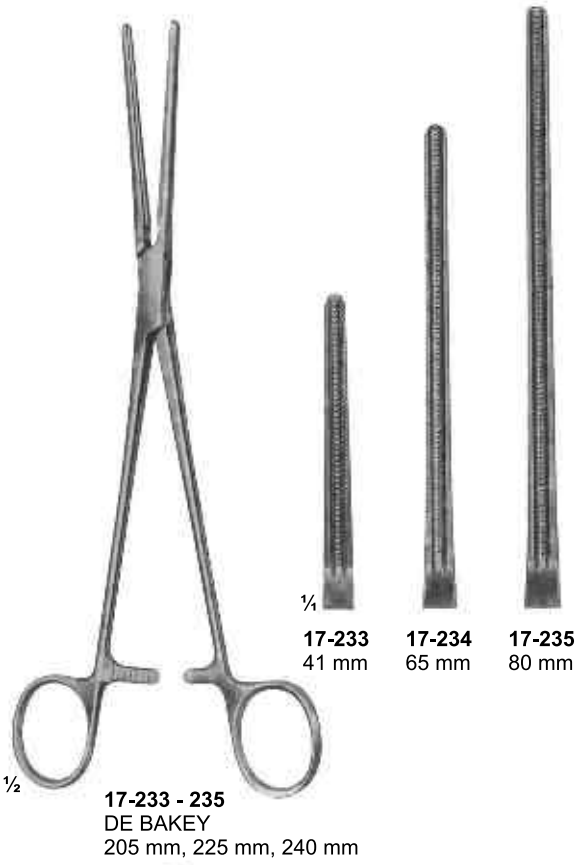

# Vena-Cava Clamps

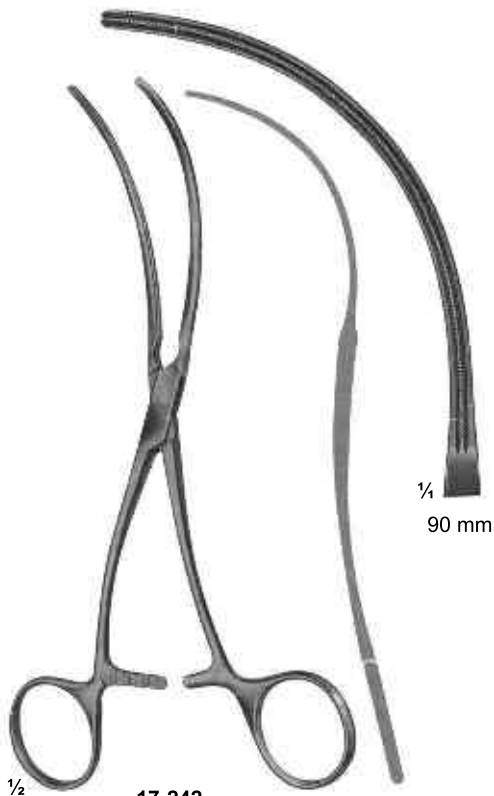

**17-242**  
DE BAKEY  
190 mm

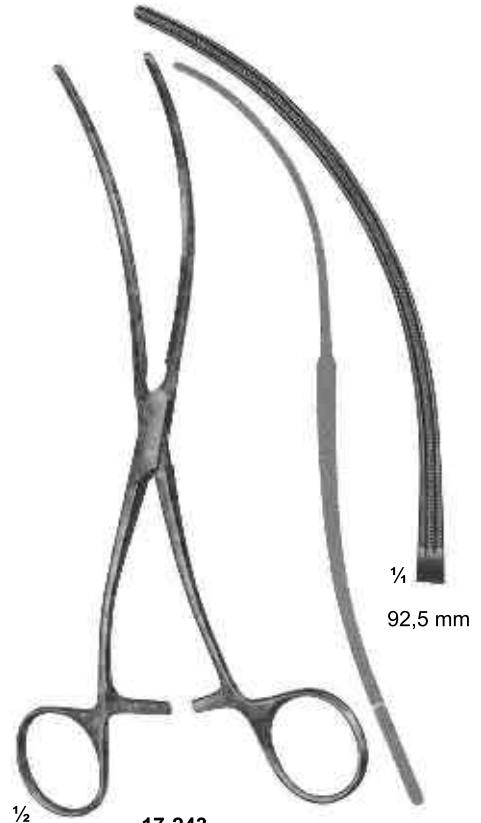

**17-243**  
DE BAKEY  
200 mm

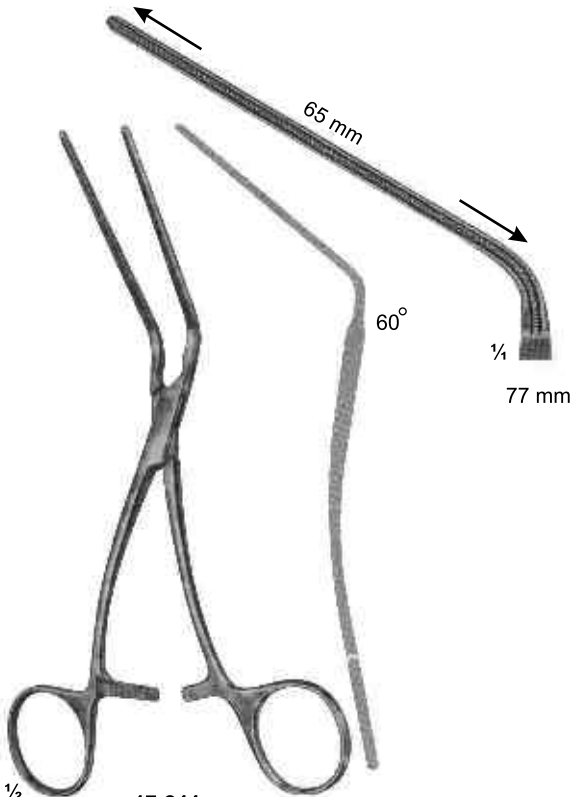

**17-244**  
DE BAKEY  
180 mm

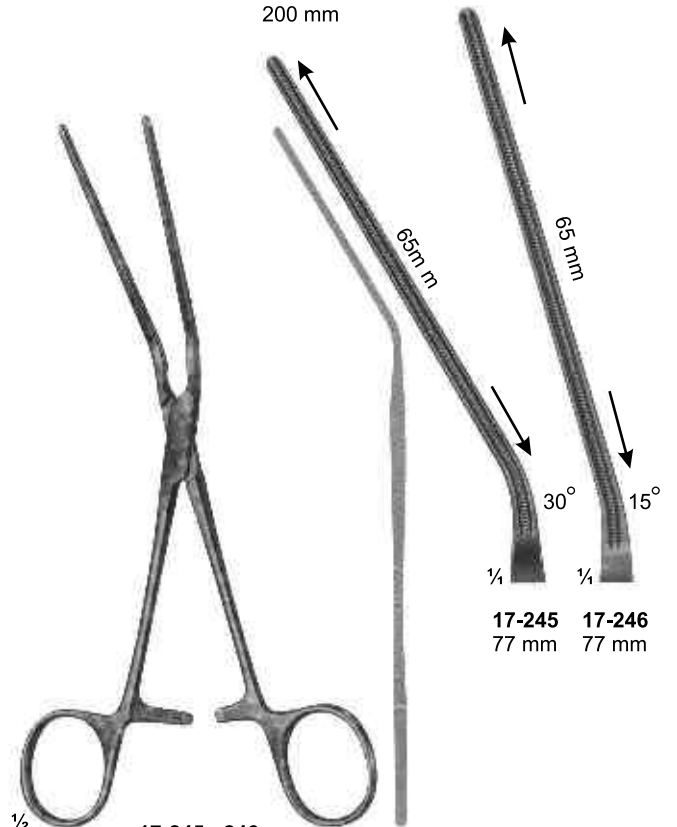

**17-245 - 246**  
DE BAKEY  
190 mm

**17-245** 77 mm  
**17-246** 77 mm

# Vena-Cava Clamps



**17-247**  
LELAND-JONES  
195 mm



**17-248**  
DE BAKEY  
200 mm

Iliac clamp

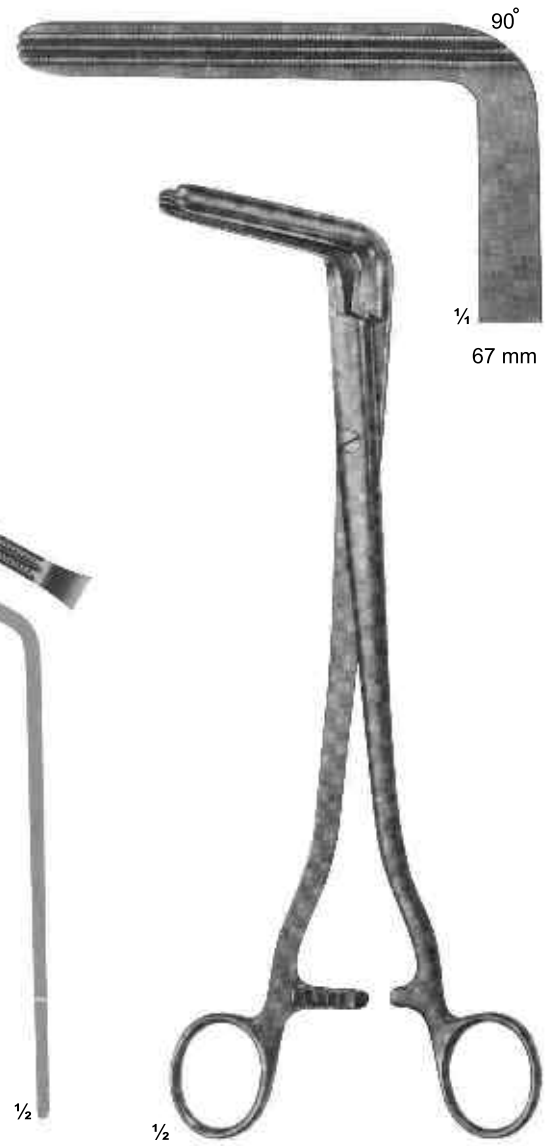

**17-249**  
WERTHEIM  
250 mm

# Vena-Cava Clamps

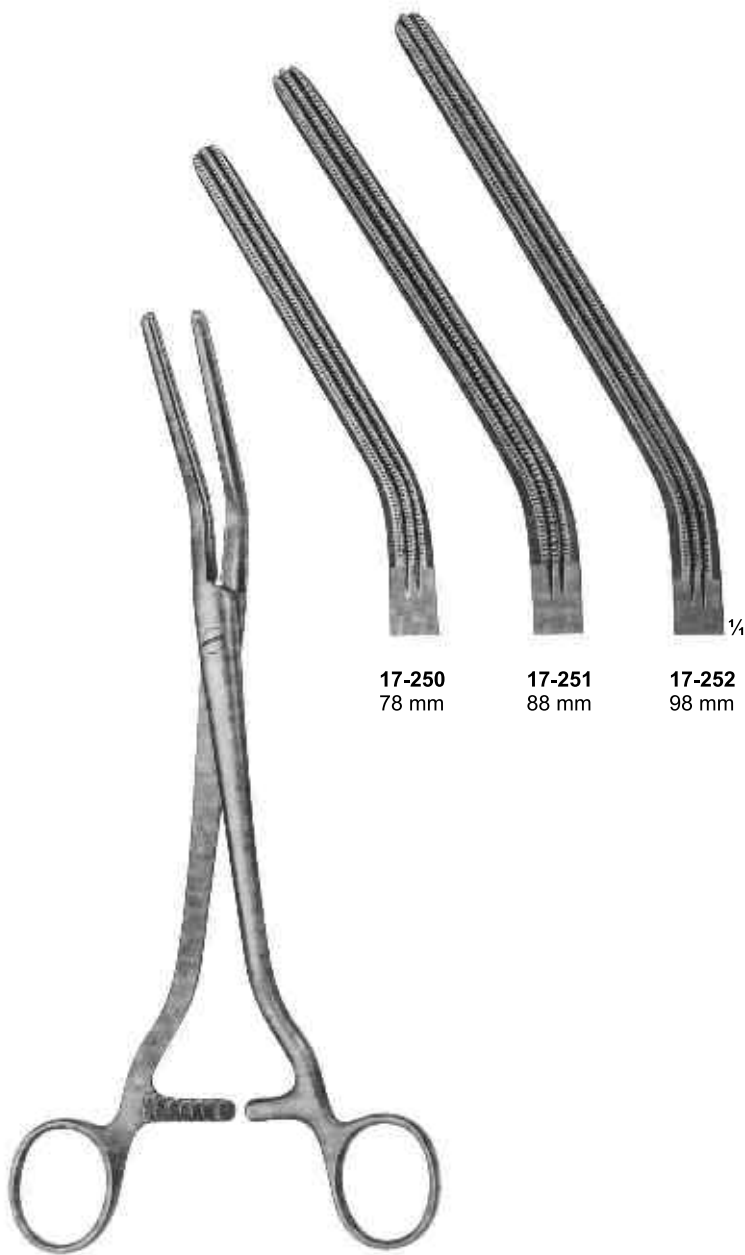

**17-250**  
78 mm

**17-251**  
88 mm

**17-252**  
98 mm

**17-250 - 252**  
DICK  
255 mm, 265 mm, 275 mm

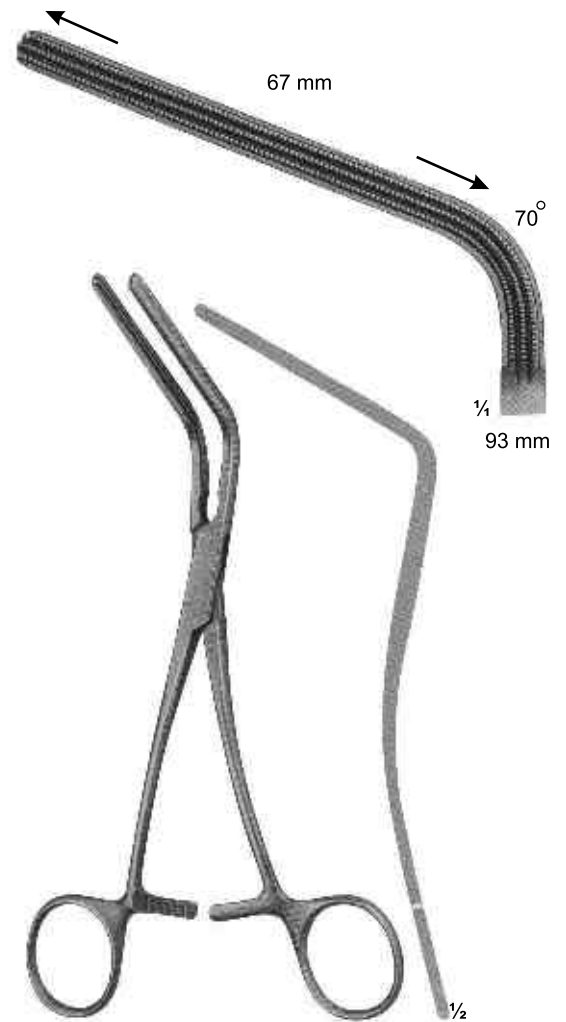

67 mm

70°

93 mm

**17-253**  
MORRIS  
175 mm

# Vena-Cava Clamps

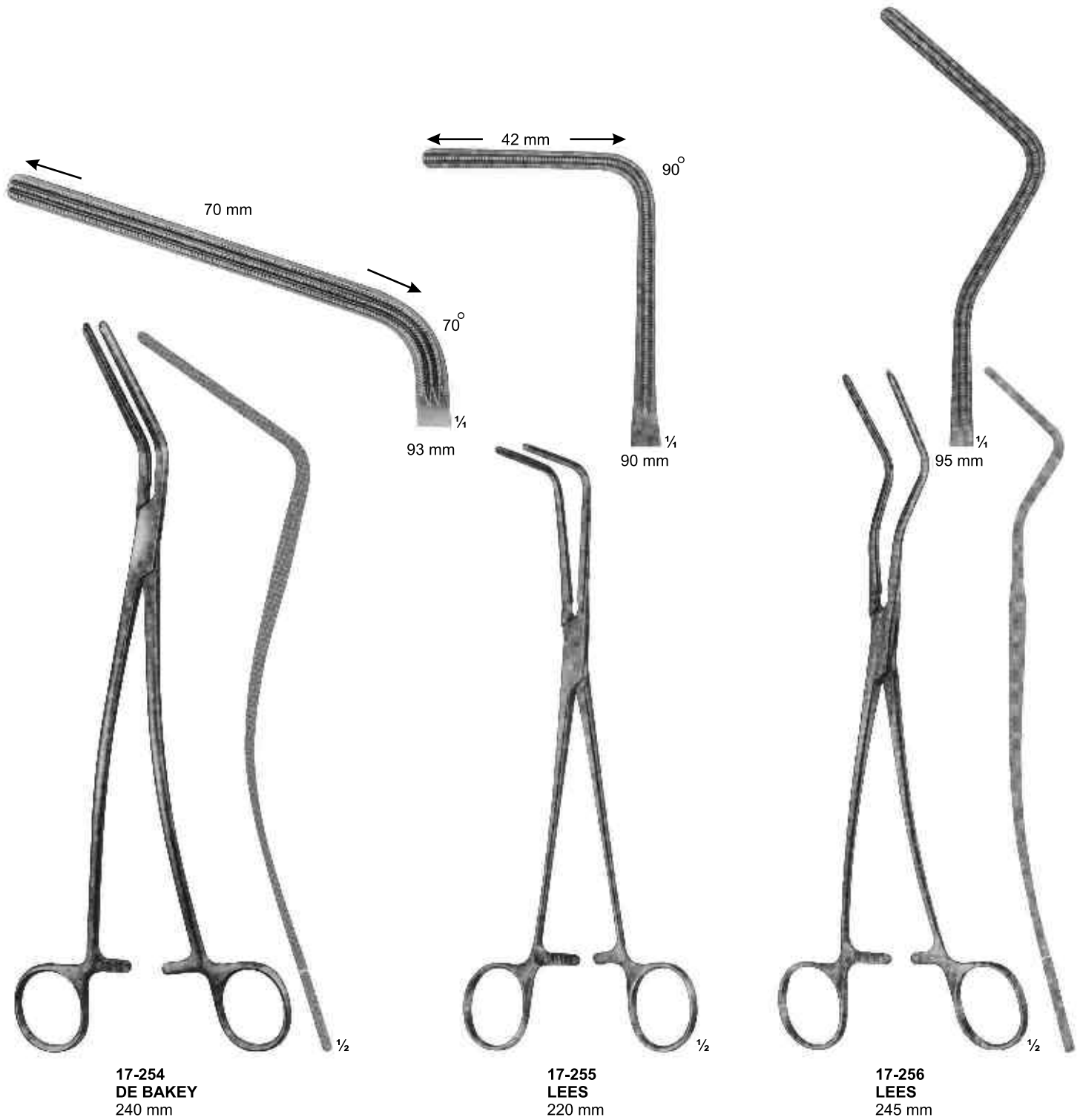

# Vena-Cava Clamps

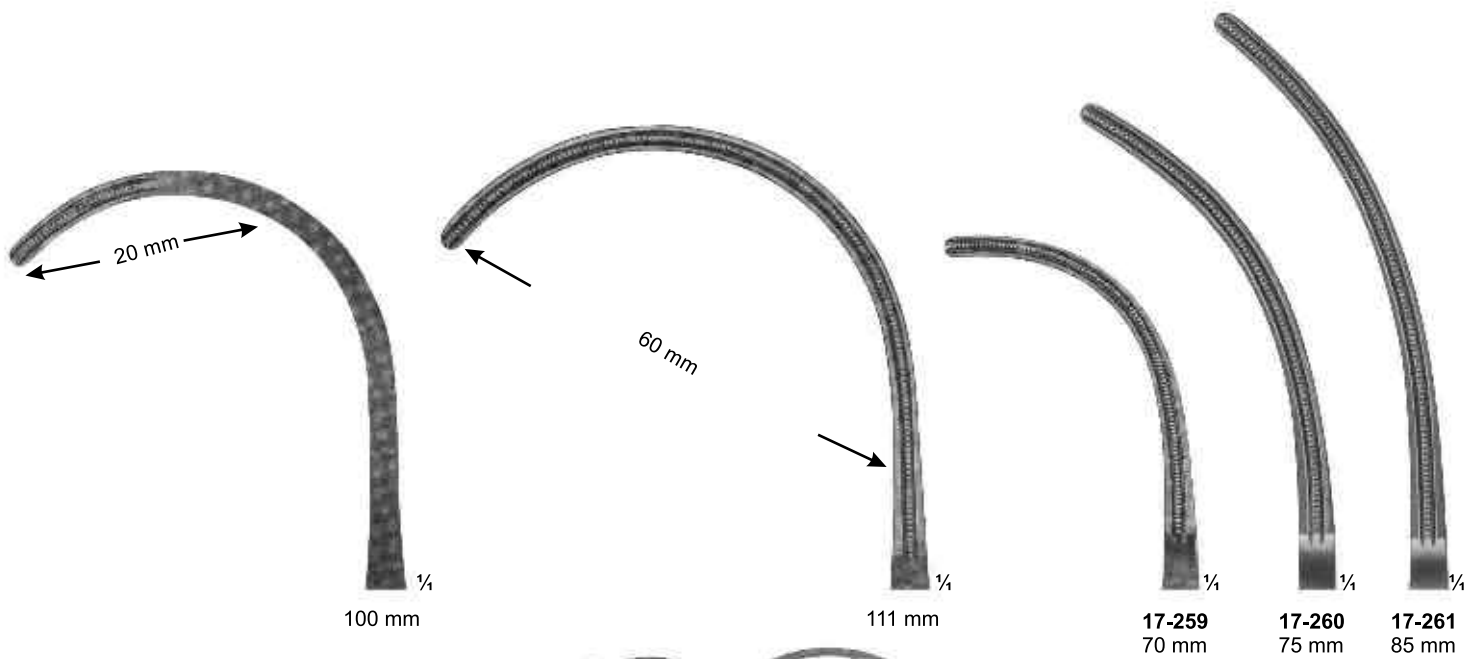

**17-257  
DE BAKEY**  
265 mm



**17-258  
DE BAKEY**  
270 mm

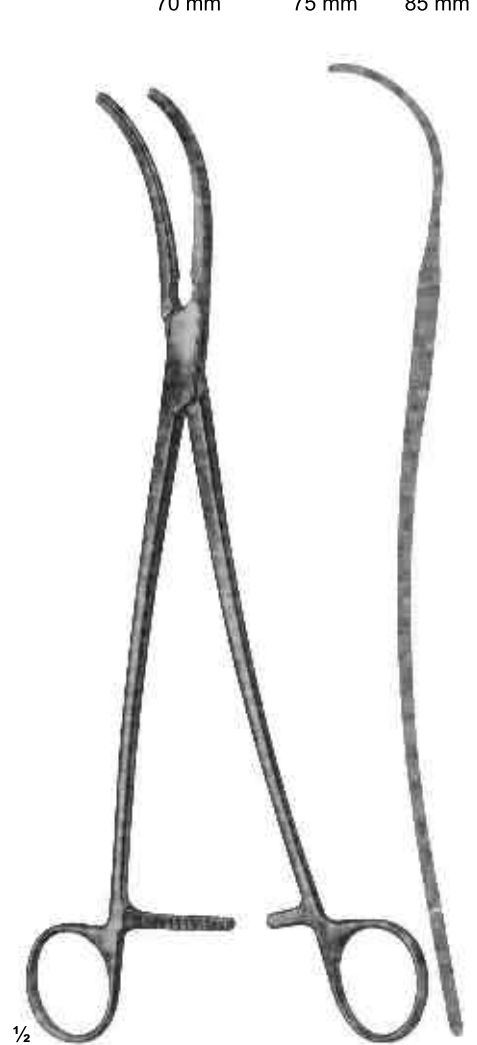

**17-259 - 261  
DE BAKEY**  
255 mm, 265 mm, 280 mm



# Vena-Cava Clamps

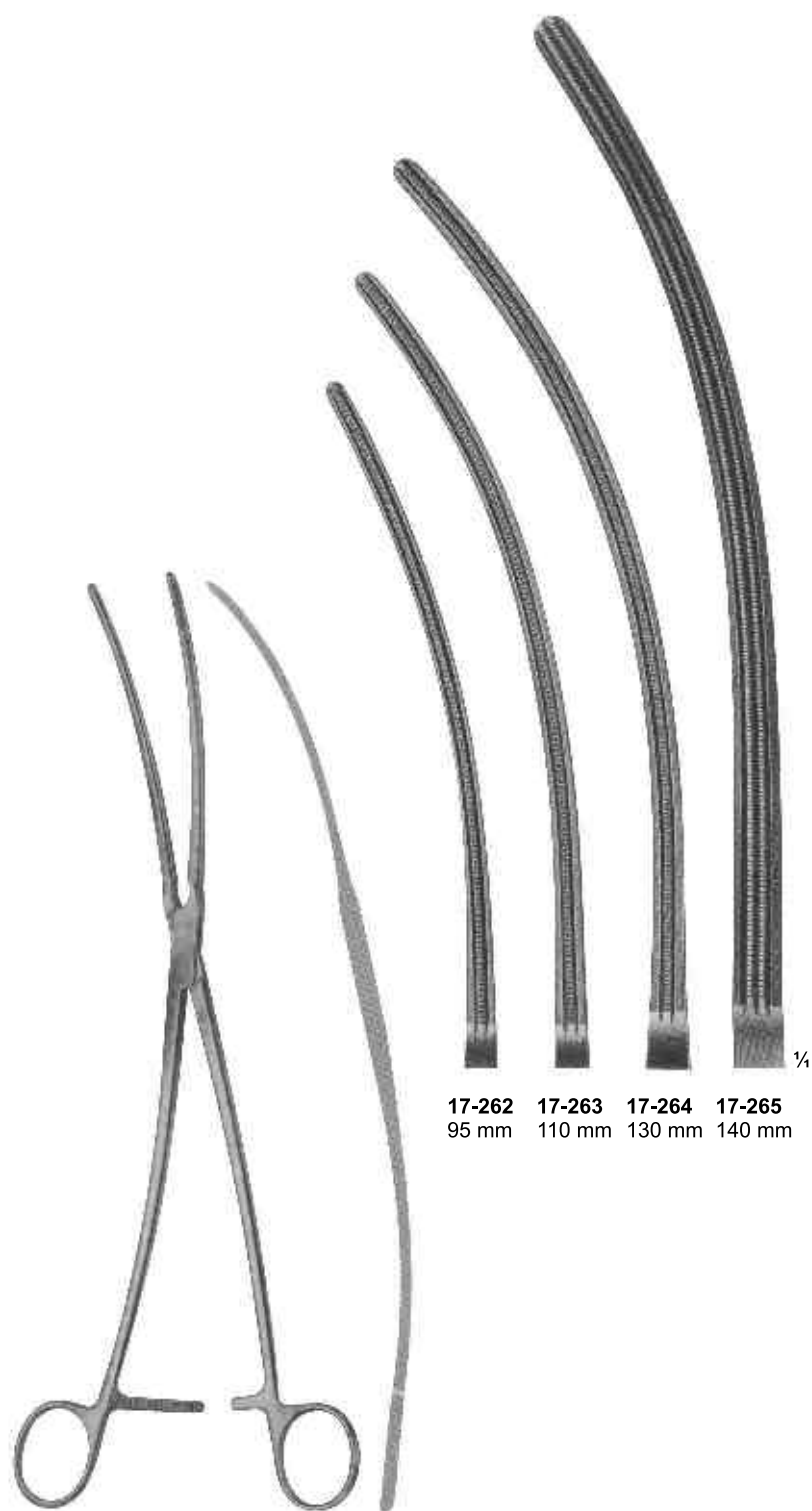

17-262 95 mm  
 17-263 110 mm  
 17-264 130 mm  
 17-265 140 mm

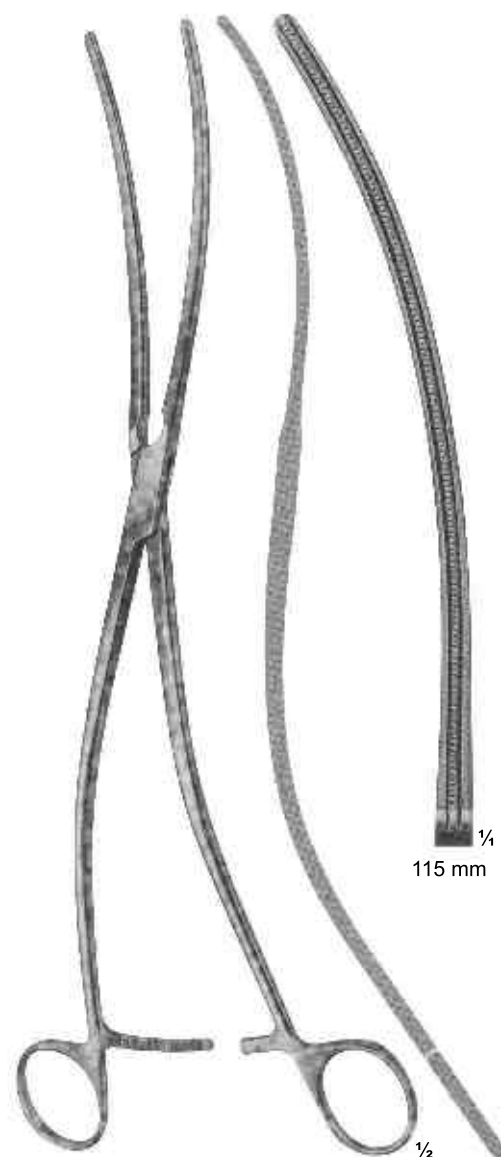

17-266  
 DE BAKEY  
 300 mm

17-262 - 265  
 DE BAKEY  
 250 mm, 300 mm,  
 315 mm, 330 mm

# Vena-Cava Clamps

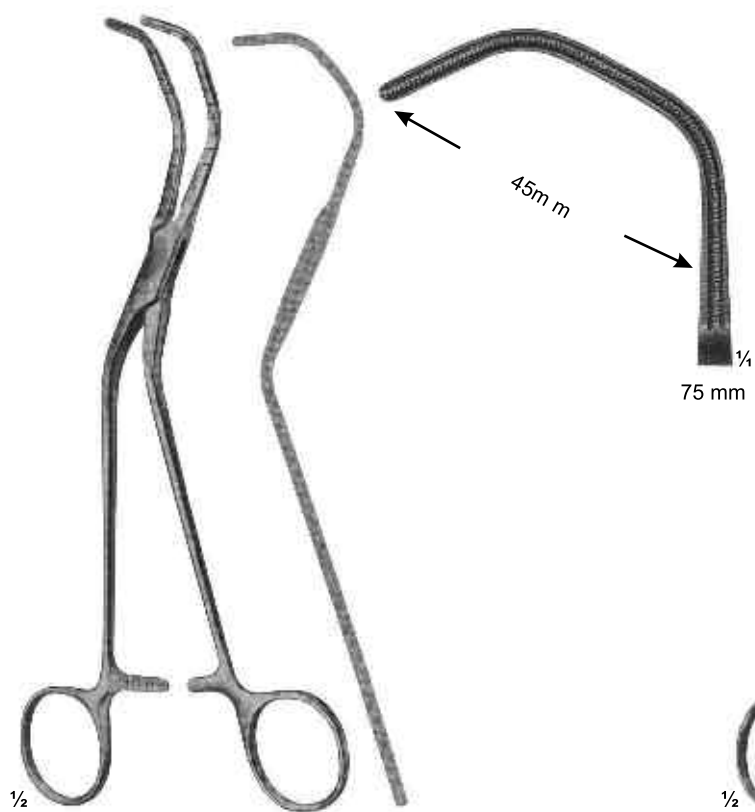

**17-267  
DIETRICH**  
210 mm

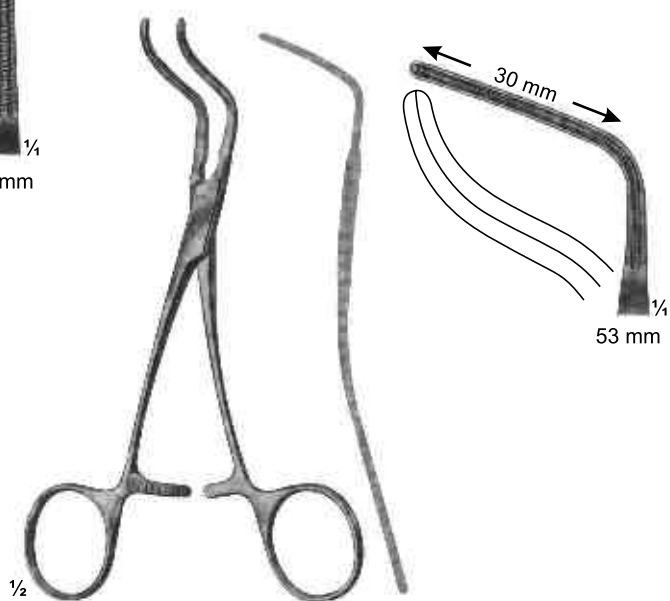

**17-268  
SUBRAMANIAN**  
155 mm



# Vena-Cava Clamps

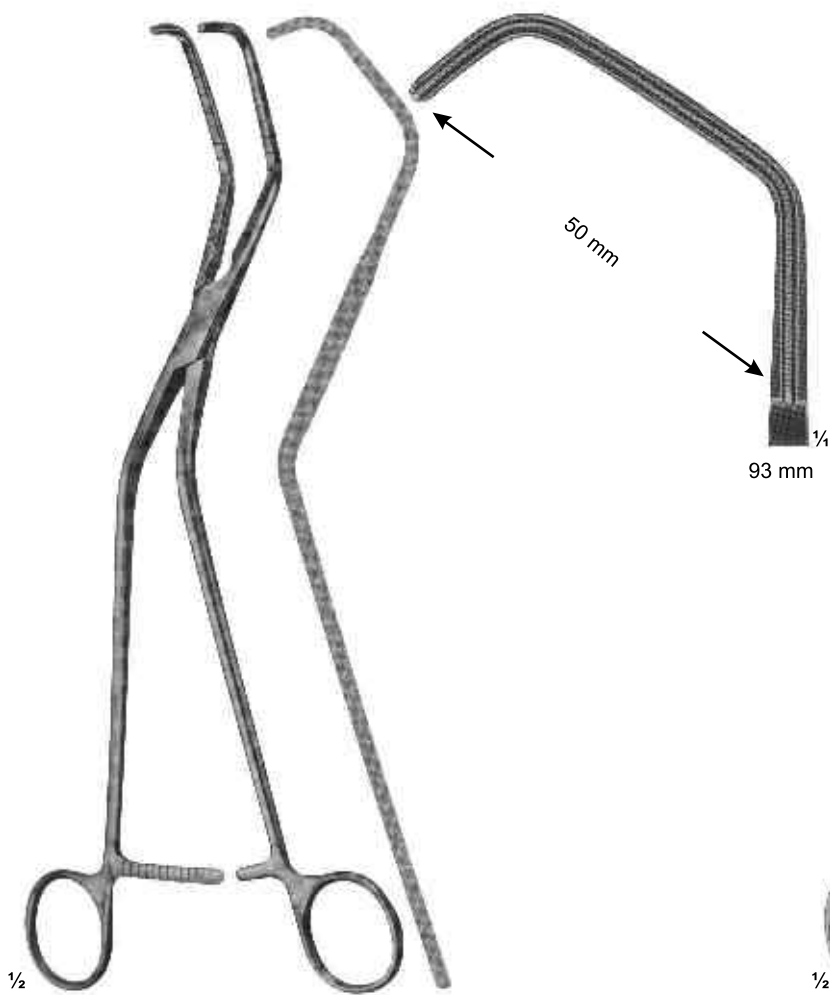

**17-269**  
**OCHSNER**  
260 mm

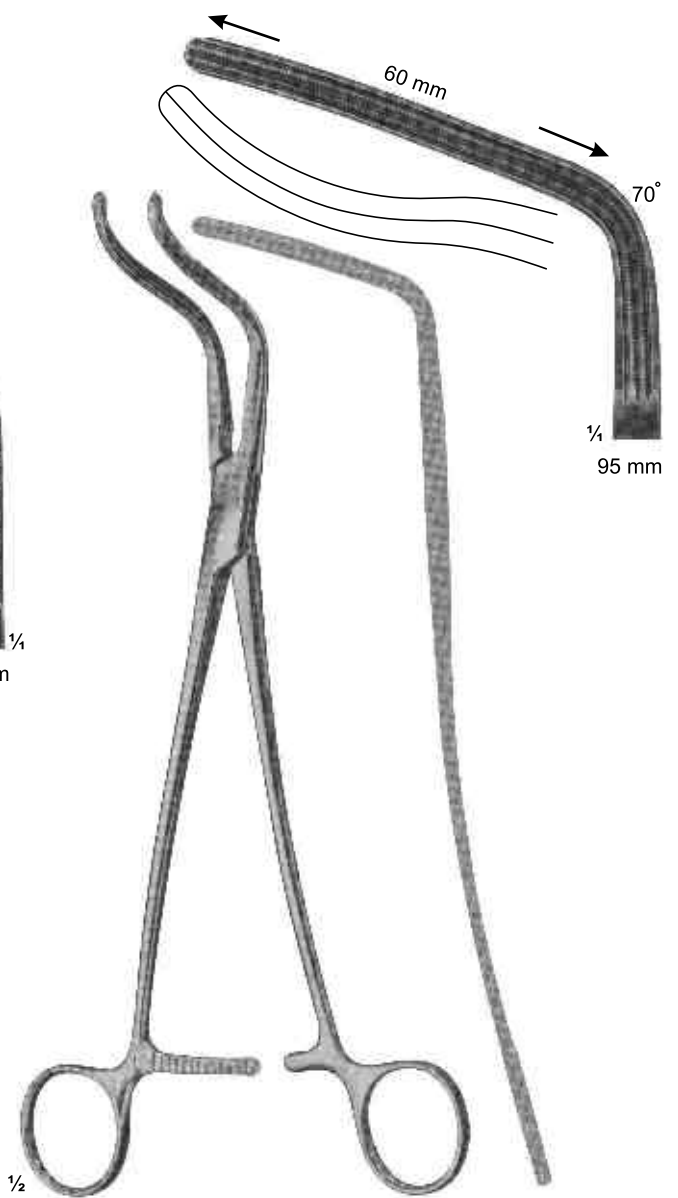

**17-270**  
**DE BAKEY**  
265 mm

# Aorta-Anastomosis Clamps



**L**  
17-271  
WEBER  
265 mm

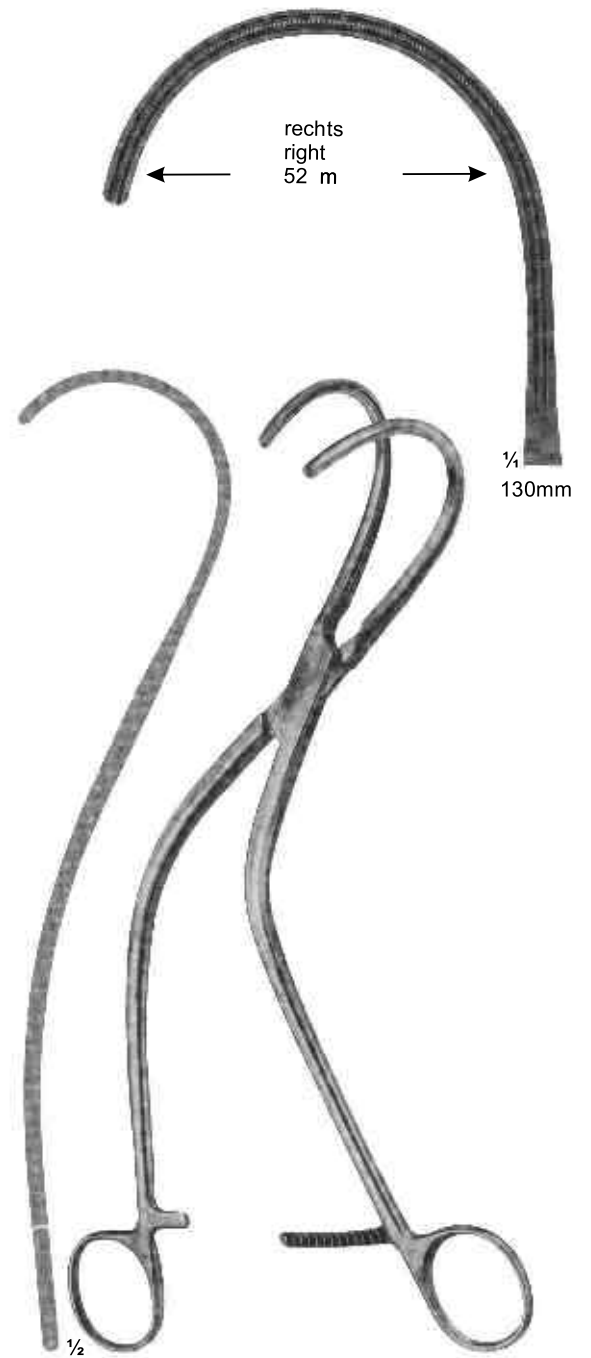

**R**  
17-272  
WEBER  
265 mm

# Aorta-Anastomosis Clamps



1/2

**17-273 - 276**  
DE BAKEY

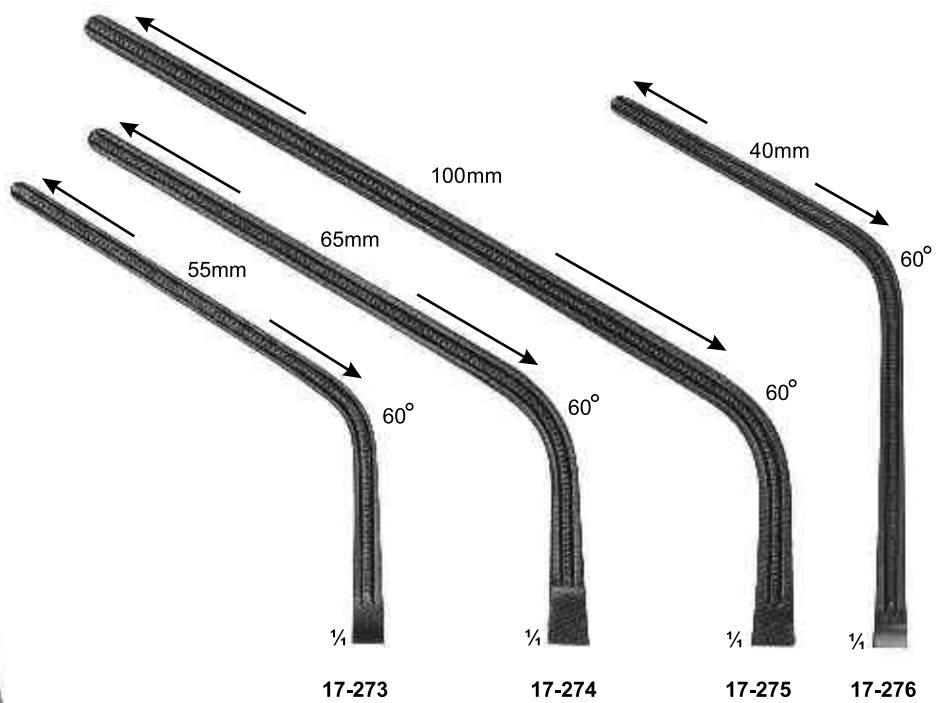

**17-273**

**17-274**

**17-275**

**17-276**

Total Length:	230 mm	280 mm	305 mm	240 mm
Length of jaws:	85 mm	100 mm	135 mm	93 mm

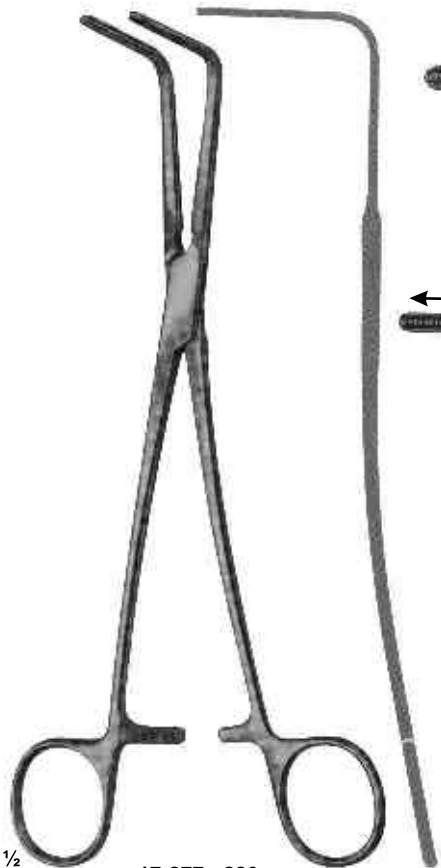

1/2

**17-277 - 280**  
DE BAKEY

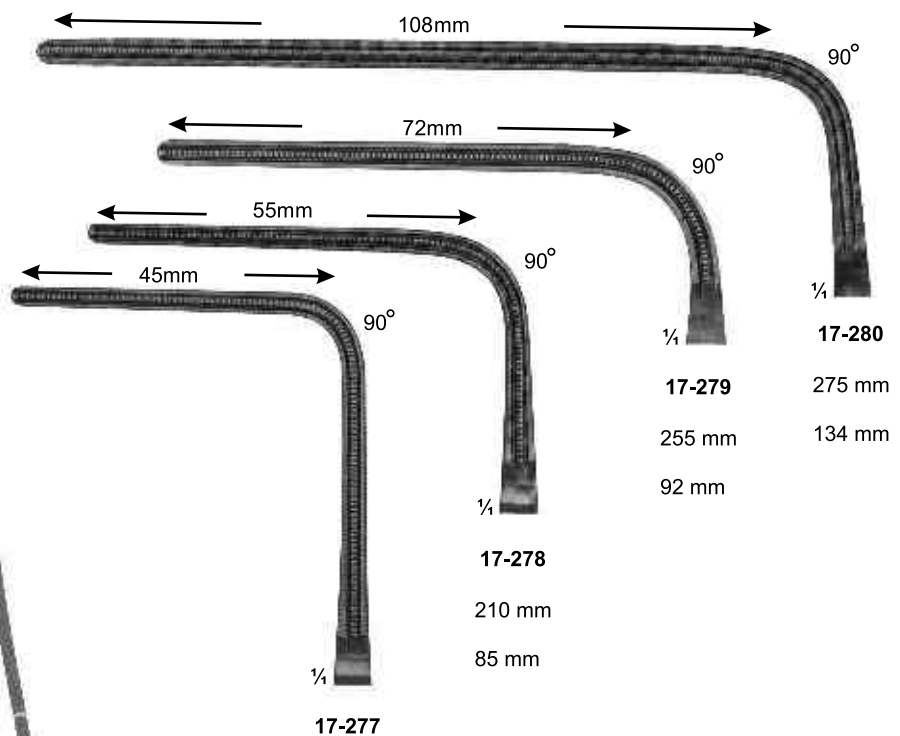

**17-278**

**17-277**

**17-279**

**17-280**

Total Length:	225 mm
Length of jaws:	93 mm

# Aorta-Anastomosis Clamps

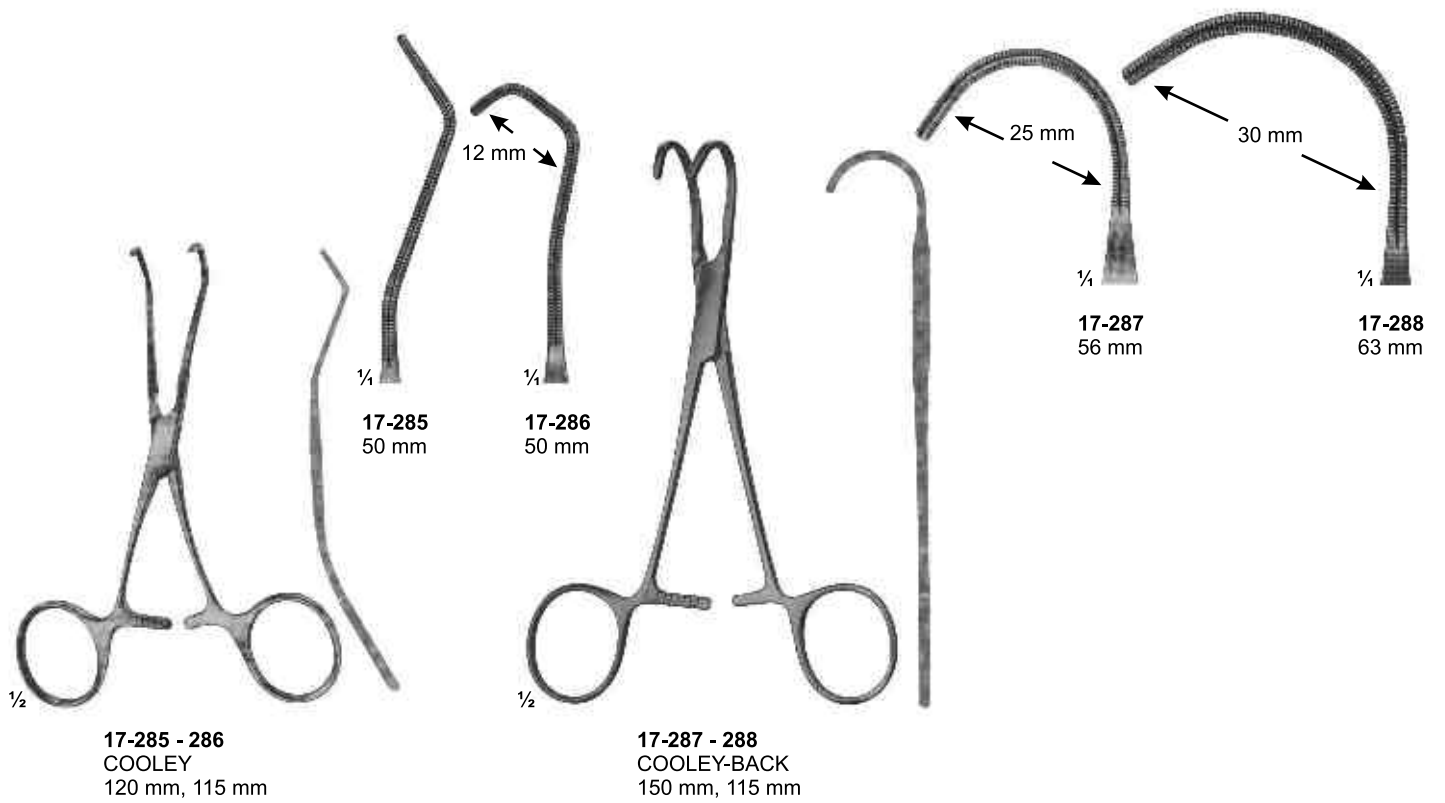
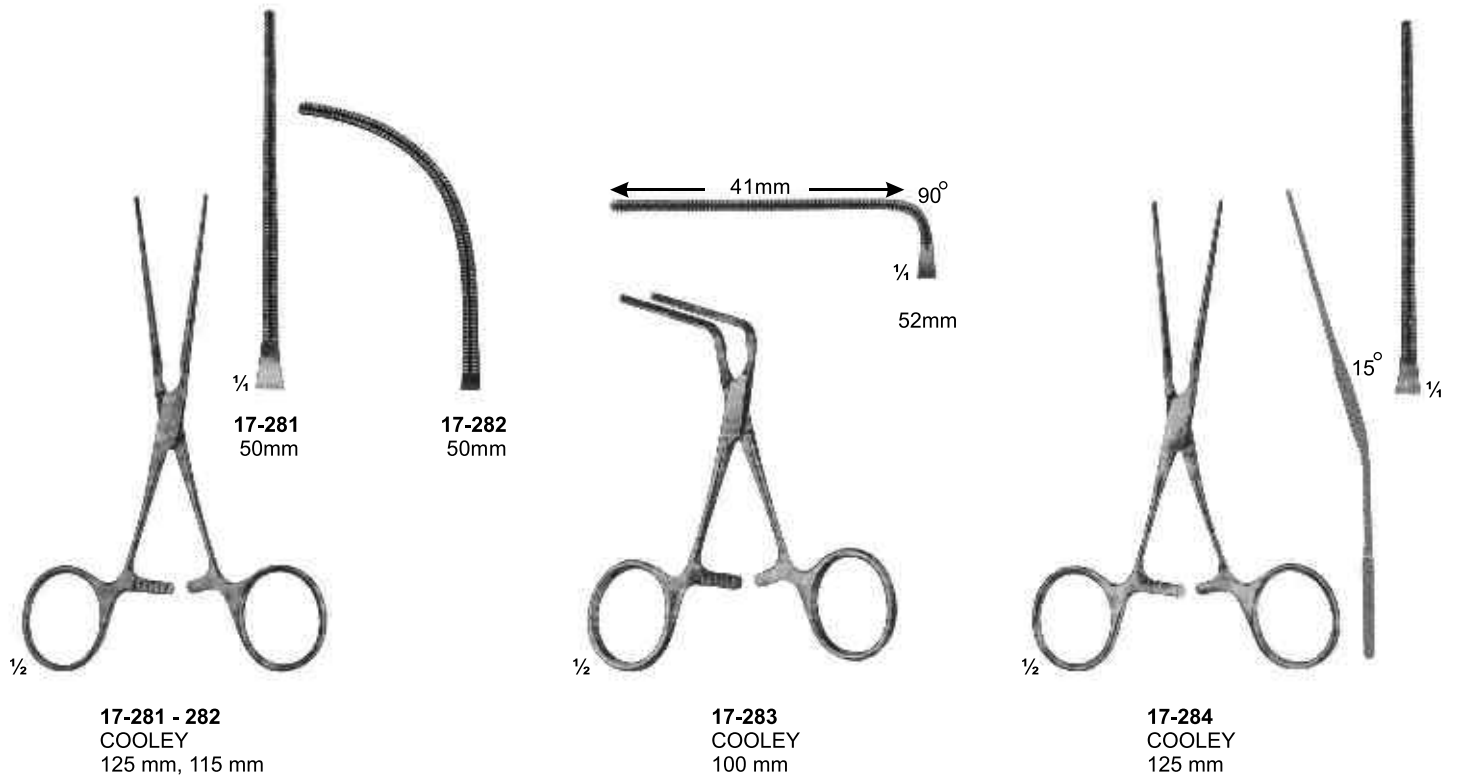

# Aorta-Anastomosis Clamps

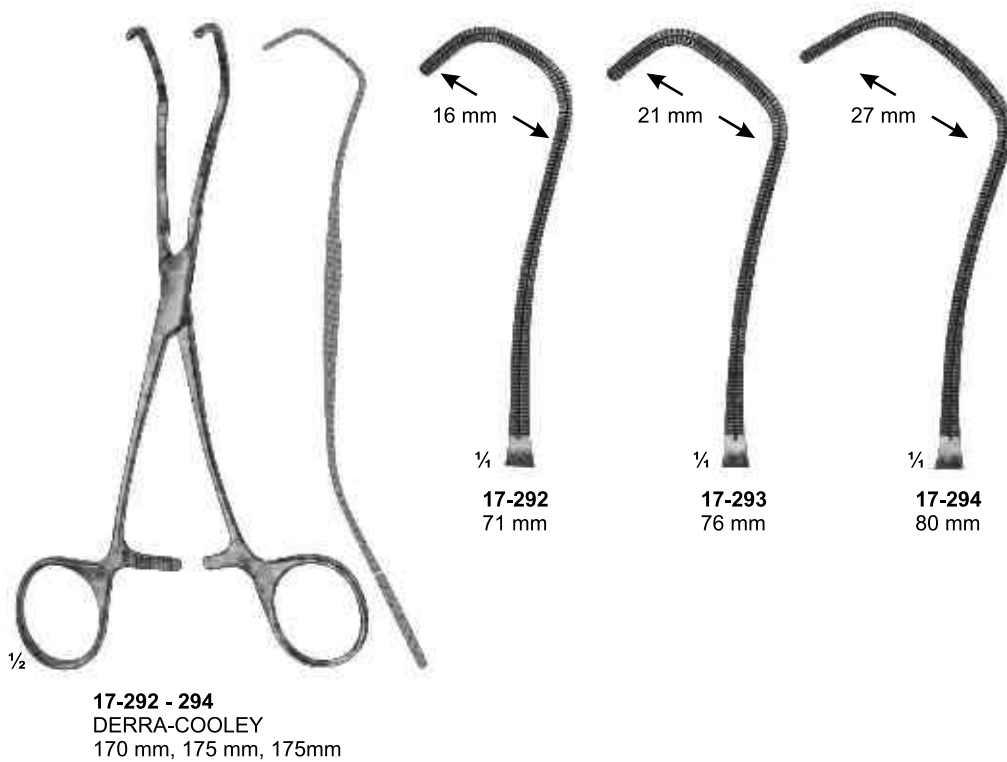
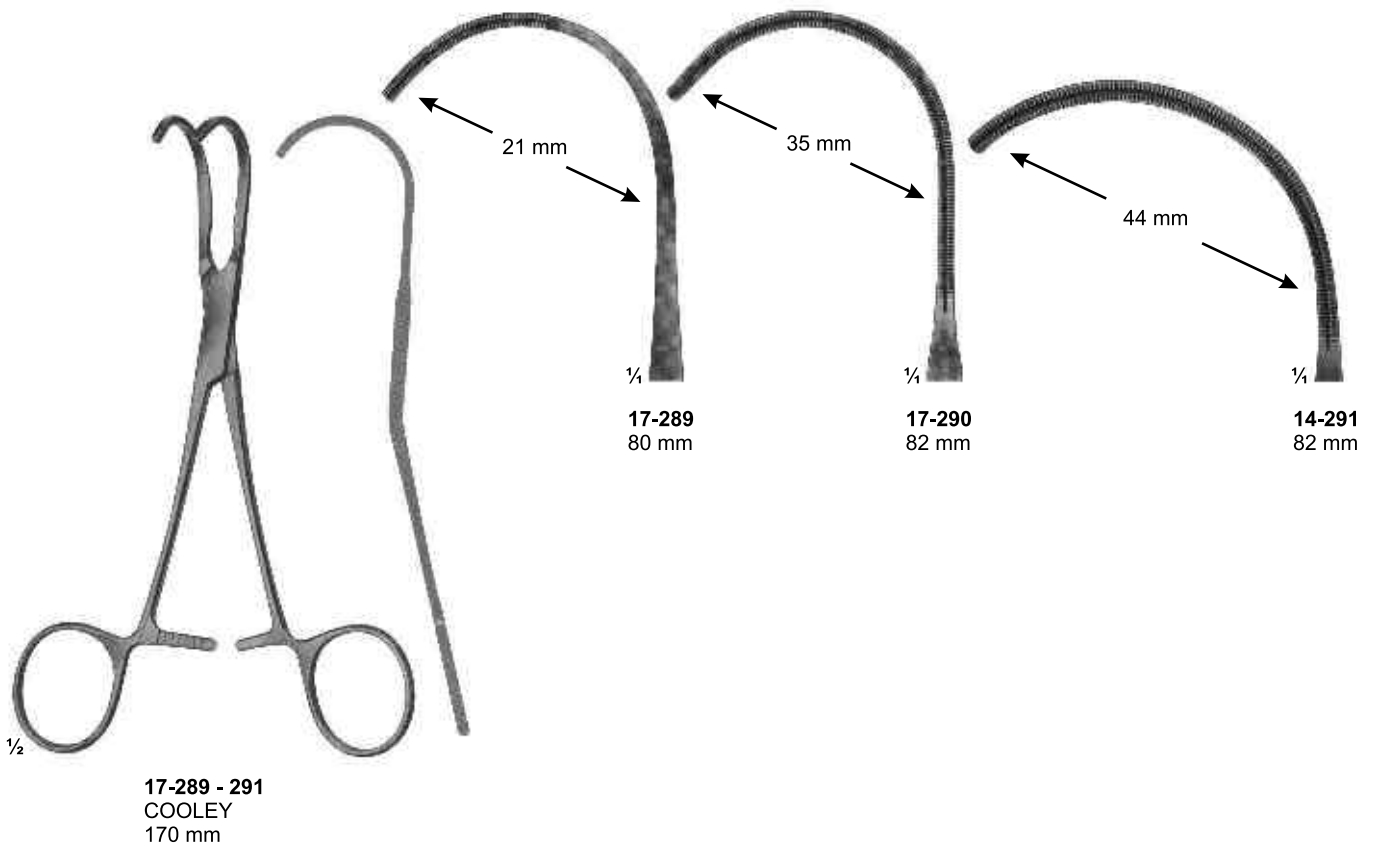

# Aorta-Anastomosis Clamps

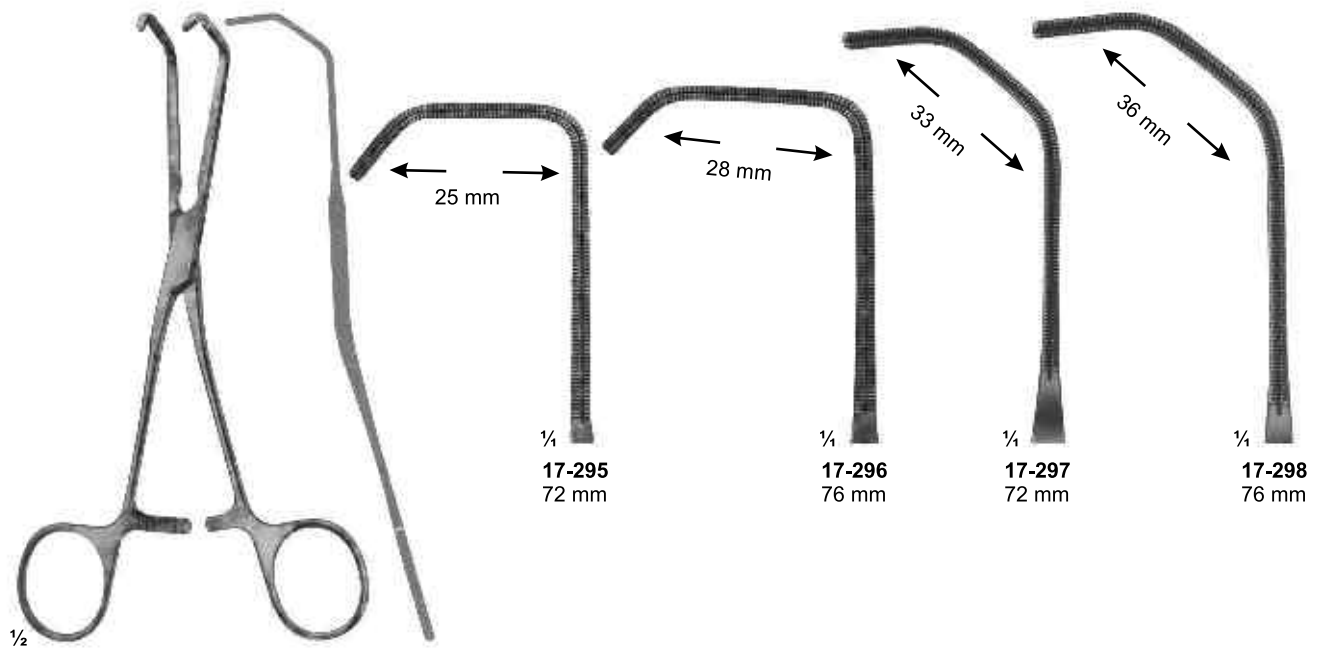

**17-295 - 298**  
COOLEY  
165 mm, 165 mm  
175 mm, 180 mm

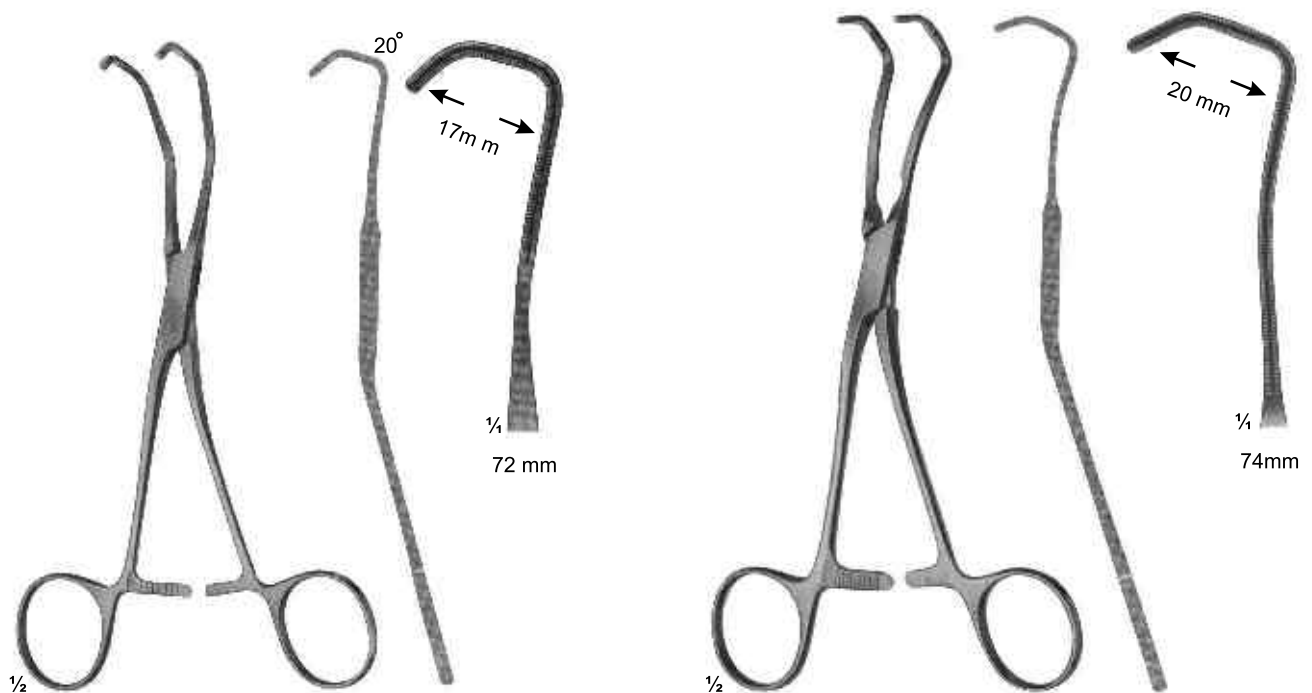

**17-299**  
COOLEY  
170 mm

**17-300**  
COOLEY  
175 mm



# Aorta-Anastomosis Clamps

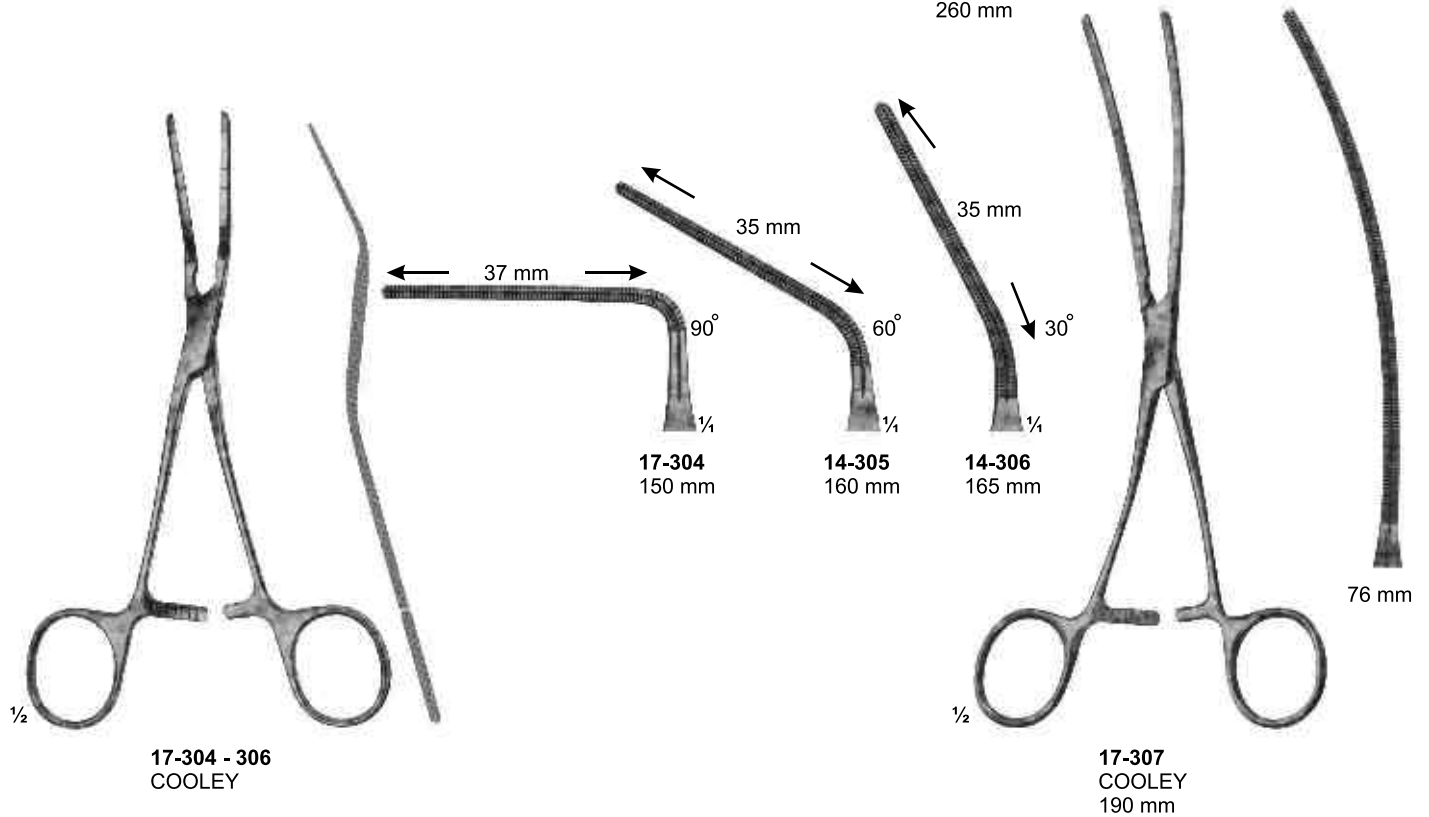
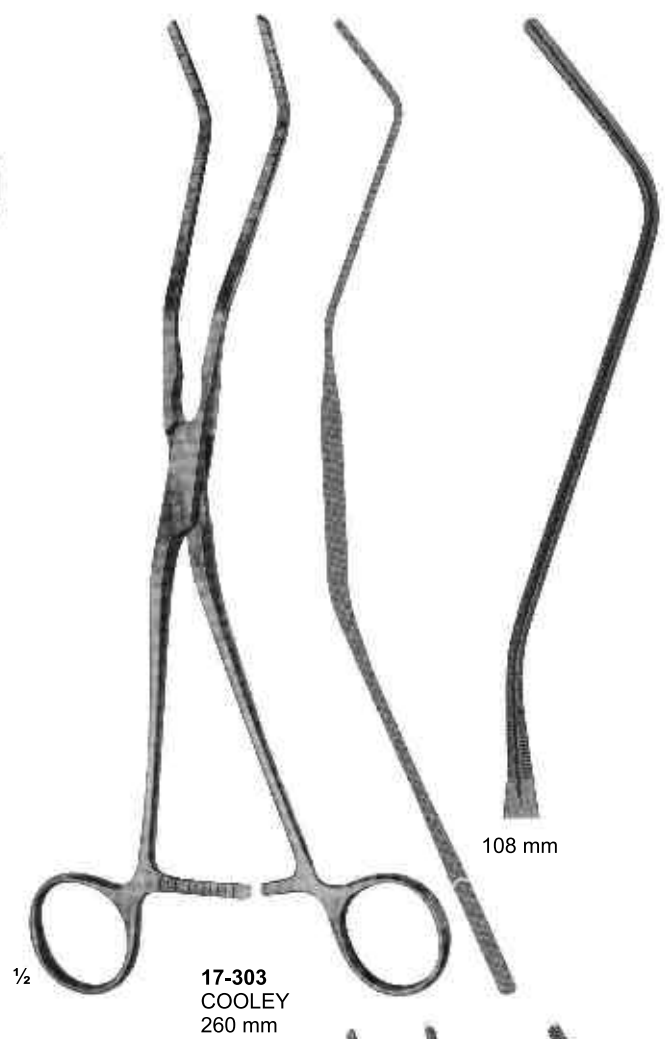
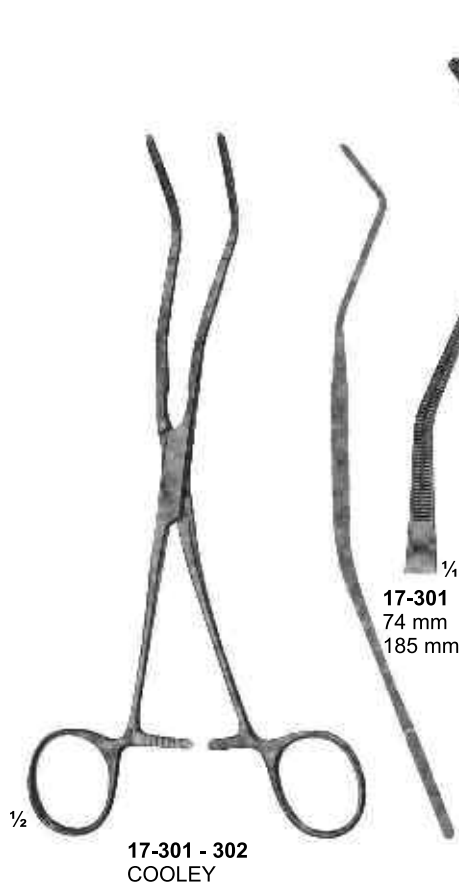

# Aorta-Anastomosis Clamps

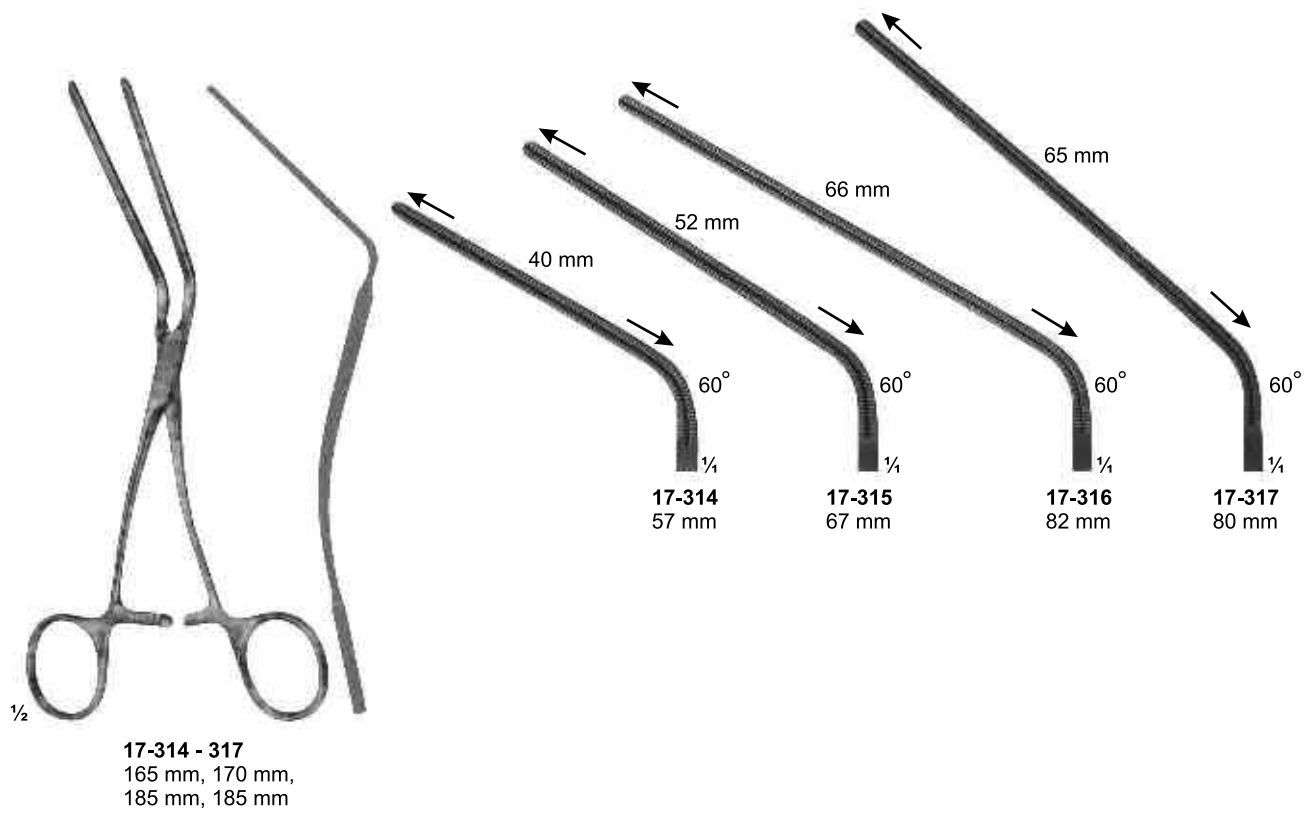
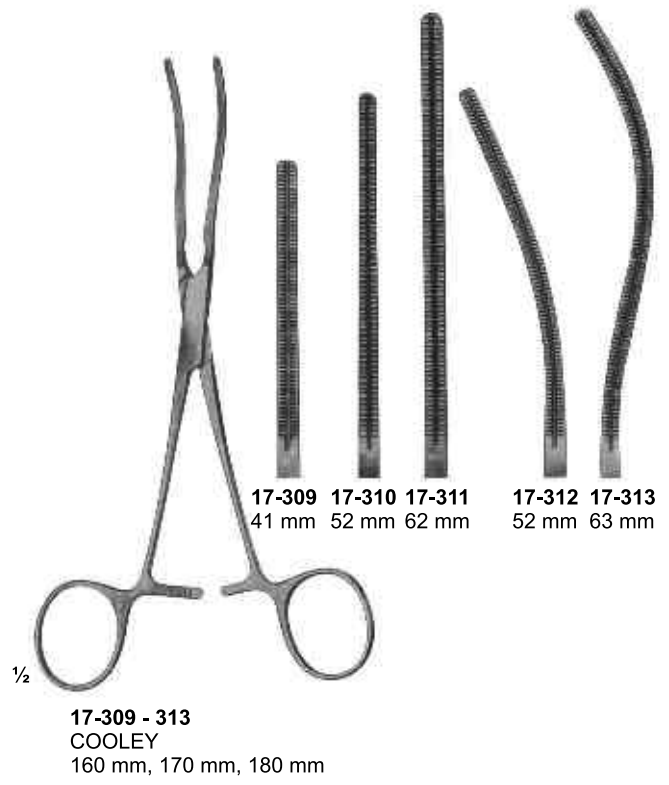
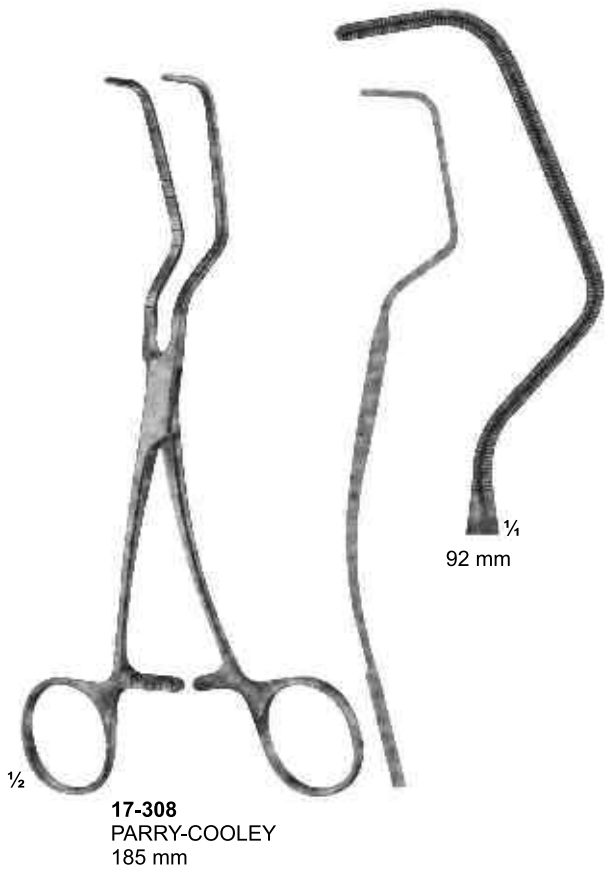



# Multi-Purpose Clamps



DARDIK  
 17-318 150 mm    17-323 170 mm  
 17-319 150 mm    17-324 170 mm  
 17-320 150 mm    17-325 170 mm  
 17-321 145 mm    17-326 160 mm  
 17-322 130 mm    17-327 135 mm

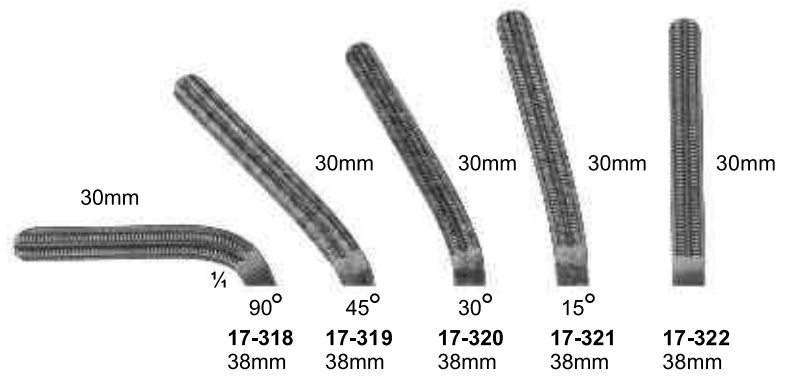

17-318 38mm    17-319 38mm    17-320 38mm    17-321 38mm    17-322 38mm

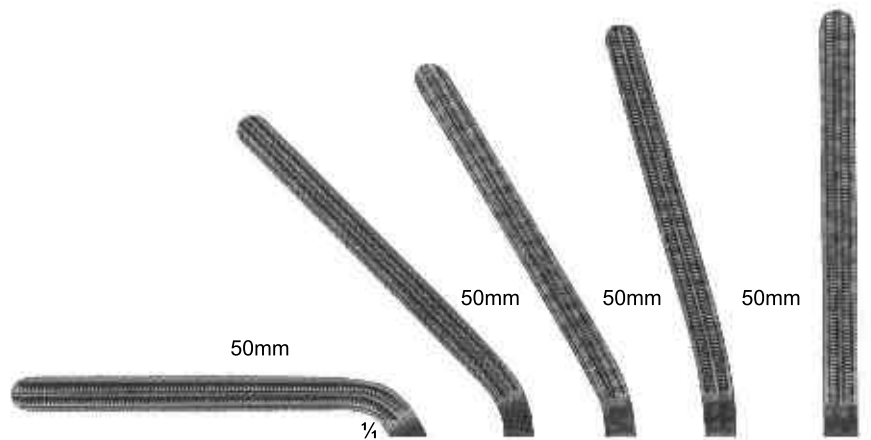

17-323 58mm    17-324 58mm    17-325 58mm    17-326 58mm    17-327 58mm

# Multi-Purpose Clamps

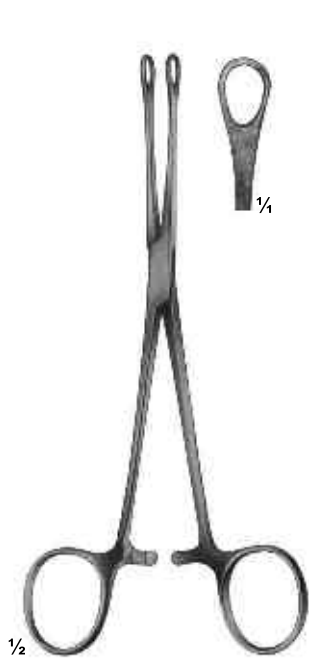

**17-328**  
WILLIAMS  
160 mm



**17-329**  
TUTTLE  
230 mm



**17-330**  
NELSON  
230 mm

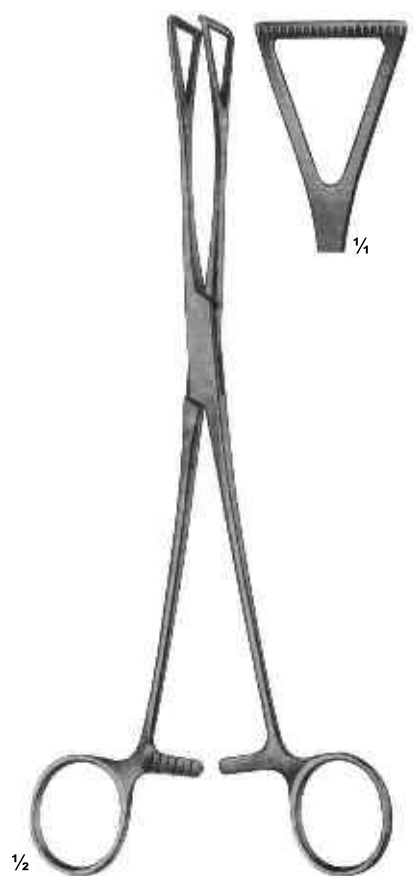

**17-331**  
DUVAL  
230 mm

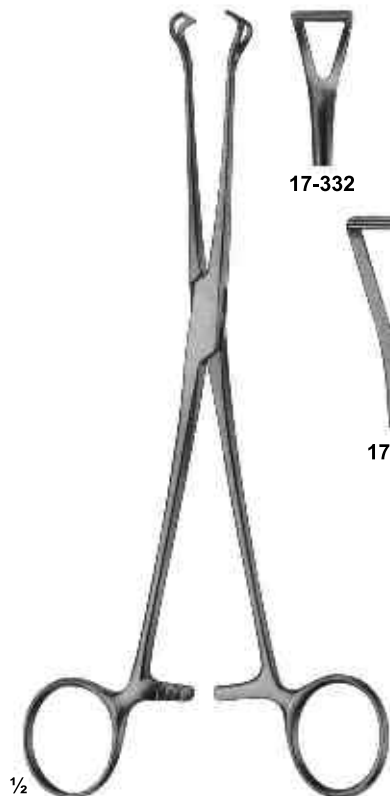

**BABCOCK**  
**17-332** 170 mm  
**17-333** 215 mm  
**17-334** 220 mm

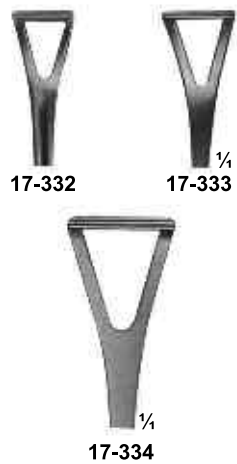

**17-335**  
ALLIS  
220 mm

# Multi-Purpose Clamps

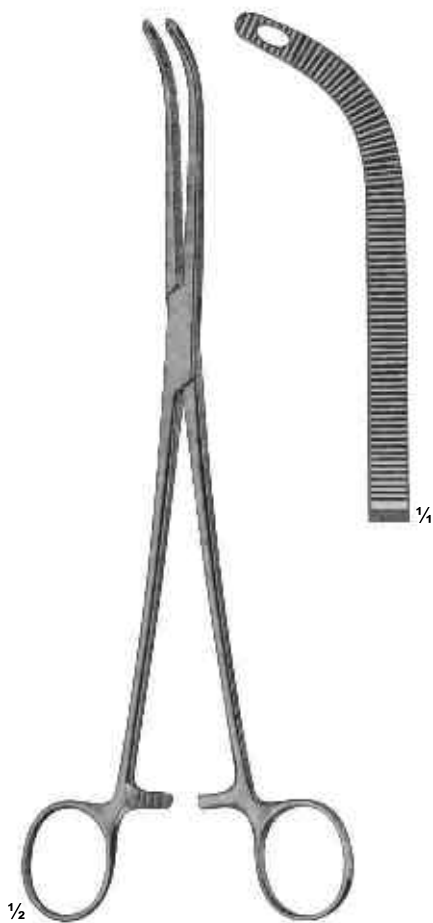

**17-336**  
**FINOCHIETTO**  
245 mm

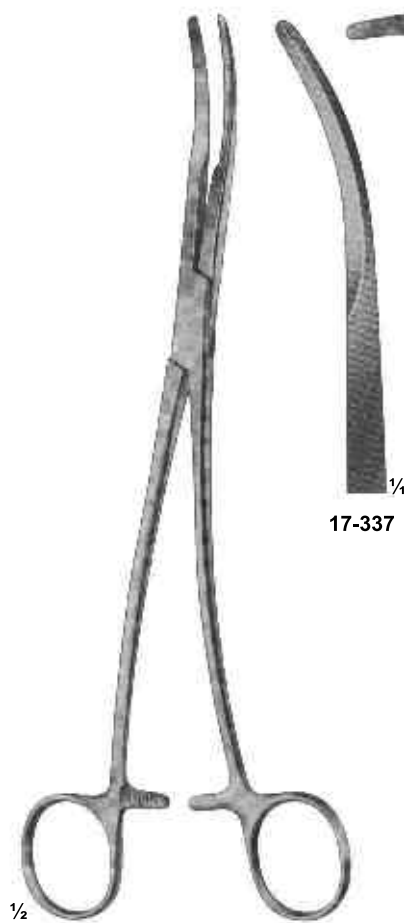

**17-337**

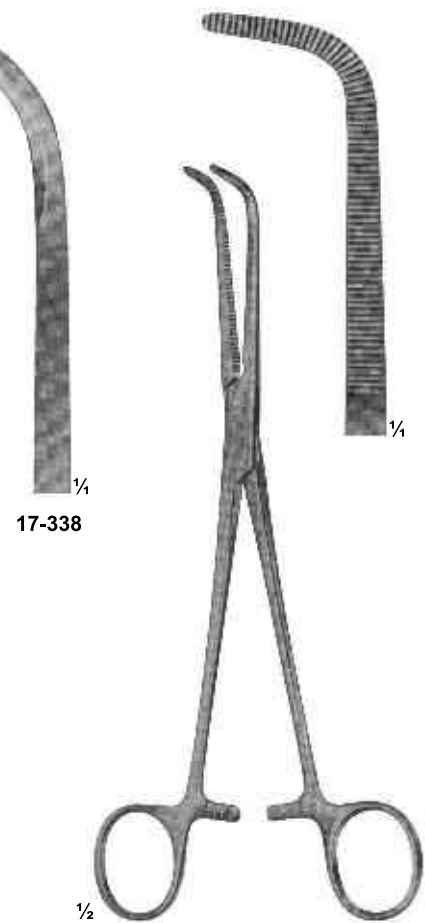

**17-338**

**17-339**  
**WIKSTROEM**  
205 mm

# Multi-Purpose Clamps



**17-340**  
MIXTER  
230 mm

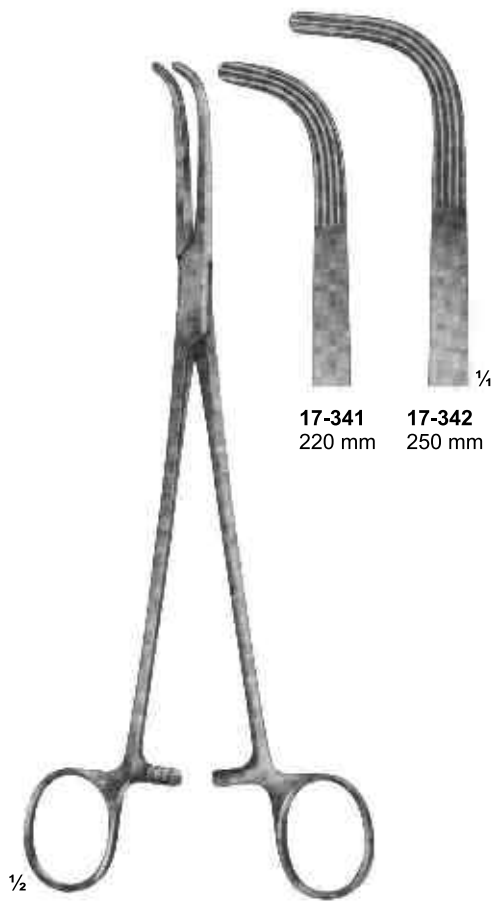

**17-341** 220 mm  
**17-342** 250 mm

**17-341 - 342**  
MIXTER

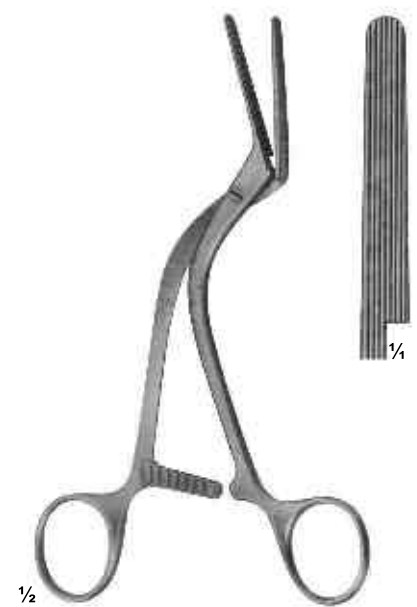

**17-343**  
HOPFNER  
160 mm

# Multi-Purpose Clamps

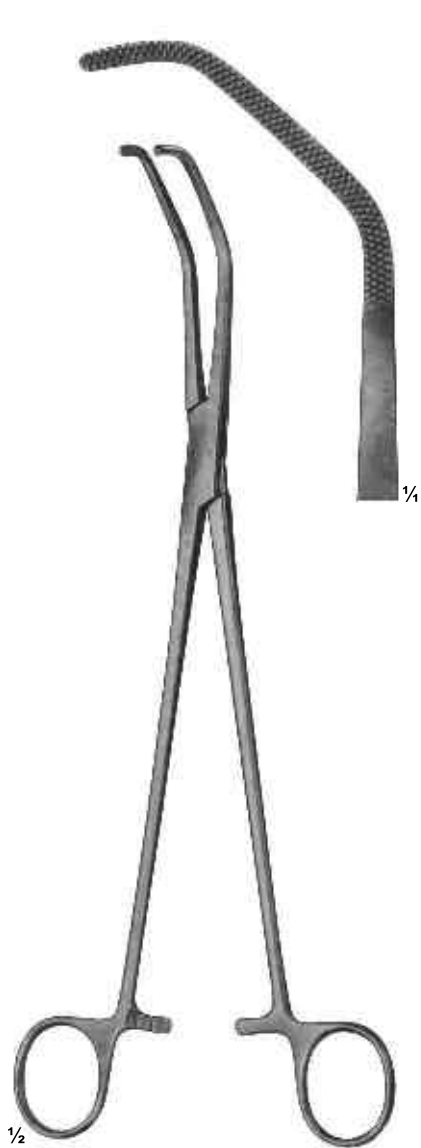

**17-344**  
SATINSKY  
265 mm



**17-345**  
SATINSKY  
265 mm

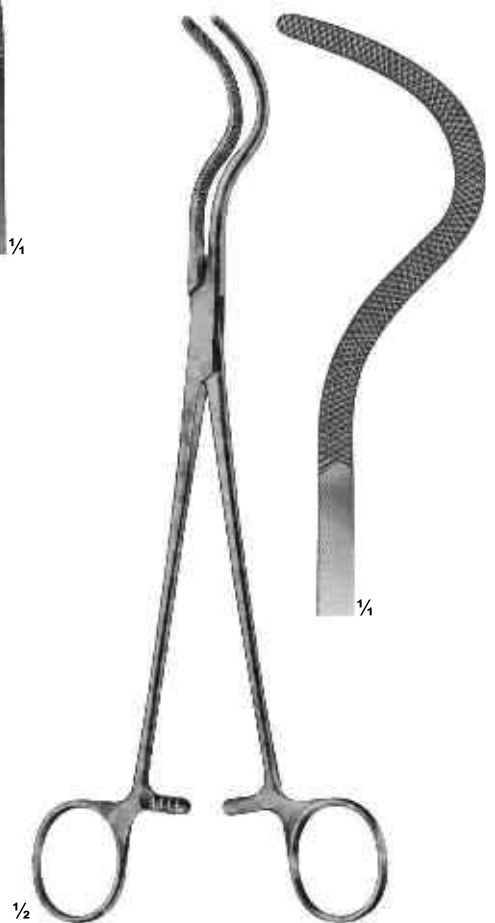

**17-346**  
HARKEN  
240 mm

# Multi-Purpose Clamps



**17-347**  
PERTUISET  
Carotid Clamp  
90 mm

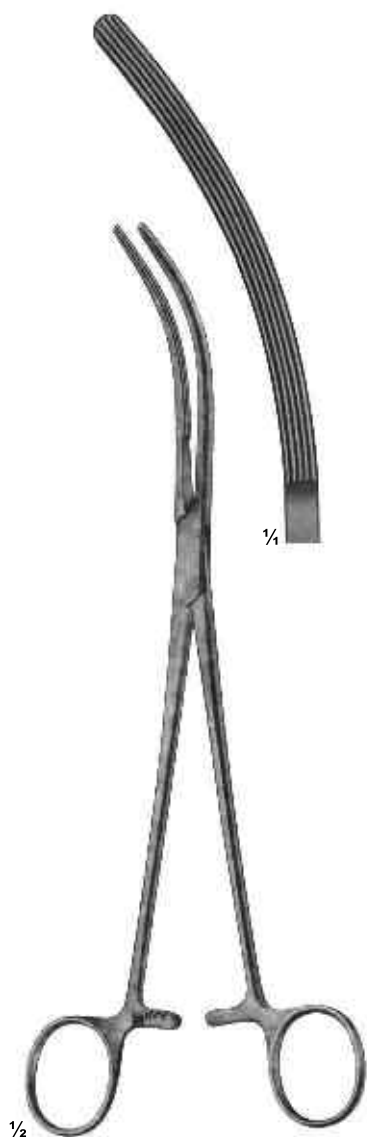

**17-348**  
CRAFOORD-SELLORS  
240 mm

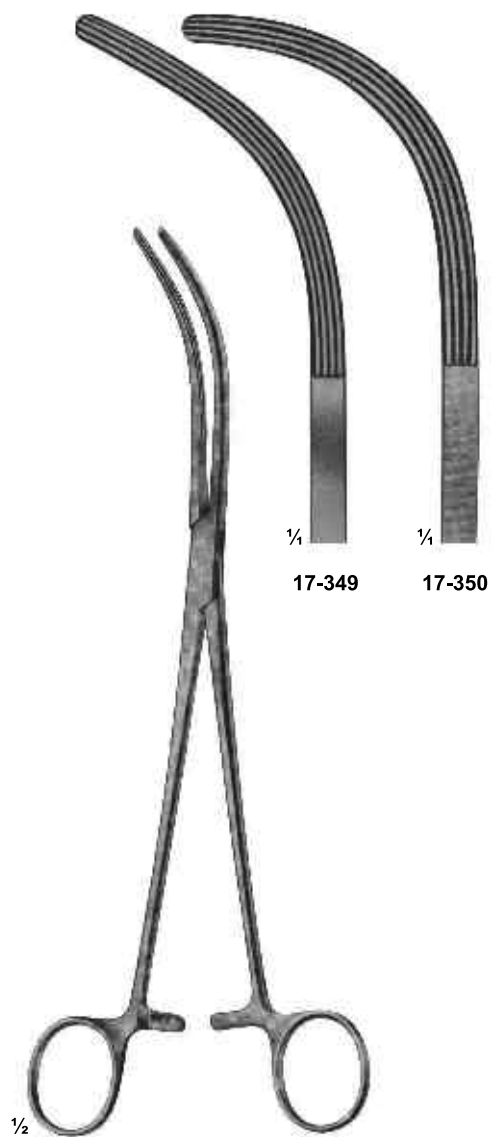

**17-349 - 350**  
CRAFOORD  
240 mm

# Multi-Purpose Clamps



**17-351**  
PRICE THOMAS  
225 mm

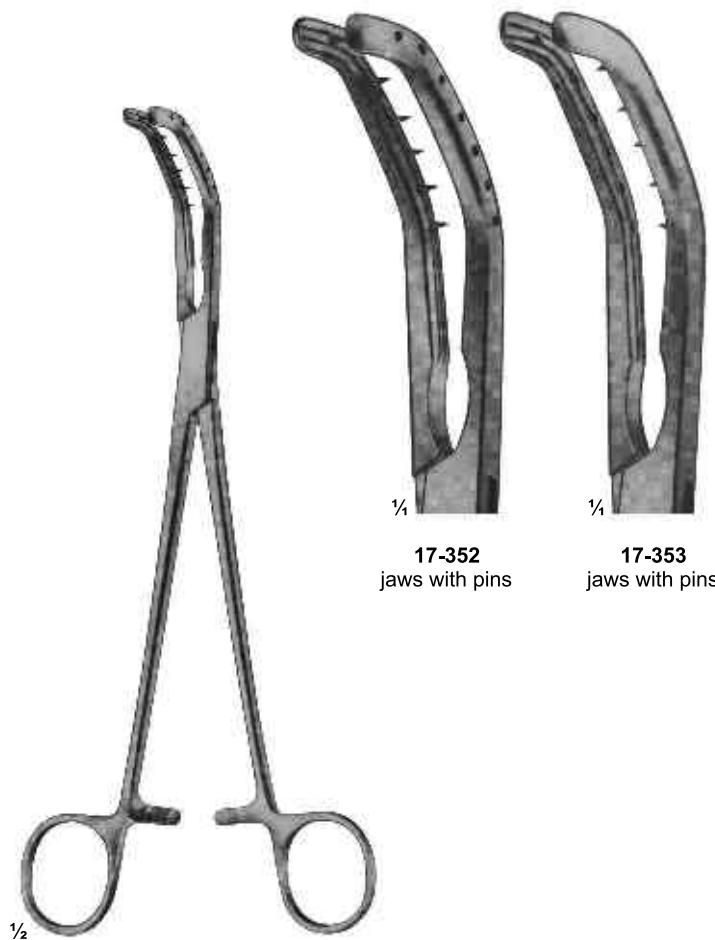

**17-352**  
jaws with pins

**17-353**  
jaws with pins

**17-352 - 353**  
PRICE THOMAS  
225 mm

# Rib Shears



**17-354**  
SCHUMACHER  
Sternum shears  
210 mm



**17-355**  
LEBSCHE  
Sternum chisel  
200 mm



**17-356**  
230 mm



**17-357**  
COLLIN  
195 mm



**17-358**  
GLUCK  
190 mm



**17-359**  
GLUCK  
190 mm

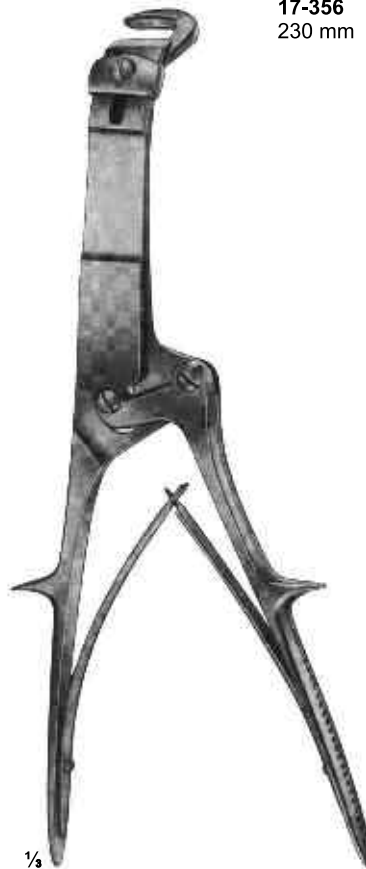

**17-360**  
BRUNNER  
Universal Pattern  
340 mm



**17-361**  
GIERTZ-STILLE  
250 mm



# Rib Holding Forceps, Bone Cutting Forceps

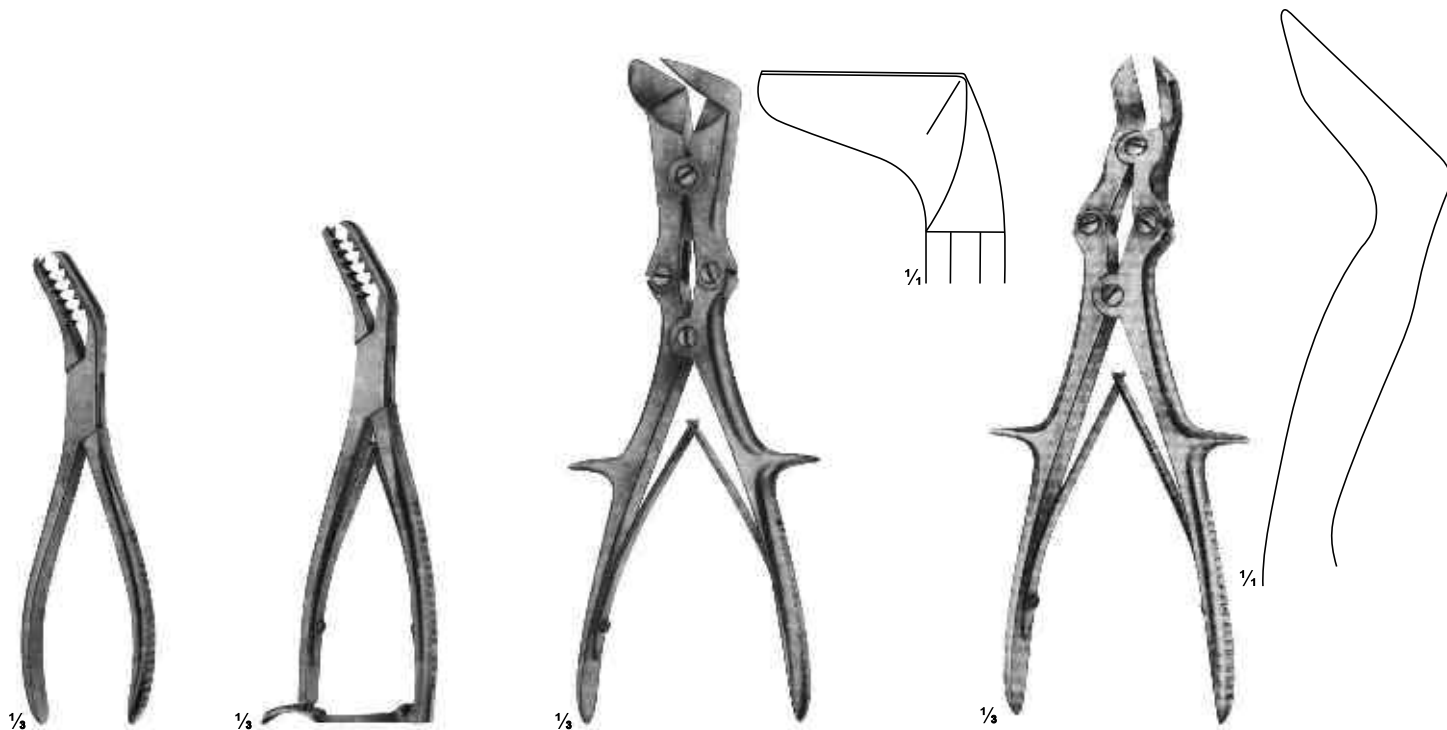

**17-362**  
SEMB  
Rib-and Bone  
Holding forceps  
190 mm

**17-363**  
SEMB  
Rib-and Bone  
Holding forceps  
190 mm

**17-364**  
LISTON-STILLE  
265 mm

**17-365**  
LISTON-KEY-HORSLEY  
255 mm

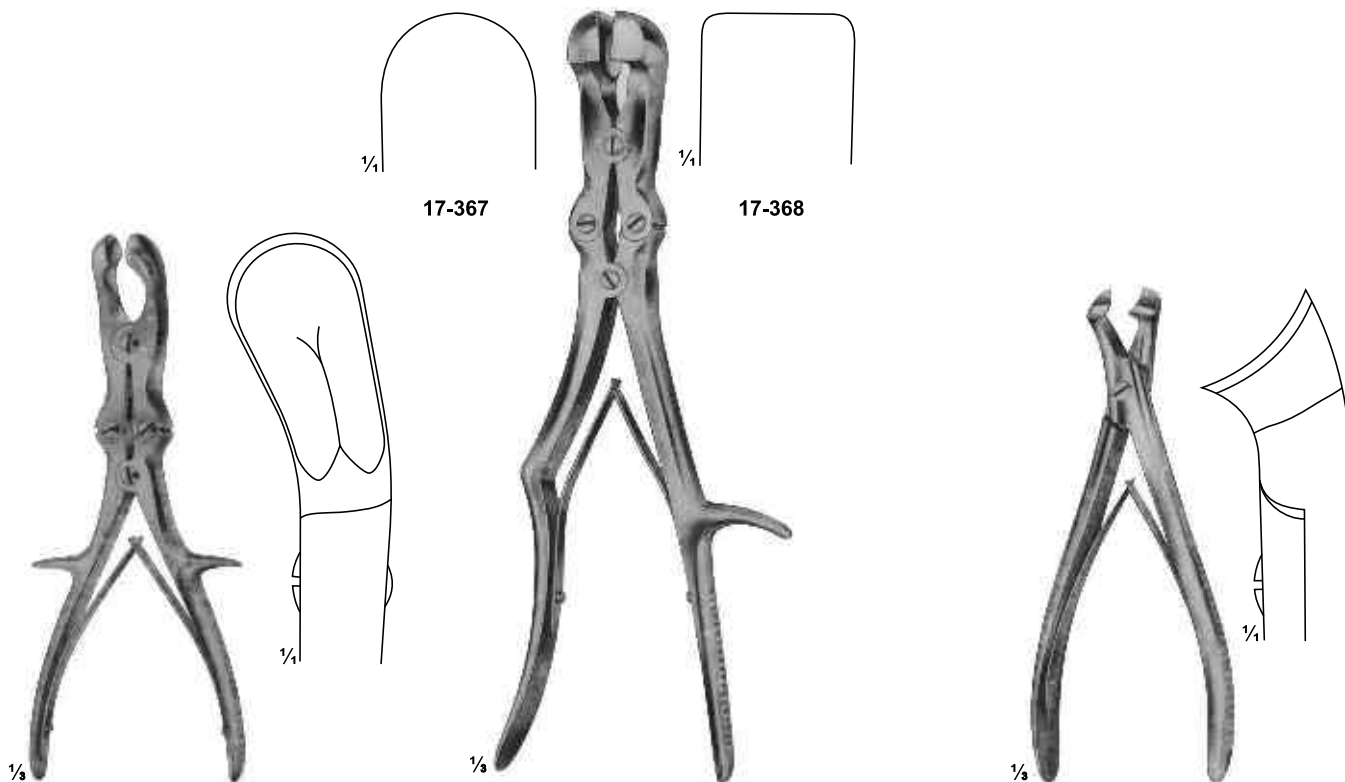

**17-366**  
SEME  
Rib Rongeur to shorten  
the rib stumps  
240 mm

**17-367-368**  
SAUERDRUCH-CORYLLOS  
Rib rongeurs to shortn  
the rib stumbe  
310 mm

**17-369**  
MARKWALDER  
Rib Rongeur to Round  
the rib stumps  
190 mm

# Rib Raspatories

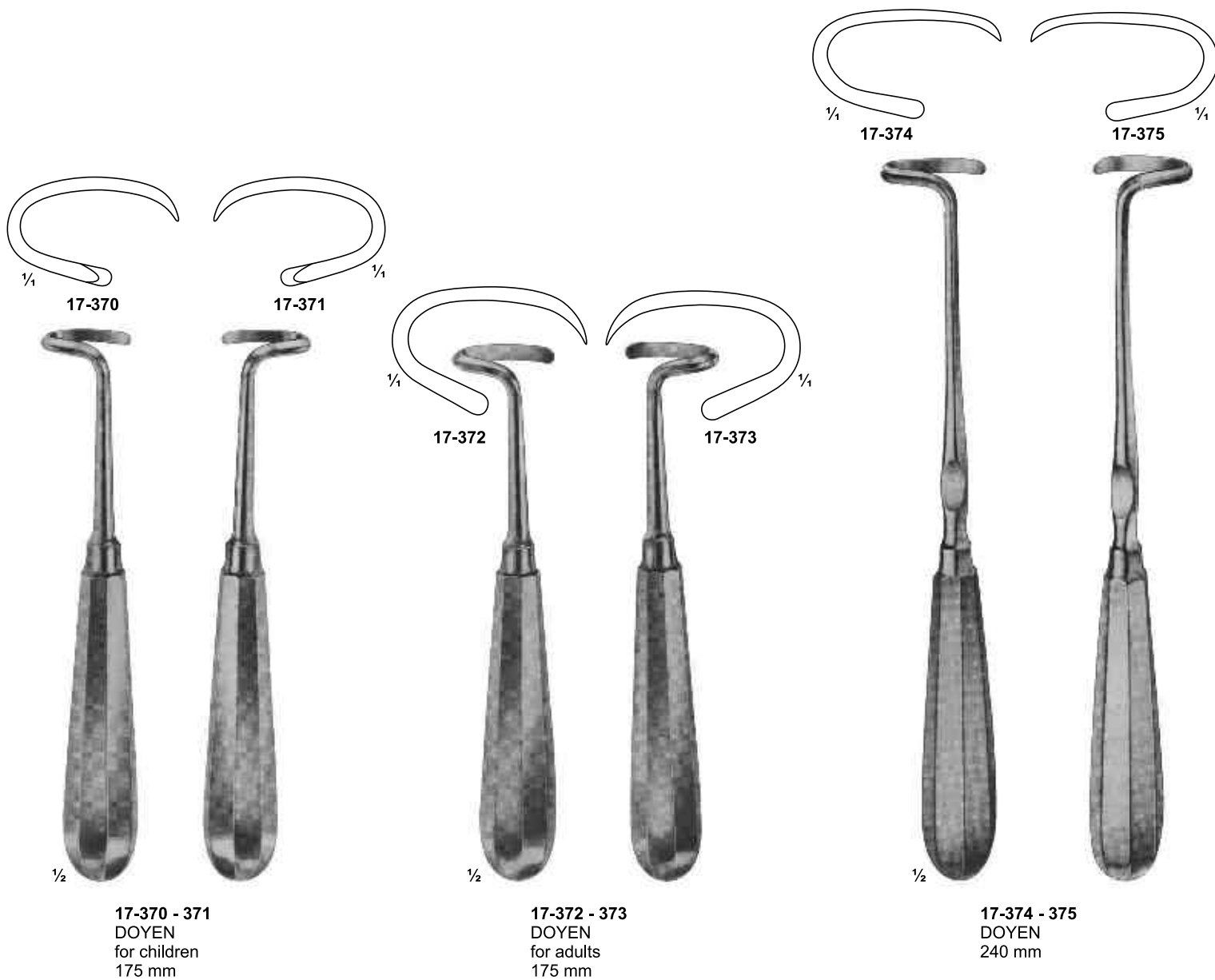

# Rib Raspatories

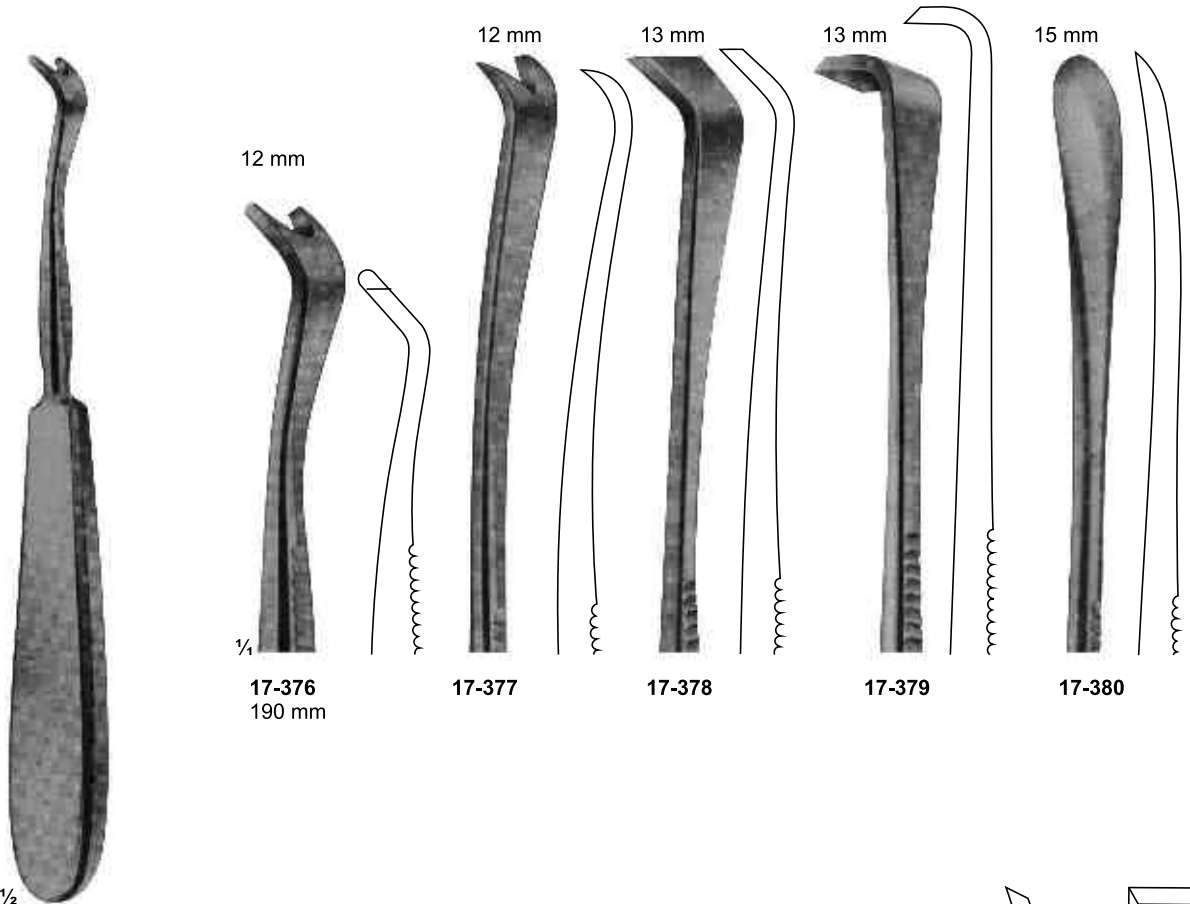

12 mm  
12 mm  
12 mm  
13 mm  
13 mm  
13 mm  
15 mm

17-376  
190 mm

17-377

17-378

17-379

17-380

1/2  
17-376 - 380  
SEMB  
230 mm

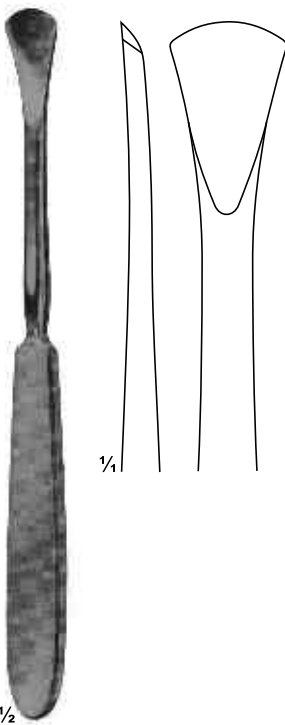

1/2  
17-381  
LANGENBECK  
190 mm

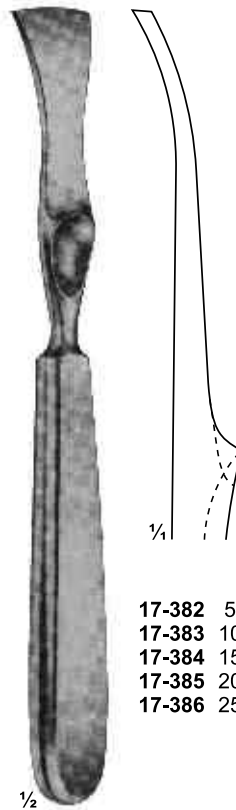

17-382 5 mm  
17-383 10 mm  
17-384 15 mm  
17-385 20 mm  
17-386 25 mm

1/2  
17-382 - 386  
LAMBOTTE  
215 mm

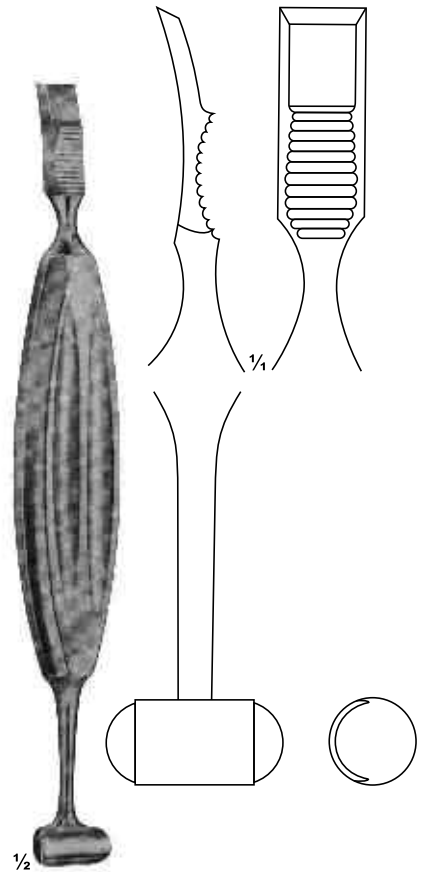

1/2  
17-387  
ALEXANDER  
210 mm

# Rib Spreaders

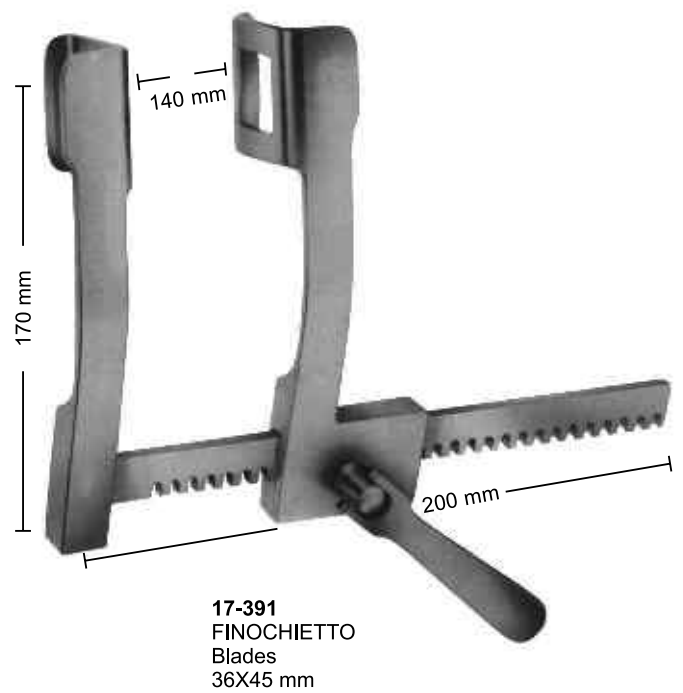
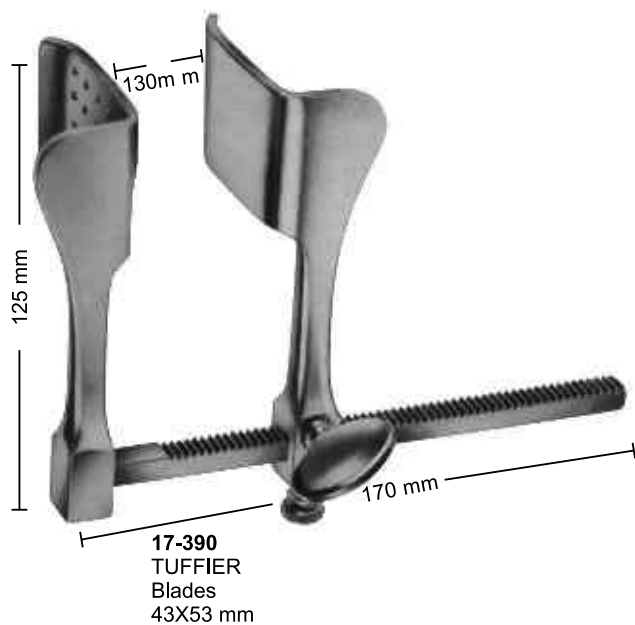
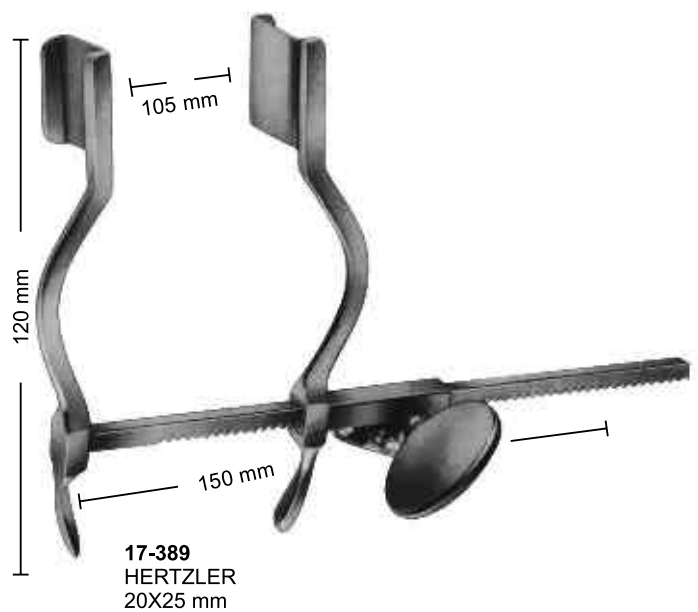
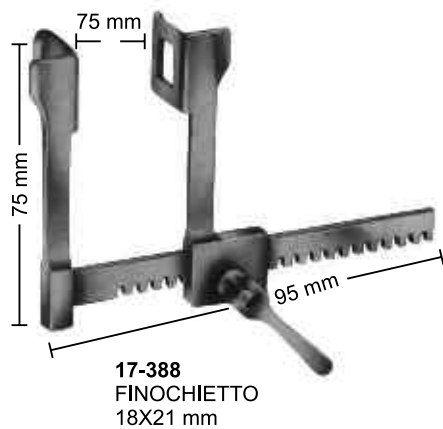

## Rib Spreaders

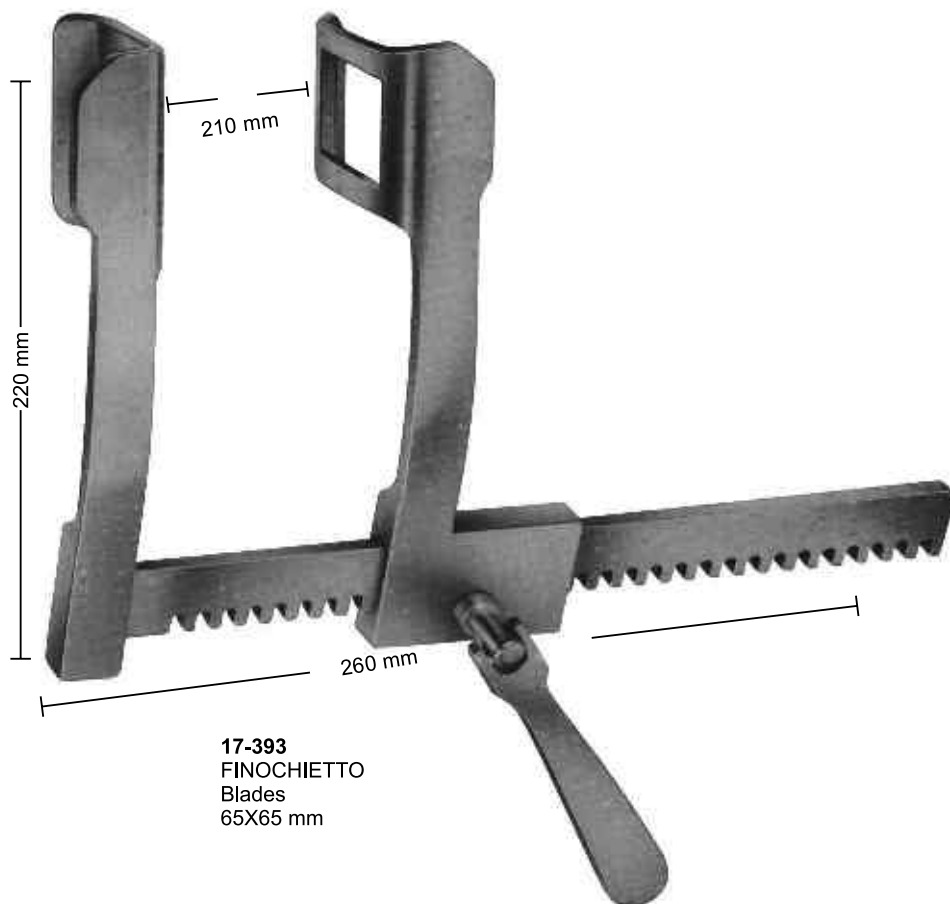
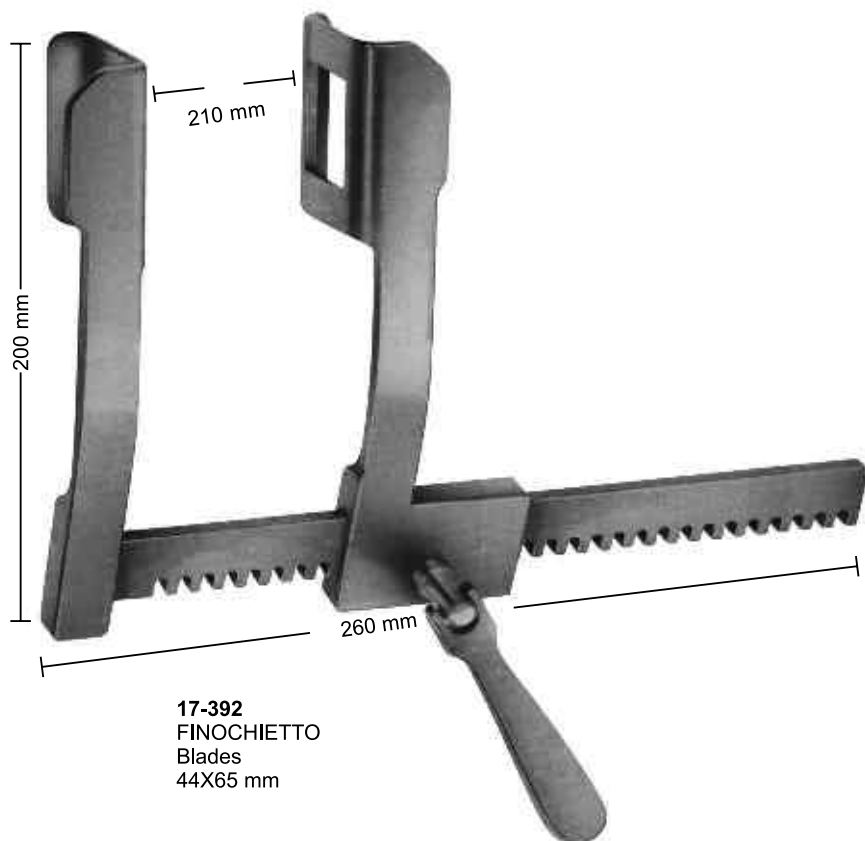

# Rib Spreaders



**17-395**  
Blades  
46x67 mm



**17-396**  
Blades  
80x67 mm



**17-397**  
Blades  
46x67 mm



**17-398**  
Blade, Only, for preparation  
of a. Mammaria, 25.5x80mm

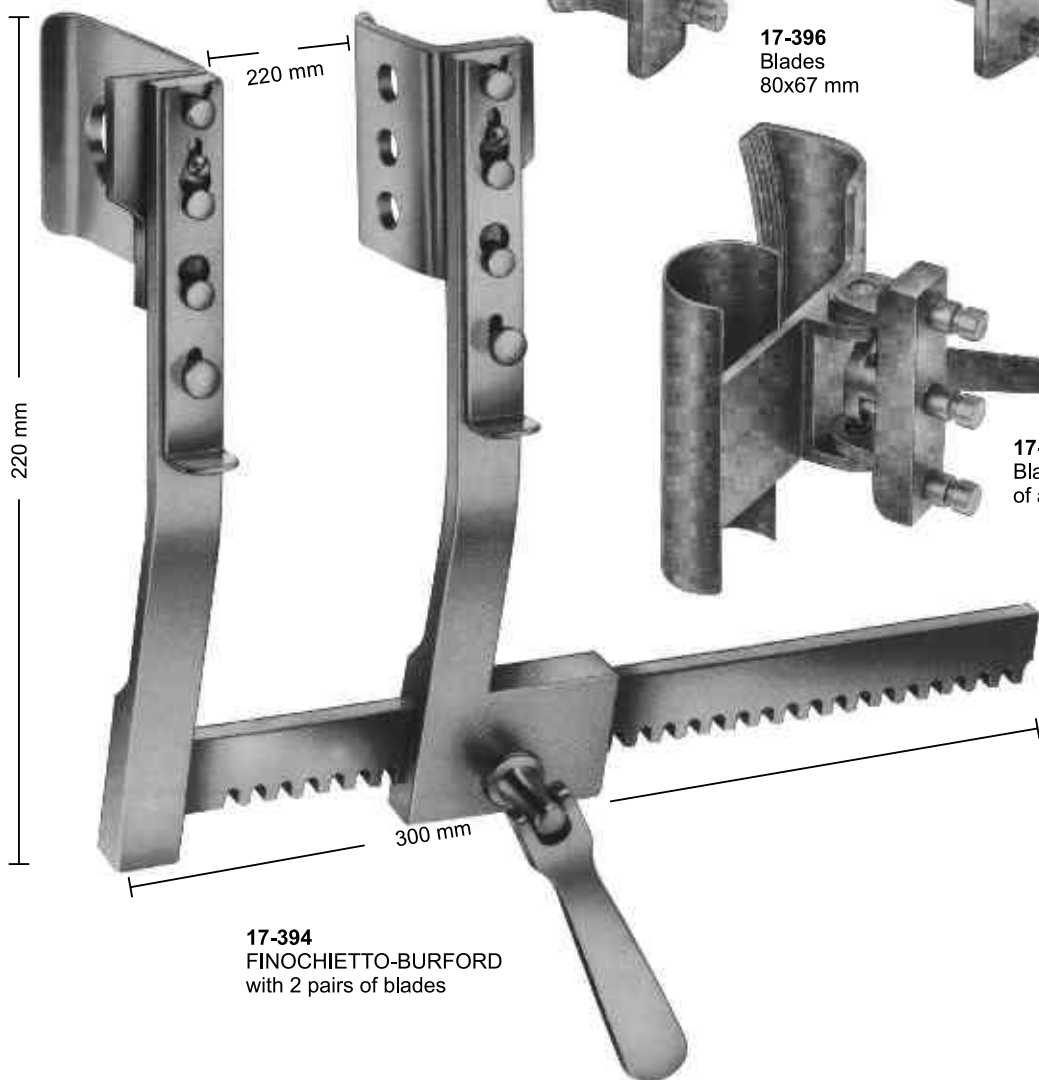

**17-394**  
FINOCHIETTO-BURFORD  
with 2 pairs of blades

# Rib Spreaders

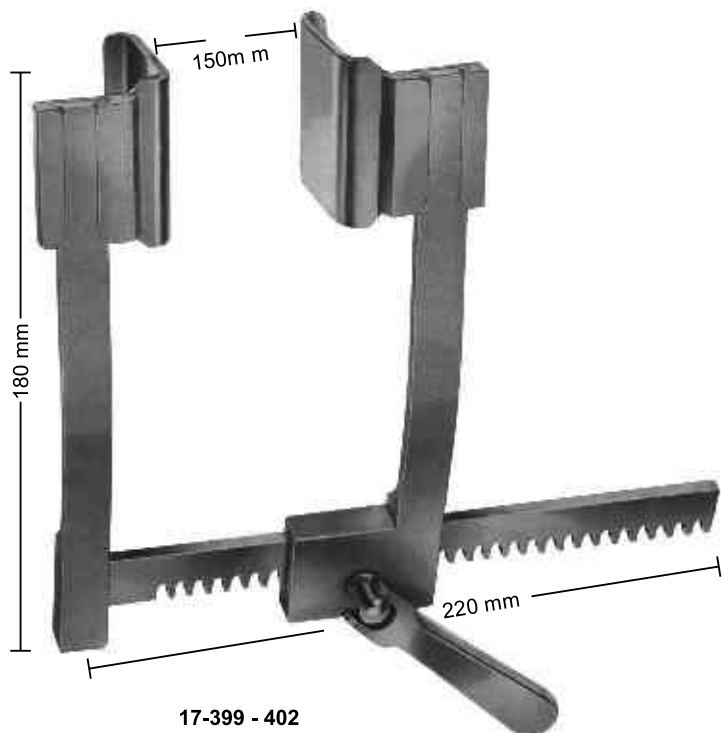

**17-399 - 402**  
DE-BAKEY  
with 3 pairs of blades

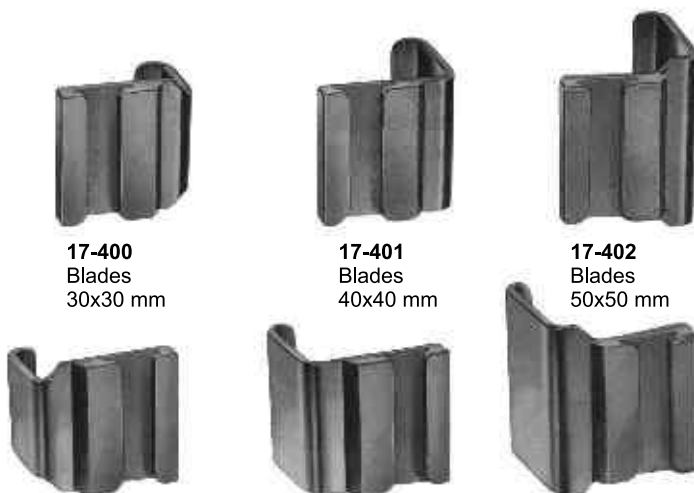

**17-400**  
Blades  
30x30 mm

**17-401**  
Blades  
40x40 mm

**17-402**  
Blades  
50x50 mm

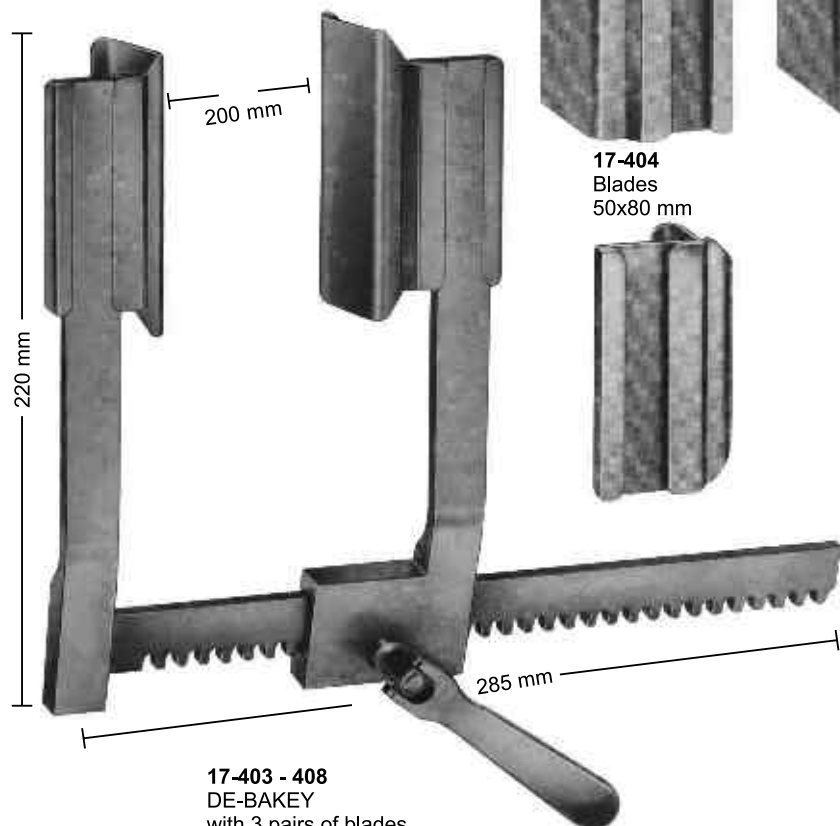

**17-403 - 408**  
DE-BAKEY  
with 3 pairs of blades

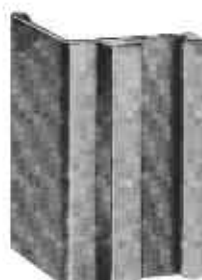

**17-404**  
Blades  
50x80 mm

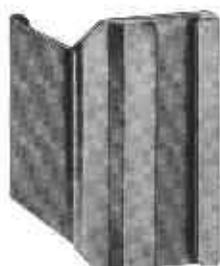

**17-405**  
Blades  
80x60 mm

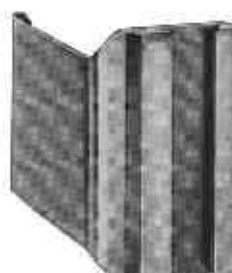

**17-406**  
Blades  
50x80 mm

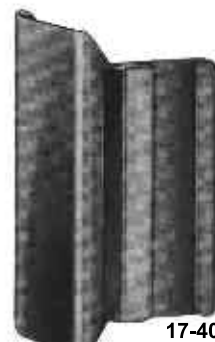

**17-407**  
Blades  
40x100 mm

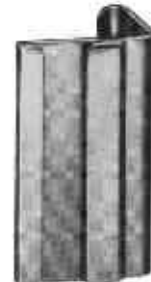
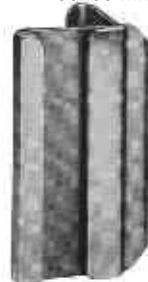
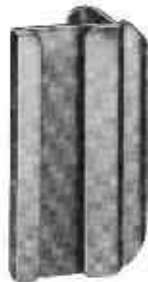

**17-408**  
Sternotomy Blades  
50x660 mm

# Sternotomy Spreaders

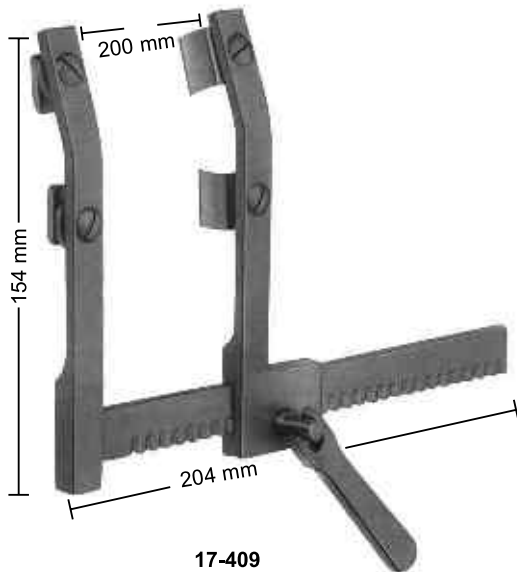

**17-409**  
MORSE  
Sternotomy spreader  
for children, with moveable  
double, each blade  
12x20 mm

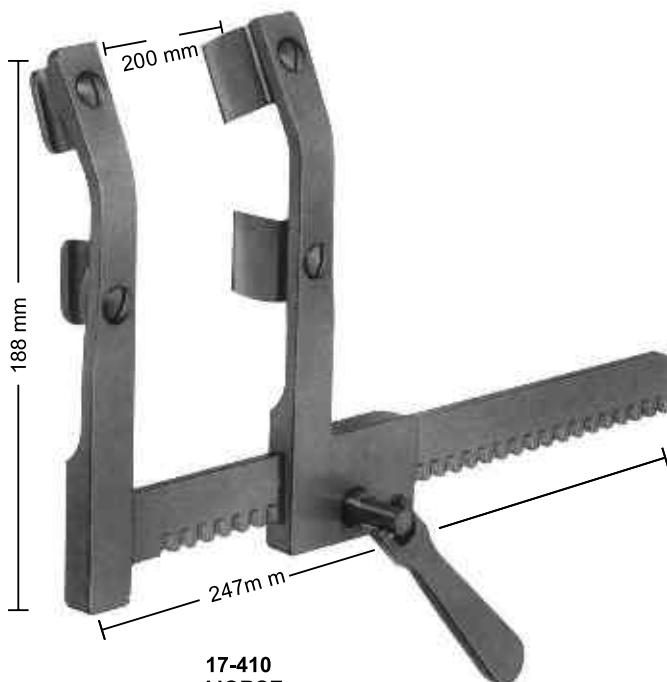

**17-410**  
MORSE  
Sternotomy spreader  
for adults, with moveable  
double, each blade  
19x19 mm



# Sternotomy- Spreaders

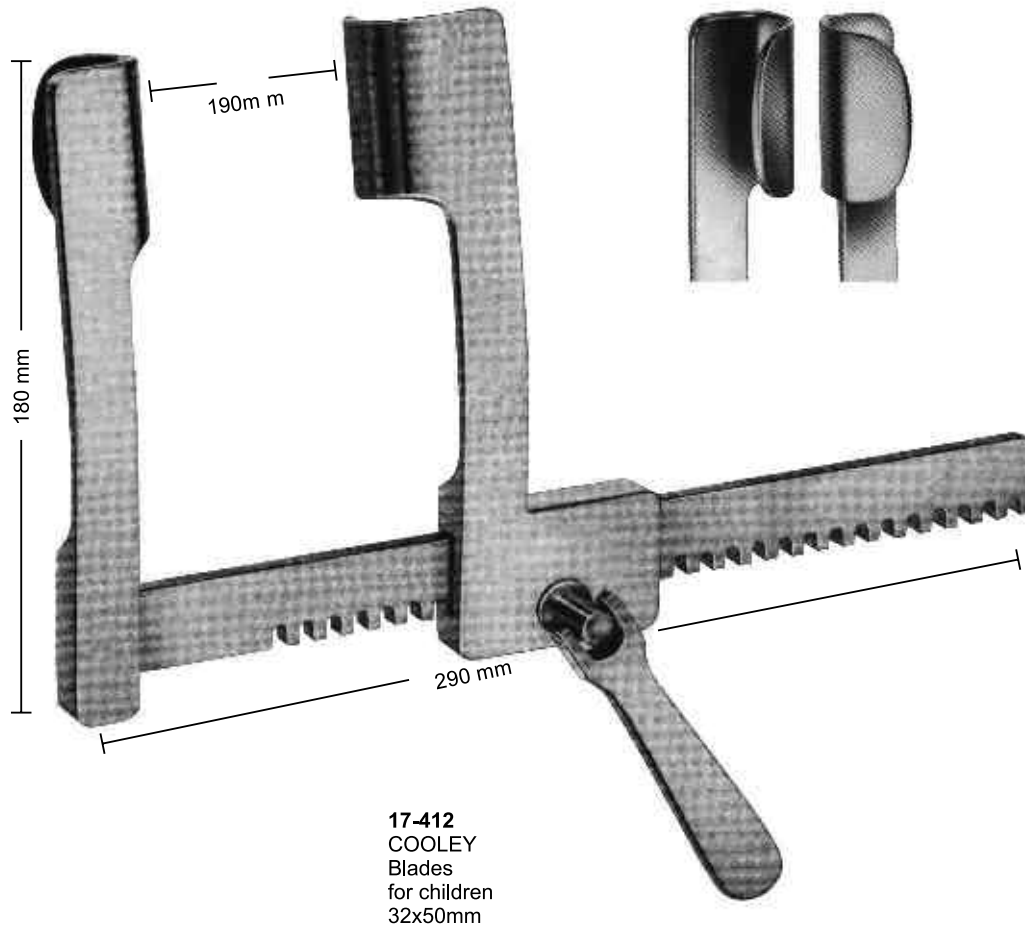
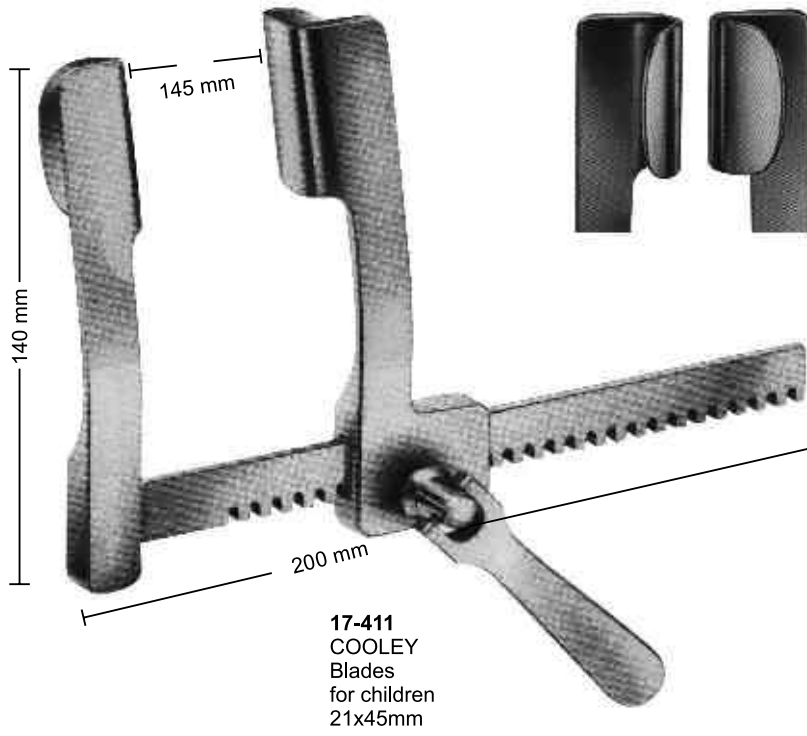

# Thoracic Retractors



**17-414**  
Blades  
75x75 mm



**17-415**  
Blades  
42x65 mm

Blades with Ball Snap System  
Delivery: in Pairs

- 17-413 - 415**  
Thoraxsperrer (Mercedes-Sperrer)  
complete consisting of:  
**17-413** Retractor only  
**17-414** 1 Pair of blades 42x65 mm  
**17-415** 1 Pair of blades 75x75 mm

# Rib Spreaders-and Contractors



1/2

**17-416**  
SELLORS  
Rib spreader-and contractor  
with swivel blades  
200 mm



1/2

**17-417**  
BAILEY  
150 mm

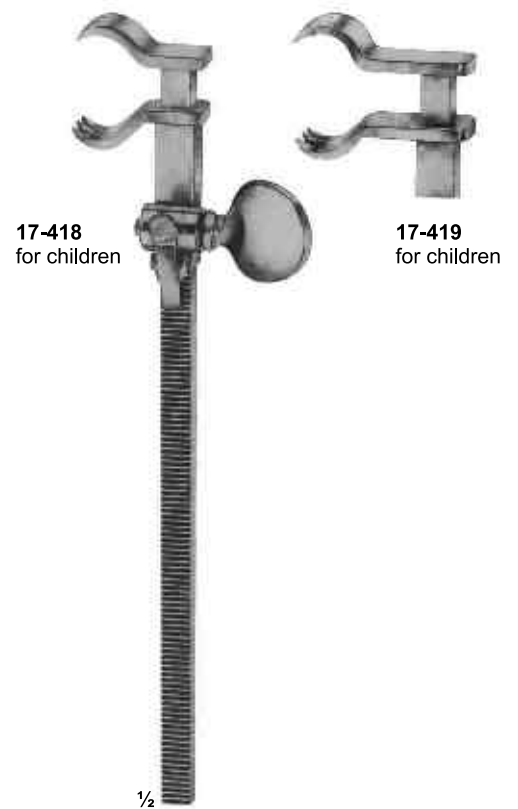

**17-418**  
for children

**17-419**  
for children

1/2

**17-418 - 419**  
BAILEY  
200 mm

# Rib Spreaders-and Contractors

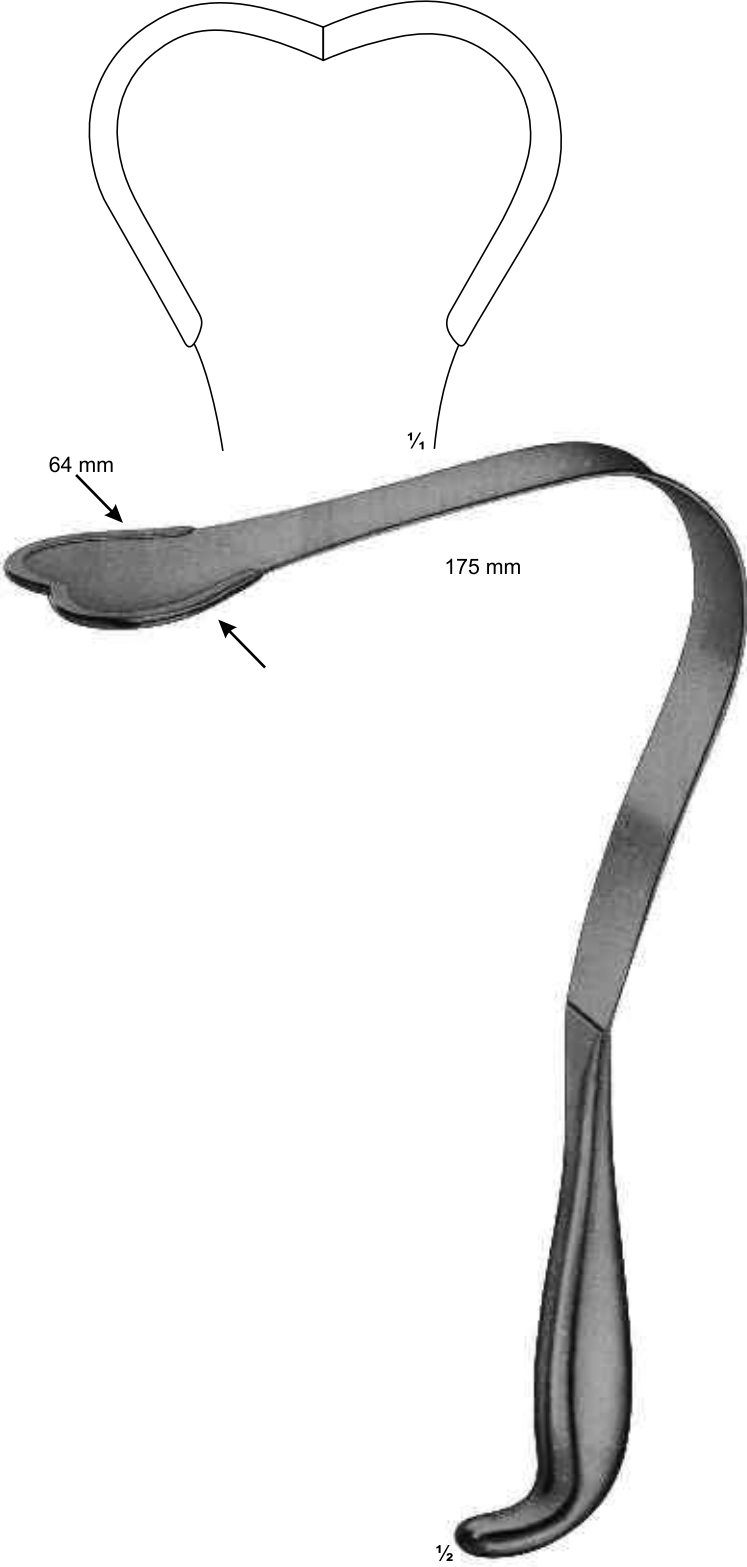

**17-420**  
**HARRINGTON-PEMBERTON**  
 federnd/flexible  
 295 mm

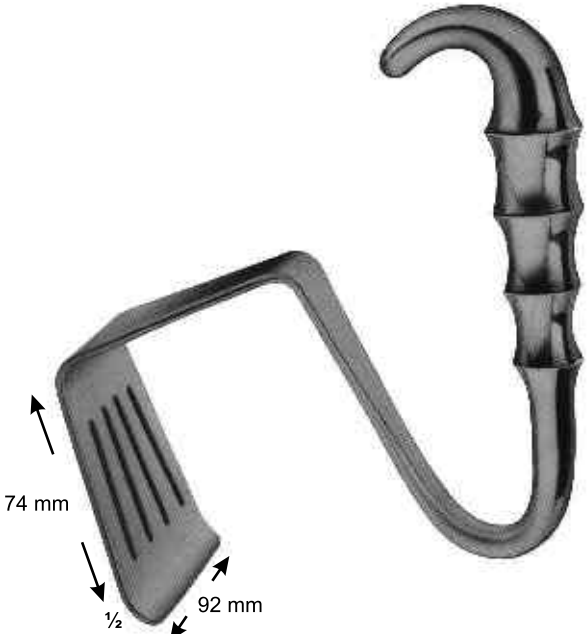

**17-421**  
**DAVIDSON**  
 Scalpel haken

# Rib Spreaders-and Contractors



**17-422**  
ALLISON  
255 mm



**17-423**  
ALLISON  
320 mm



**17-424**  
DE BAKEY  
With central bore,  
3.0mm diam,  
with lateral slots  
275 mm



**17-425**  
YANKAUER  
With central bore,  
2.0mm diam.  
285 mm

# Punches

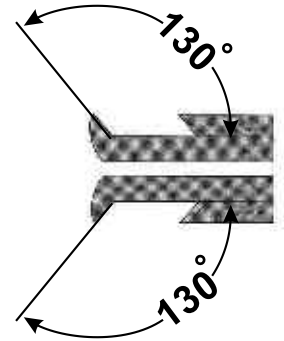
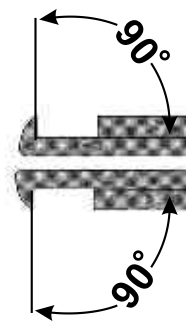
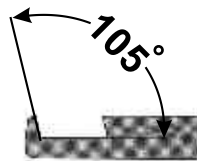

90° upwards cutting

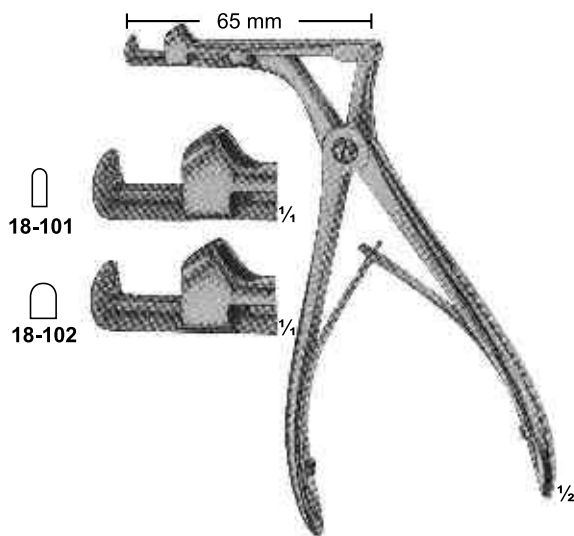

**18-101 - 102**  
CITELLI  
2 mm, 3,5 mm

90° upwards cutting

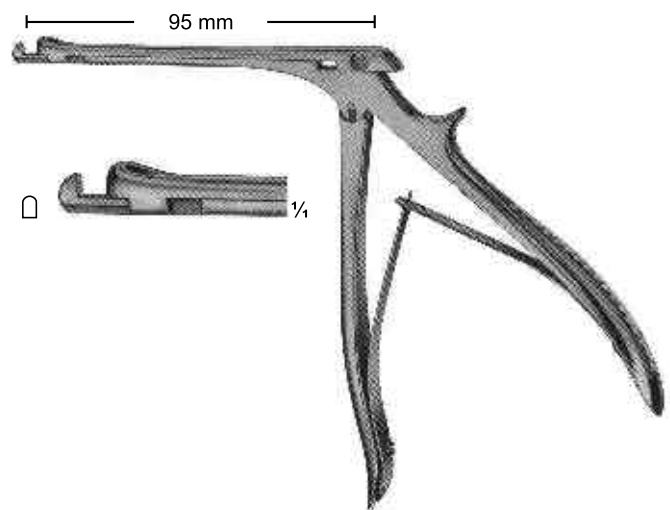

**18-103**  
CITELLI- BEYER  
1,8 mm

# Punches

**90°** upwards cutting

85 mm

**18-104**  
4 mm



**18-105**  
5 mm

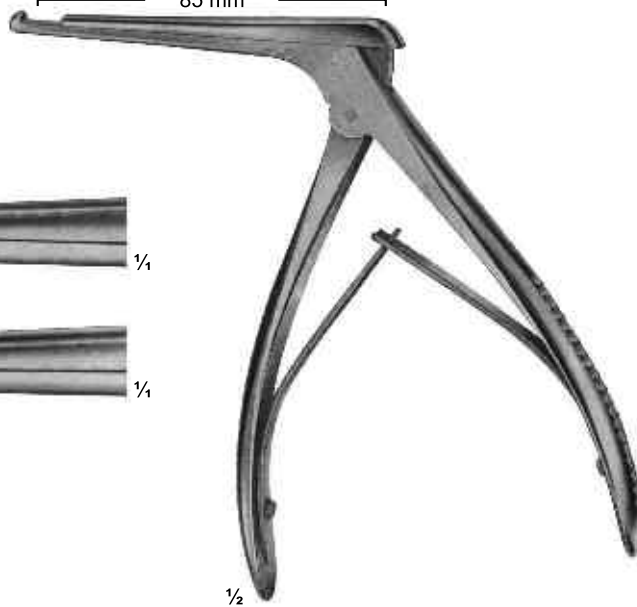

**18-104 - 105**  
KERRISON

**90°** upwards cutting

140 mm

**18-106**  
3,3 mm



**18-107**  
4,0 mm

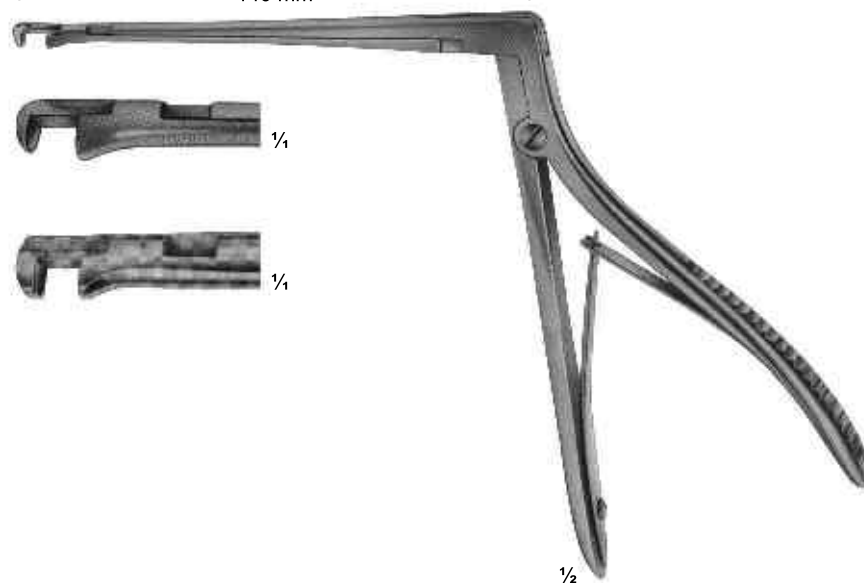



**18-106 - 107**  
HAJEK-KOFLER

# Punches

**130°** upwards cutting

**18-108**  
1 mm 

**18-109**  
2 mm 

**18-110**  
3 mm 

**18-111**  
4 mm 

**18-112**  
5 mm 

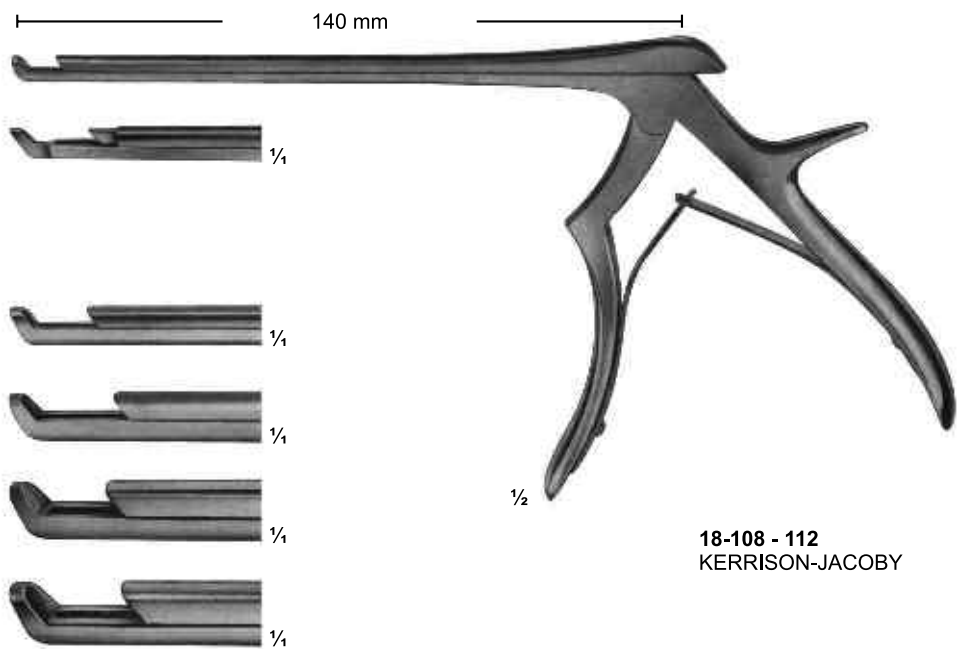

**18-108 - 112**  
KERRISON-JACOBY

**90°** upwards cutting

**18-113**  
1 mm 

**18-114**  
2 mm 

FERRIS-SMITH-KERRISON

**18-115**  
3 mm 

**18-116**  
4 mm 

**18-117**  
5 mm 

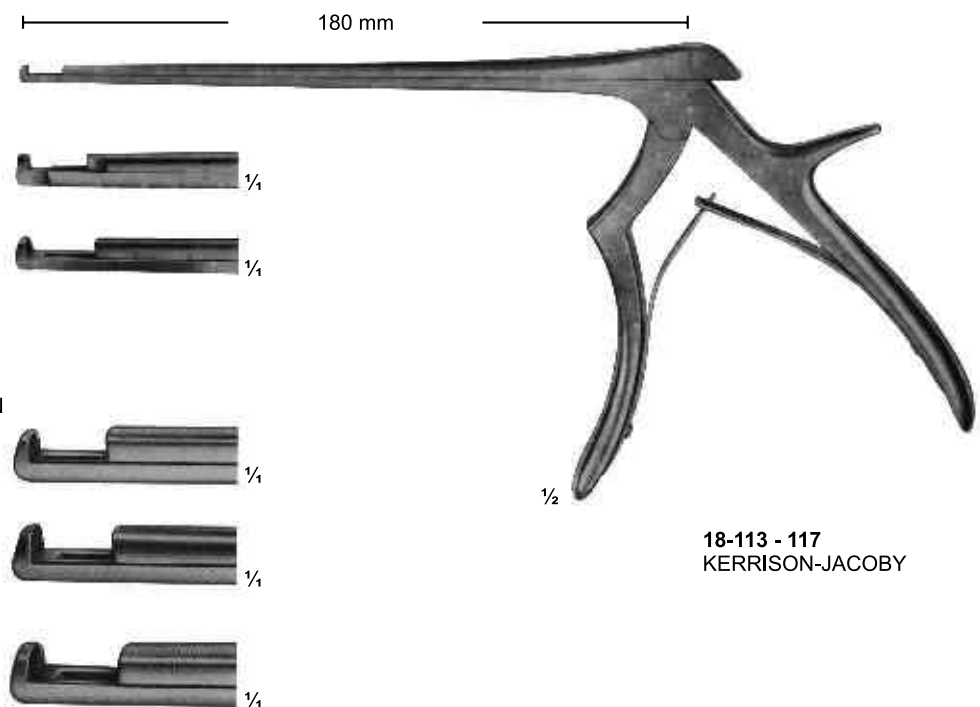

**18-113 - 117**  
KERRISON-JACOBY



# Rongeurs

Angled positions for rongeurs

**18-118**  
3,0 mm

**18-119**  
3,6 mm

**18-120**  
4,2 mm

**18-121**  
4,8 mm

**18-122**  
5,8 mm

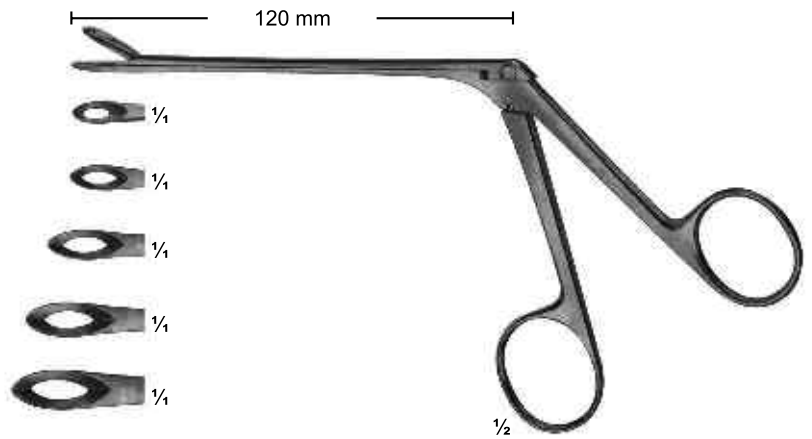

**18-118 - 122**  
WEIL-BLAKESLEY

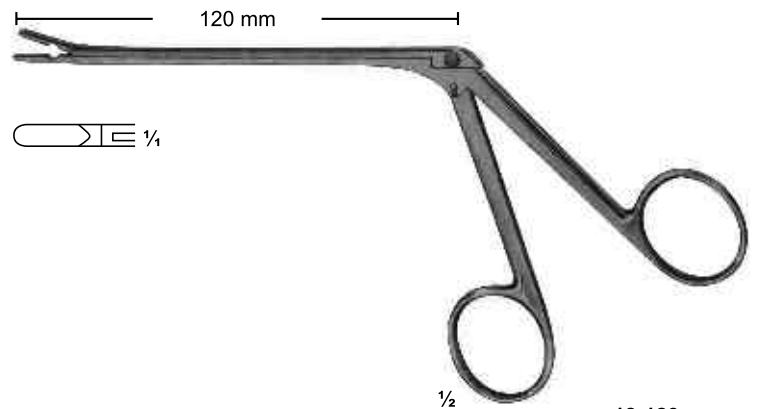

**18-123**  
TAKAHASHI  
3 mm

**130°**

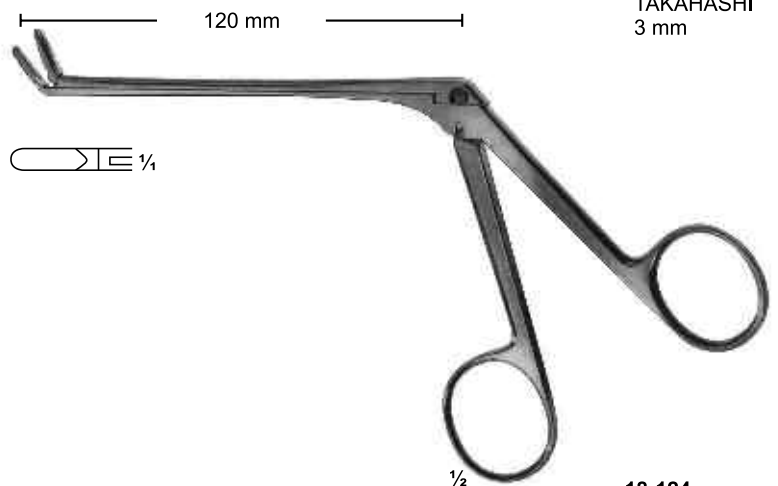

**18-124**  
TAKAHASHI  
3 mm

# Rongeurs

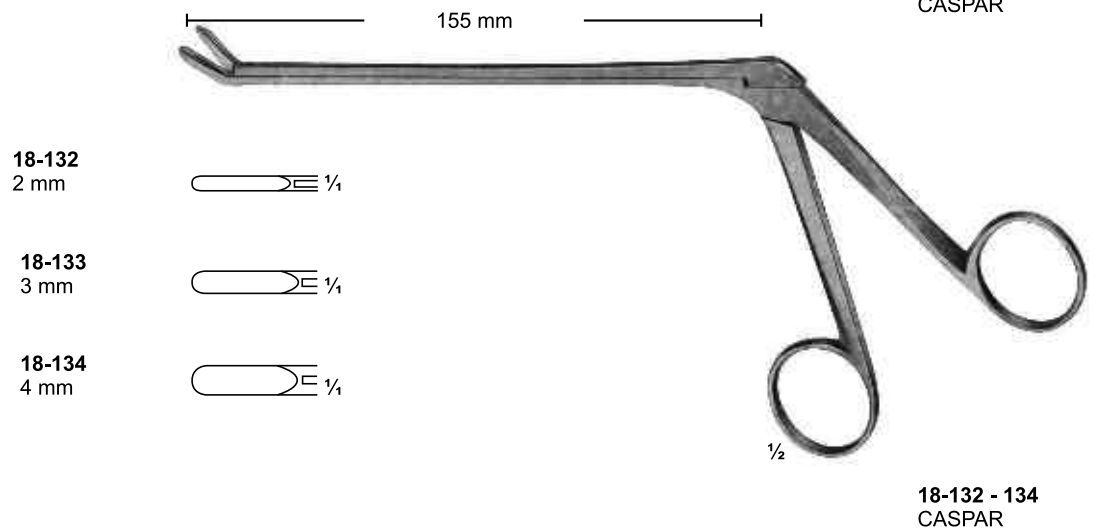
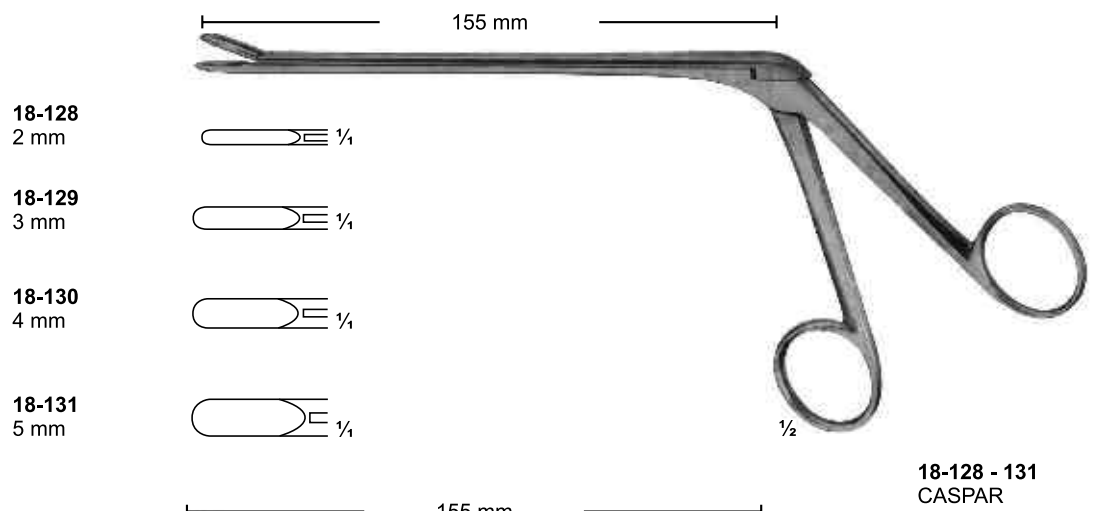
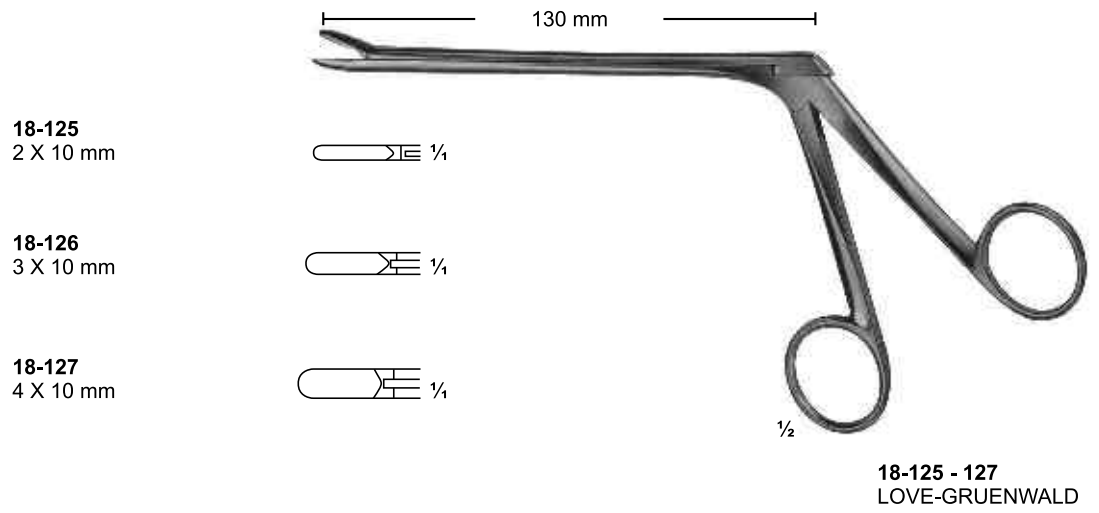

# Rongeurs

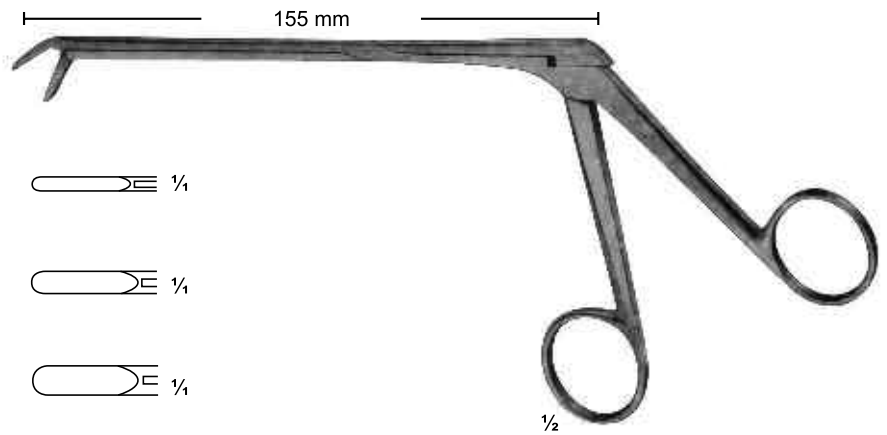

**18-135**  
2 mm

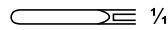

**18-136**  
3 mm

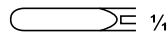

**18-137**  
4 mm

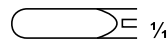

**18-135 - 137**  
CASPAR

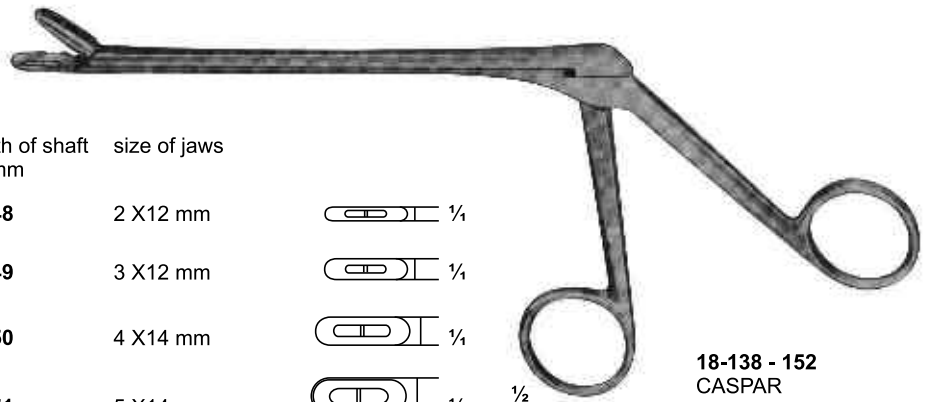

Length of shaft 140 mm	Length of shaft 160 mm	Length of shaft 185 mm	size of jaws
<b>18-138</b>	<b>18-143</b>	<b>18-148</b>	2 X12 mm
<b>18-139</b>	<b>18-144</b>	<b>18-149</b>	3 X12 mm
<b>18-140</b>	<b>18-145</b>	<b>18-150</b>	4 X14 mm
<b>18-141</b>	<b>18-146</b>	<b>18-151</b>	5 X14 mm
<b>18-142</b>	<b>18-147</b>	<b>18-152</b>	6 X16 mm



**18-138 - 152**  
CASPAR

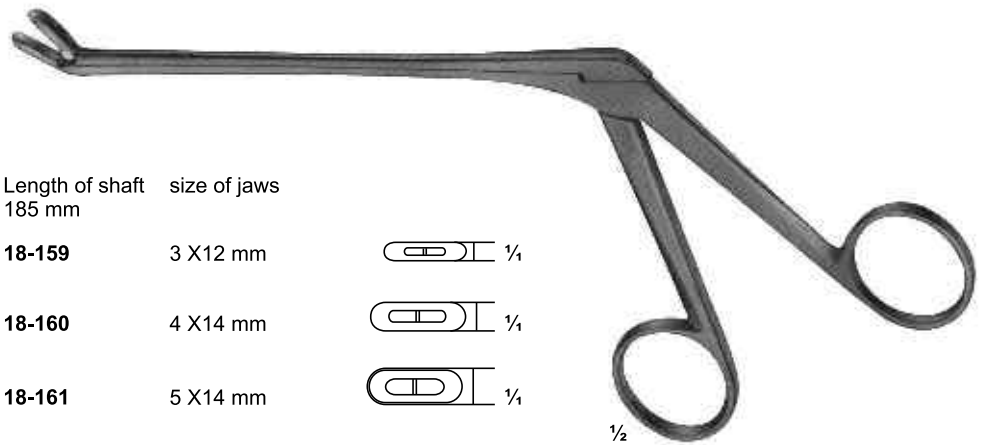

Length of shaft 140 mm	Length of shaft 160 mm	Length of shaft 185 mm	size of jaws
<b>18-153</b>	<b>18-156</b>	<b>18-159</b>	3 X12 mm
<b>18-154</b>	<b>18-157</b>	<b>18-160</b>	4 X14 mm
<b>18-155</b>	<b>18-158</b>	<b>18-161</b>	5 X14 mm



**18-153 - 161**  
CASPAR

# Rongeurs

Length of shaft 140 mm	Length of shaft 160 mm	Length of shaft 185 mm	size of jaws
<b>18-162</b>	<b>18-164</b>	<b>185-166</b>	3 X12 mm
<b>18-163</b>	<b>18-165</b>	<b>18-167</b>	4 X14 mm

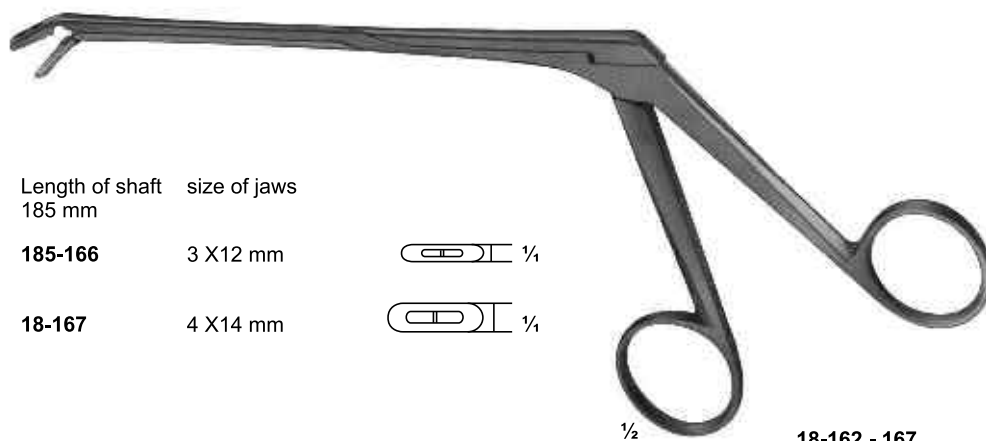

**18-162 - 167**  
GUSHING

**18-168**  
2 X 10 mm  
GUSHING

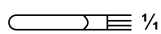

**18-169**  
3 X 10 mm  
LOVE-GRUENWALD

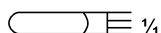

**18-170**  
4 X 10 mm  
SPURLING

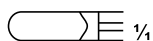

**18-168 - 170**  
LOVE-GRUENWALD

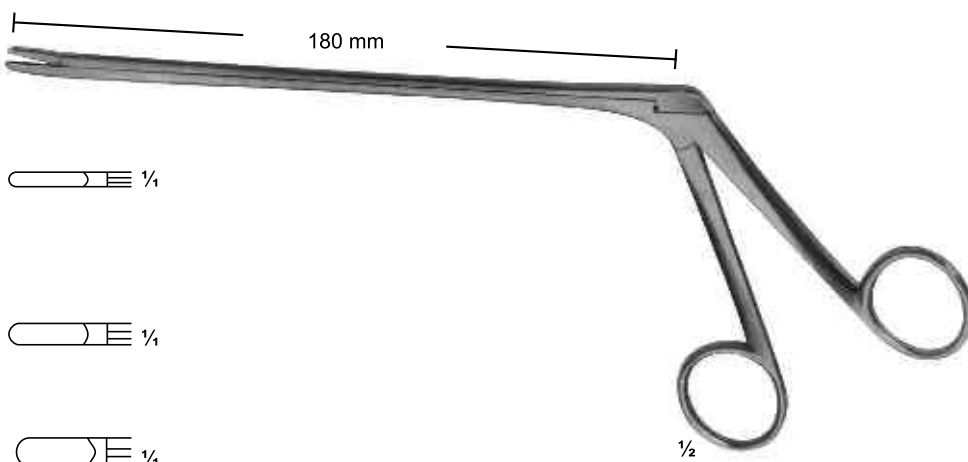
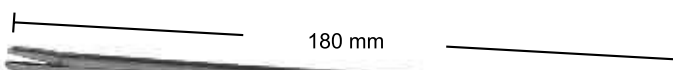

**18-171**  
3 X 10 mm  
LOVE-GRUENWALD



**18-172**  
4 X 10 mm  
SPURLING

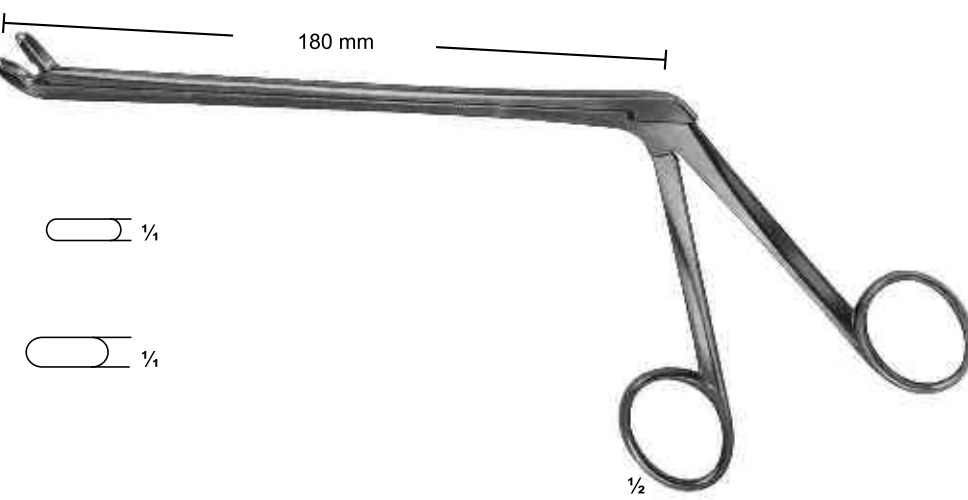
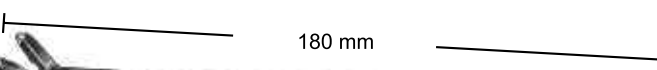

**18-171 - 172**  
LOVE-GRUENWALD

# Rongeurs

**18-173**  
3 X 10 mm  
LOVE-GRUENWALD

**18-174**  
4 X 10 mm  
SPURLING

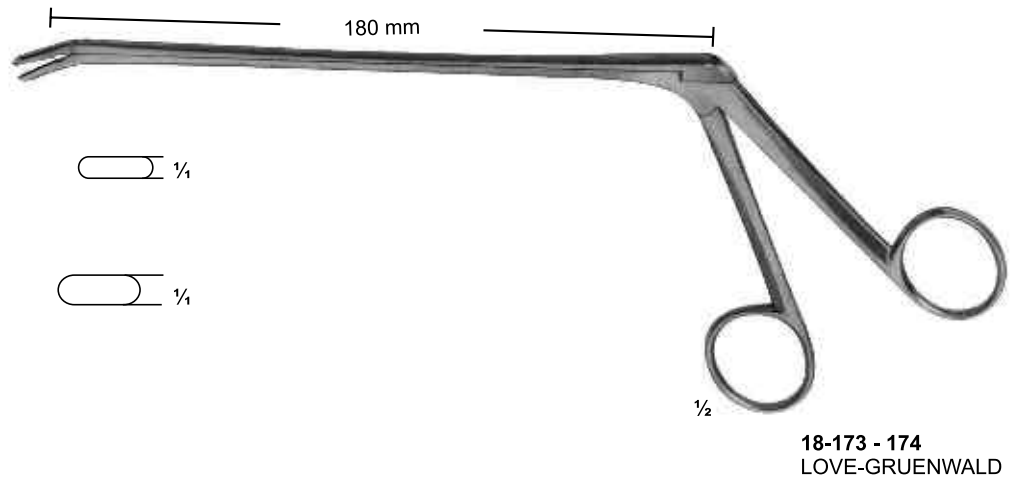

**18-175**  
7 mm

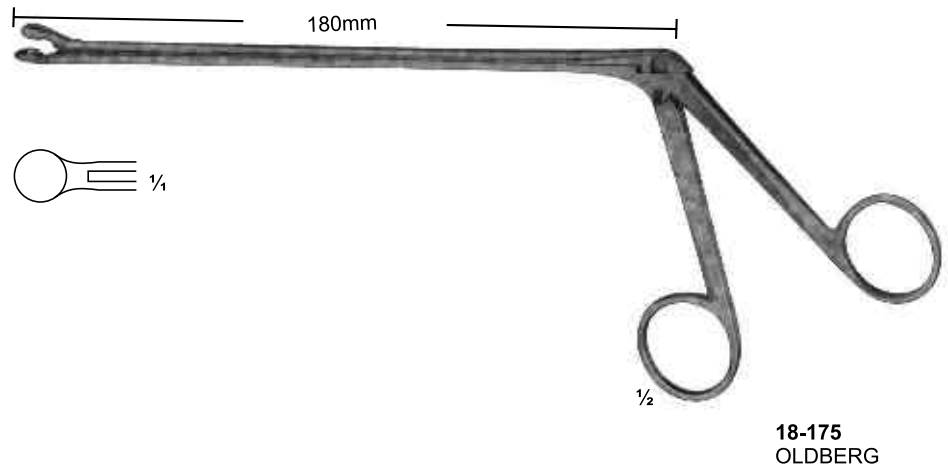

**18-176**  
YASARGIL  
2,2 mm

**18-177**  
YASARGIL  
3,5 mm

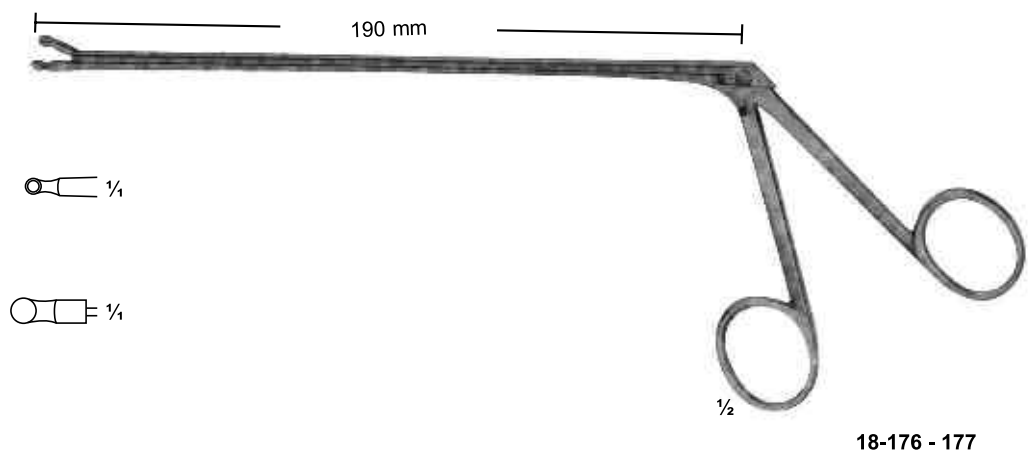

# Rongeurs

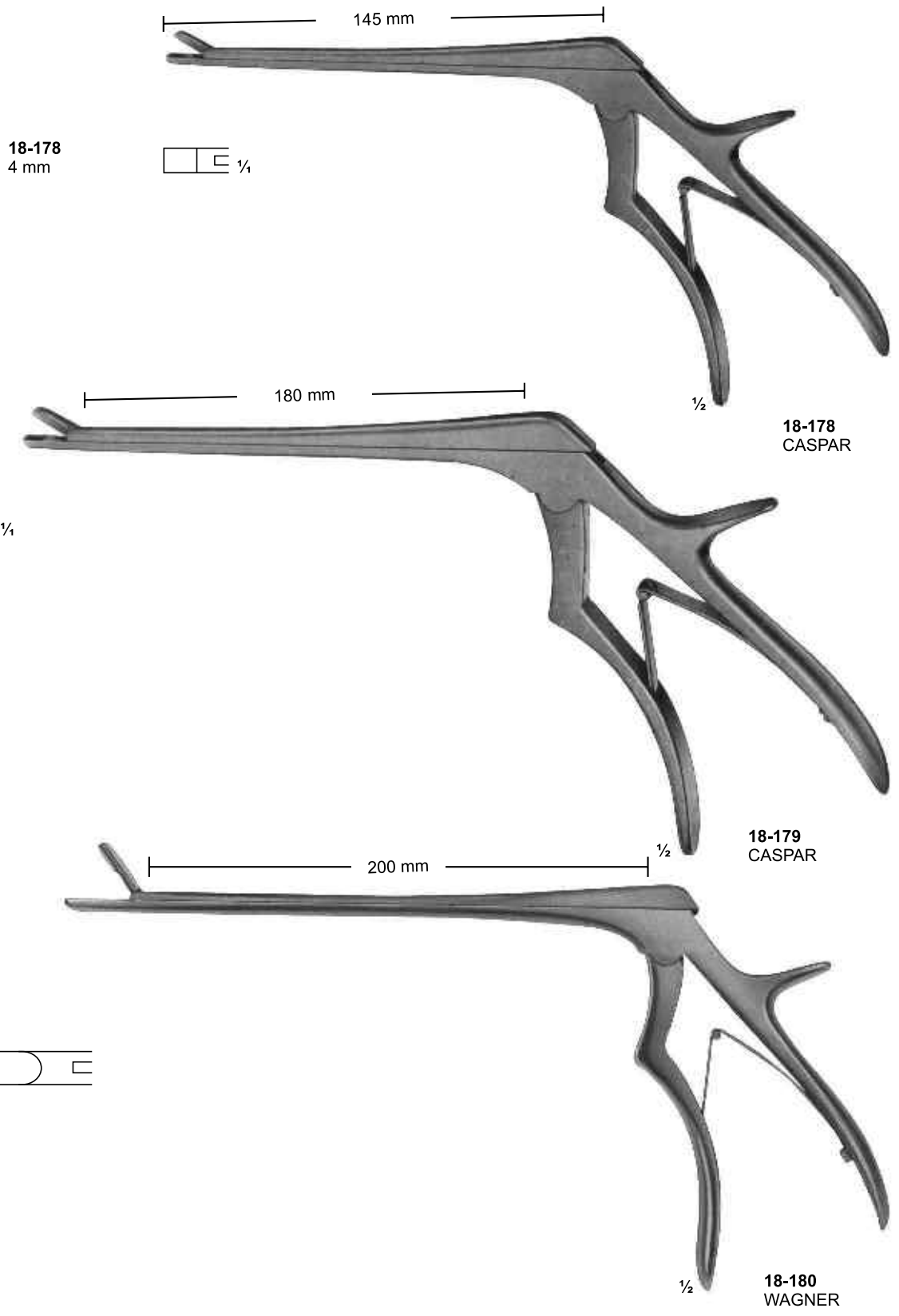

# Amputation



**19-101**  
Comprimeter. Compression apparatus for producing exsanguination in the extremities. Manometer registers up to 600 mm Hg. Complete, consisting of :  
**19-101** 2 Pump with manometer  
**19-102** 3 Cuff for the leg  
**19-103** 14 Cuff for the upper arm



**19-104** 3 Cuff for the leg  
**19-105** 4 Cuff for the lower arm  
**19-106** 5 Cuff for children  
**19-107** 14 Cuff for the upper arm



**19-108**  
ESMARCH  
Staubinde  
Compression bandage  
5 m lang/long  
6 cm breit/wide



**19-109**  
ESMARCH  
Stauschlauch  
Compression tube  
1 m lang/long

# Amputation and Resection Knives



$\frac{1}{2}$   
**19-110**  
 Length of blades  
 Phalangeal knife  
 105 mm



$\frac{1}{2}$   
**19-111**  
 Length of blades  
 Interosseous knife  
 110 mm



$\frac{1}{2}$   
**19-112**  
 Length of blades  
 Periosteum knife  
 with raspatory  
 65 mm



$\frac{1}{2}$   
**19-113 - 114**  
 LANGENBECK  
 Length of blades  
 Resection knives  
 55 mm



**19-113**

**19-114**



# Amputation Retractors

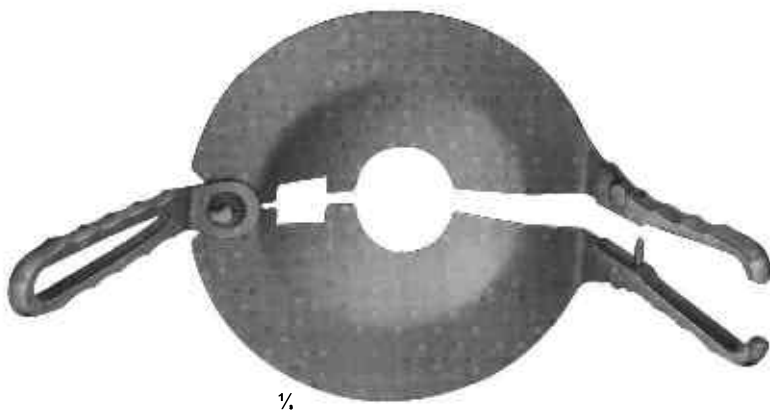

1/4

**19-115**  
PERCY  
removeable handles

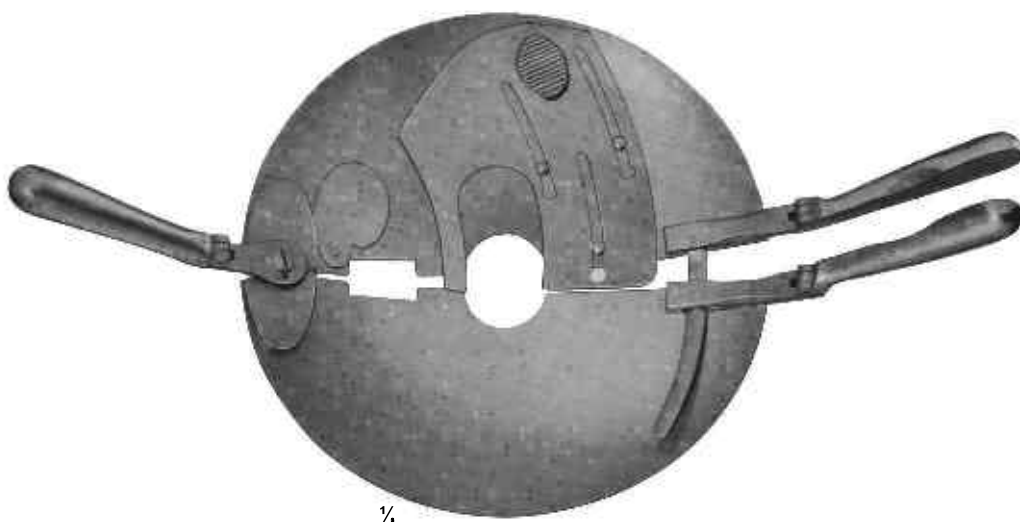

1/4

**19-116**  
PERCY  
reversible handles

# Amputation Saws



$\frac{1}{4}$   
**19-117**  
 CHARRIEER  
 Length of blade  
 215 mm  
 complete with one saw  
 blade each  
 350 mm  
 Spare saw blades, carbon steel  
**19-118** 12 mm  
**19-119** 20 mm

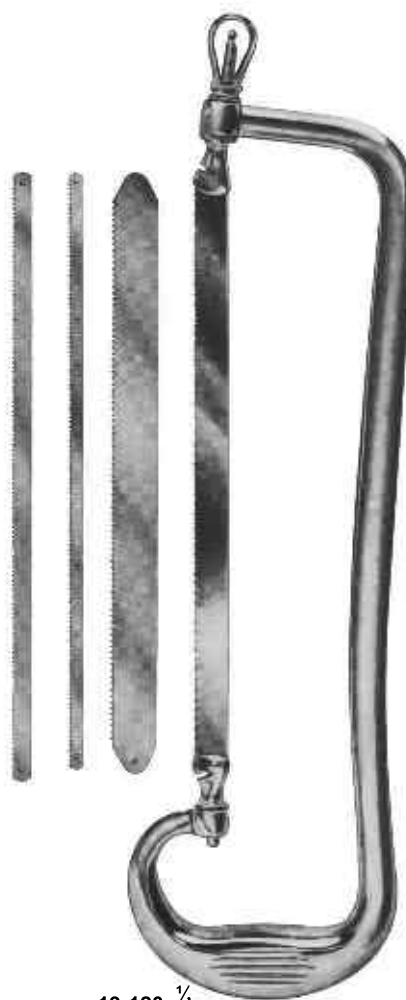

$\frac{1}{4}$   
**19-120**  
 RUST  
 Length of blade  
 235 mm  
 complete with one saw  
 blade each  
 390 mm  
**19-121** Bow only  
 Spare saw blades, carbon steel  
**19-122** 6 mm  
**19-123** 8 mm  
**19-124** 12 mm  
**19-125** 20 mm

# Amputation Saws

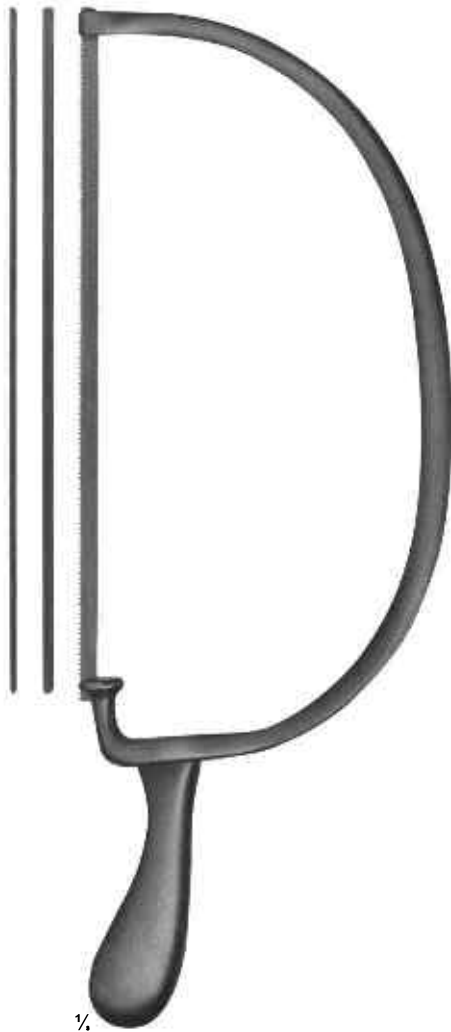

1/4

**19-126**  
**BIER**  
 Length of blade  
 270 mm  
 complete with one saw  
 blade each  
 420 mm  
 Spare saw blades, carbon steel  
**19-127** 4 mm  
**19-128** 6 mm  
**19-129** 8 mm



1/4

**19-130**  
**CHARRIERE**  
 Length of blade  
 180 mm  
 Spare saw blades,  
 carbon steel  
 270 mm

**19-131**  
**CHARRIERE**  
 Length of blade  
 240 mm  
 Spare saw blades,  
 carbon steel  
 340 mm



1/4

**19-132**  
**SATTERLEE**  
 Length of blade  
 200 mm  
 Spare saw blades,  
 carbon steel  
 290 mm



1/4

**19-133**  
**LANGENBACK**  
 Length of blade  
 115 mm  
 Metacarpal saw  
 235 mm

## Wire Saws and Conductor



**OLIVECRONA**  
**19-134** 300 mm  
**19-135** 400 mm  
**19-136** 500 mm  
**19-137** 700 mm



**GIGLI**  
**19-138** 300 mm  
**19-139** 400 mm  
**19-140** 500 mm  
fine, 6 wires twisted  
**19-141**  
coars, 4 wires twisted



$\frac{1}{4}$   
**19-142**  
**GIGLI**  
Handle



$\frac{1}{2}$   
**19-143**  
**LEBSCHE**  
Conductor for  
wire saws, malleable  
250 mm

# Elevators and Bone Levers

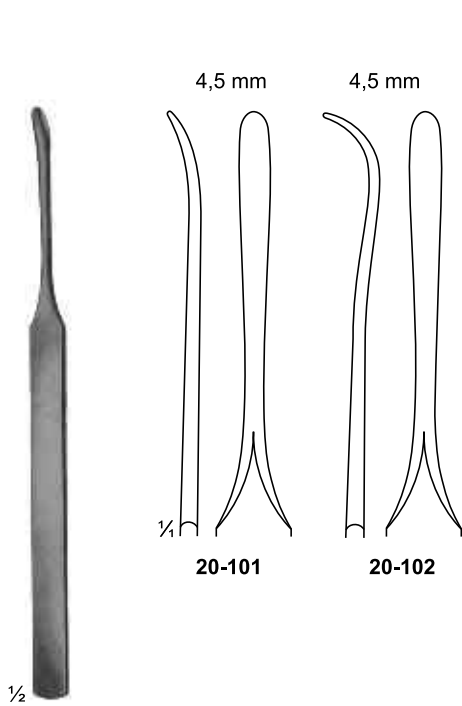

**20-101 - 102**  
KONIG  
155 mm

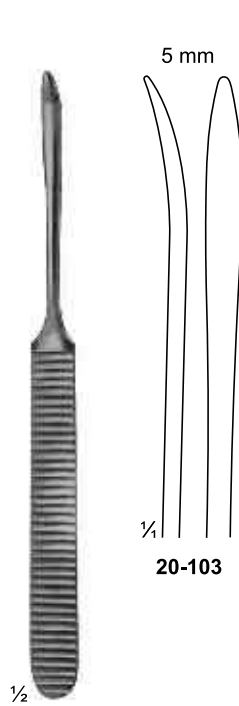

**20-103**  
WILLIGER  
165 mm

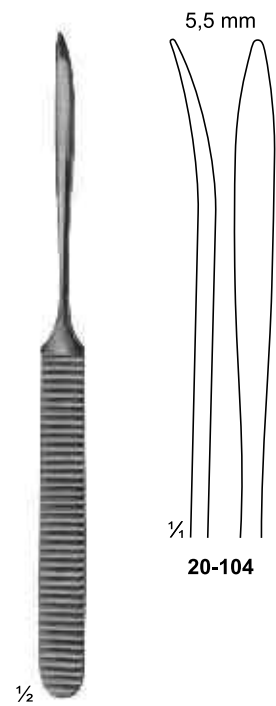

**20-104**  
WILLIGER  
170 mm

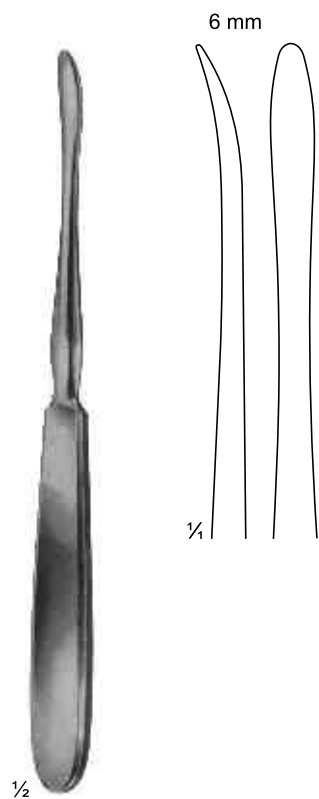

**20-105**  
QUERVAIN  
195 mm

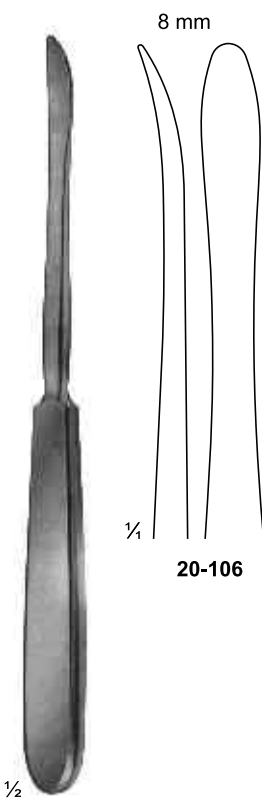

**20-106 - 107**  
LANGENBACK  
195 mm

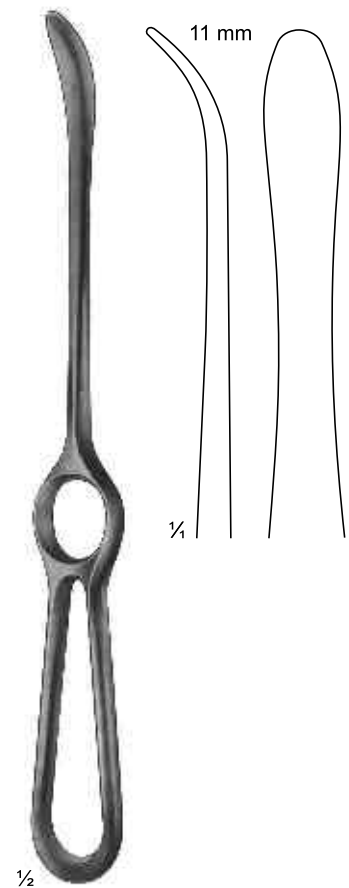

**20-108**  
LANGENBACK  
230mm

# Bone Levers

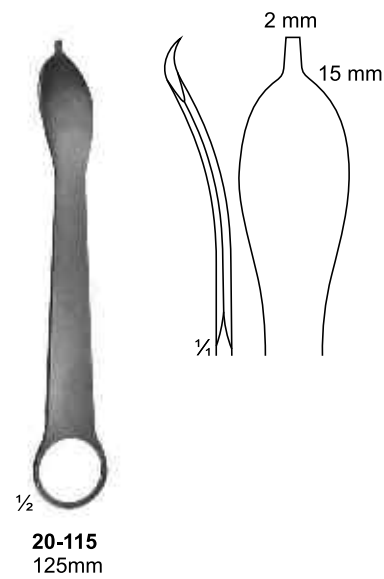
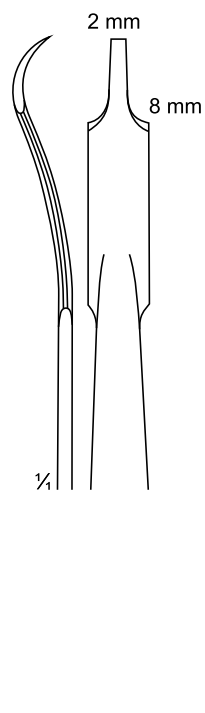
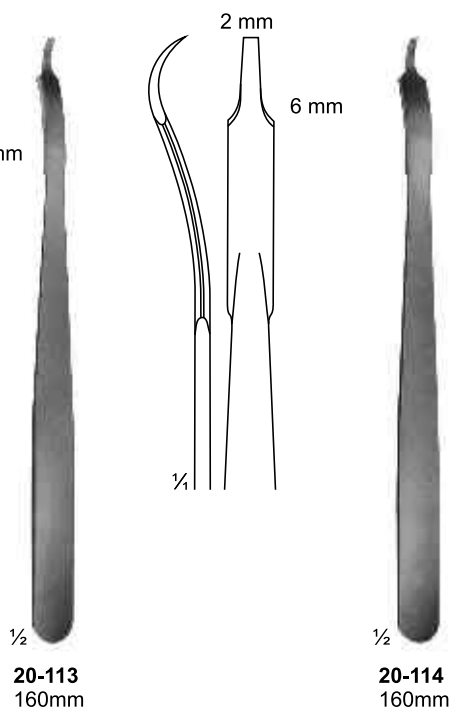
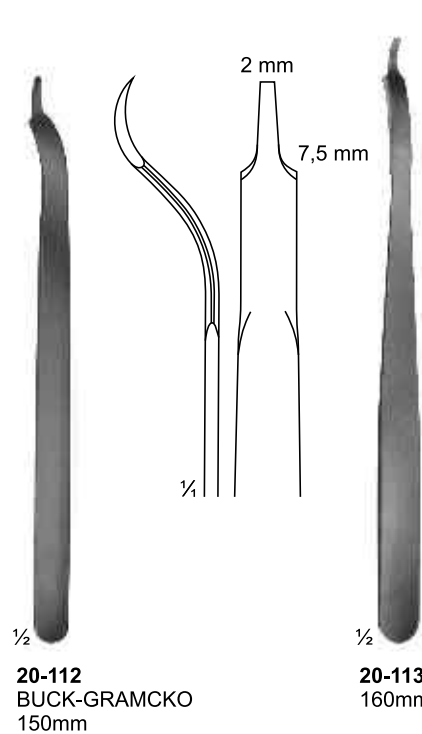
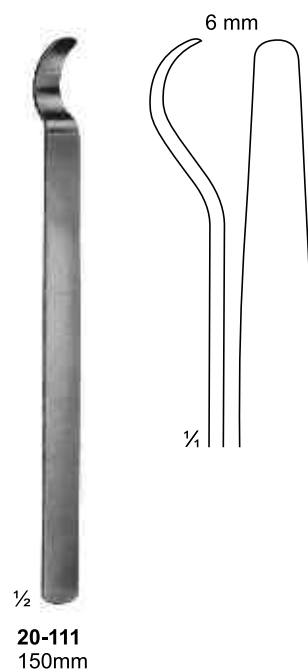
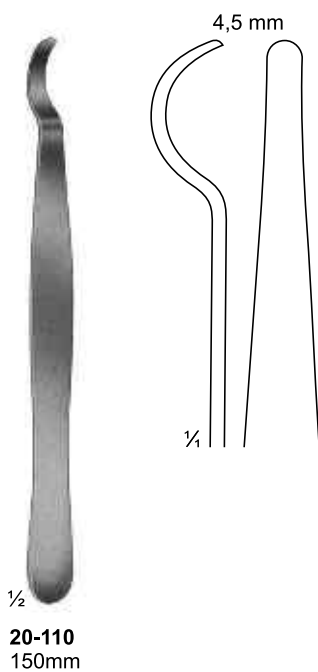
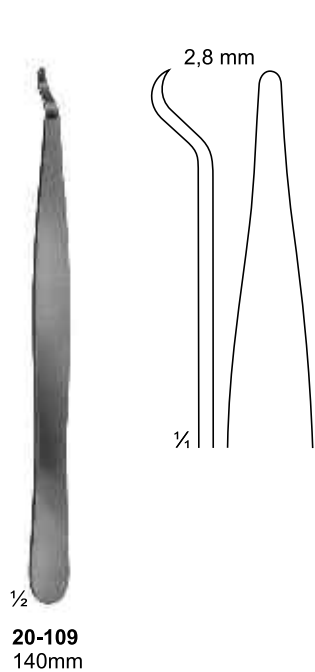

# Bone Levers



**20-116**  
LANE TRETOWAN  
215mm

**20-117**  
LANE  
255mm

**20-118**  
LANGE-HOHMANN  
250mm

**20-119 - 120**  
LANGE-HOHMANN  
**20-119** 265mm  
**20-120** 280mm

# Bone Levers

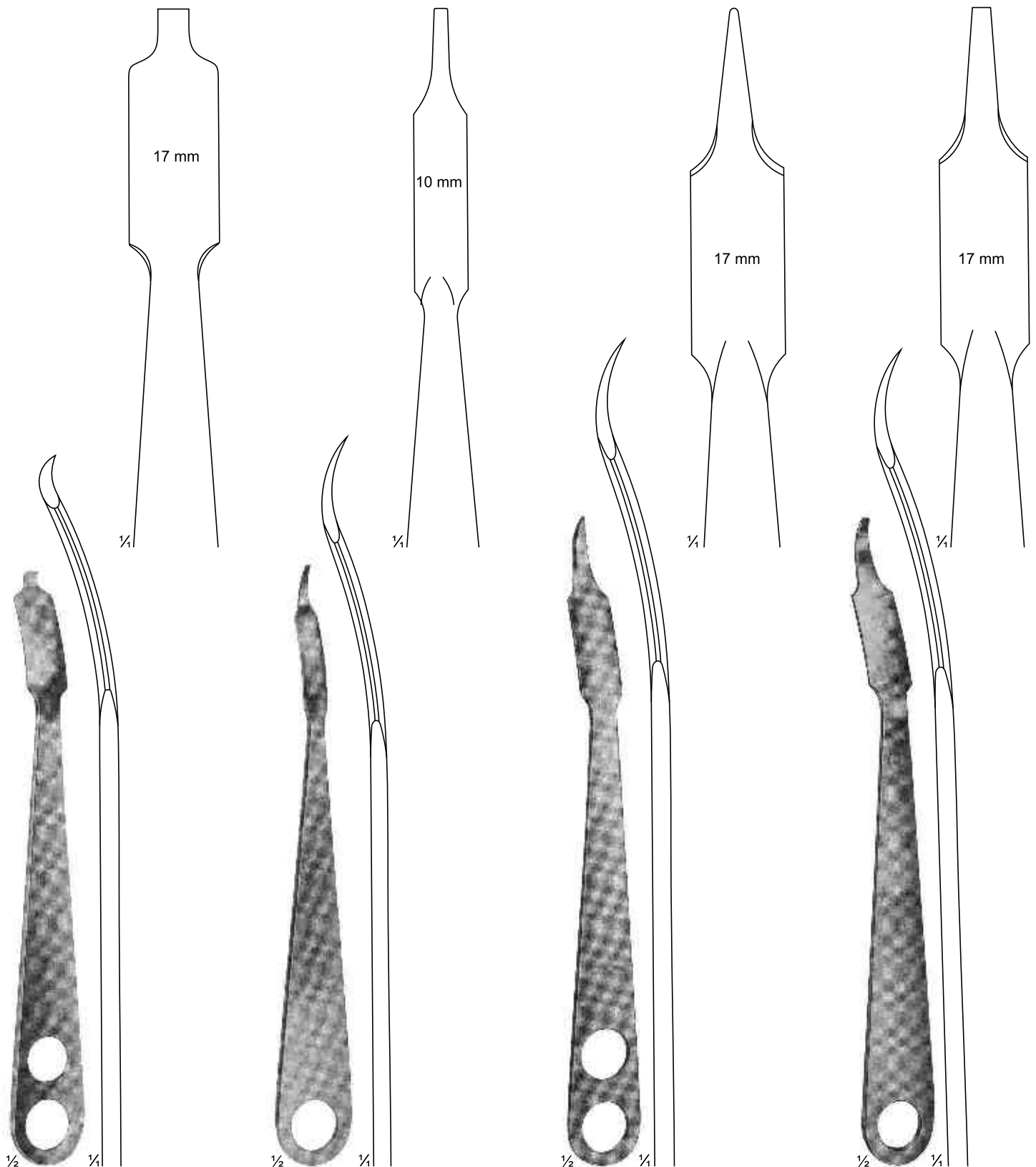

**20-121**  
WAGNER  
220 mm

**20-122**  
220 mm

**20-123**  
240 mm

**20-124**  
240 mm



# Bone Levers

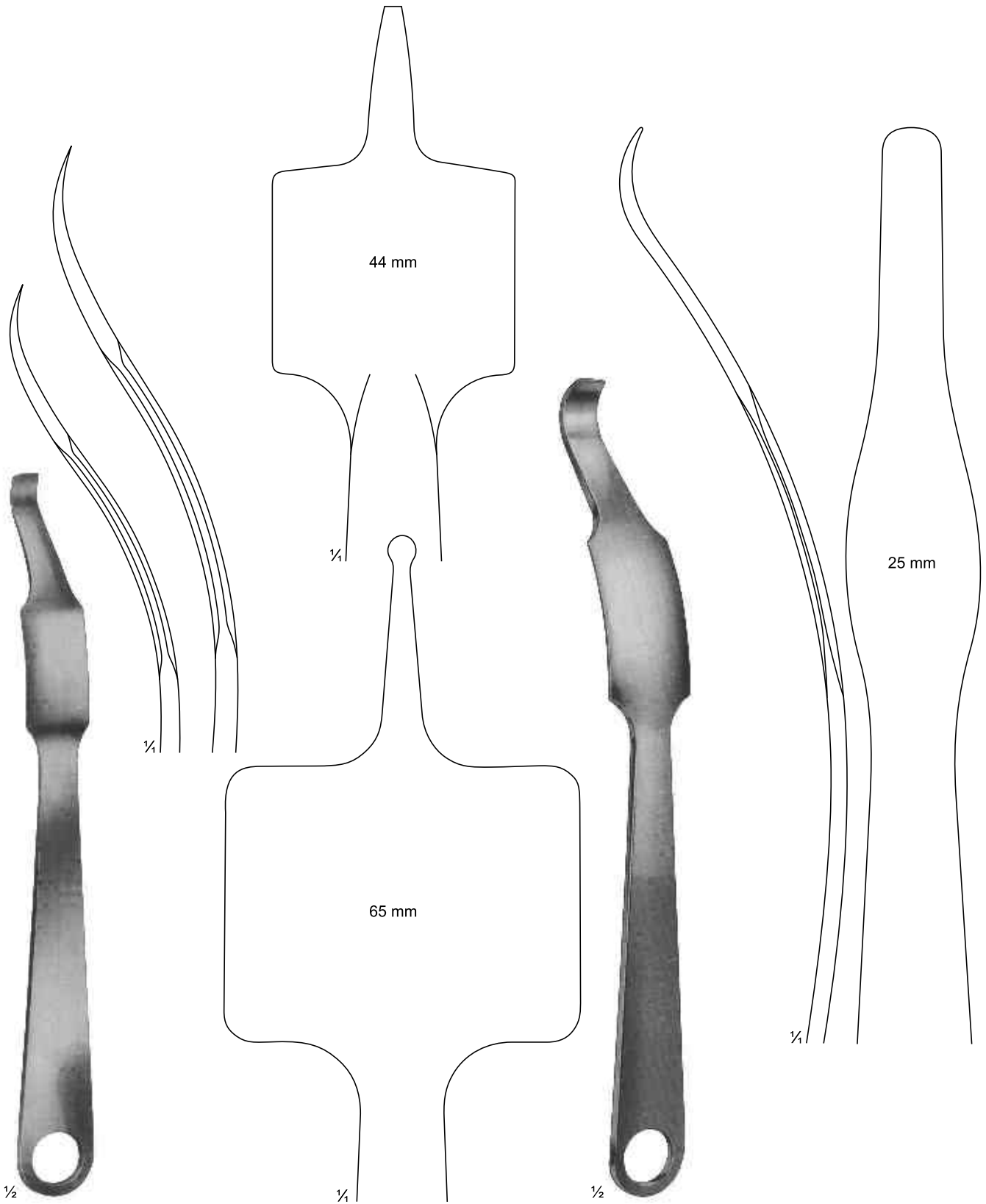

**20-125 - 126**  
**VERBRUGGE-MULLER**  
**20-125** 240 mm  
**20-126** 255 mm

**20-127**  
 260 mm

# Bone Levers

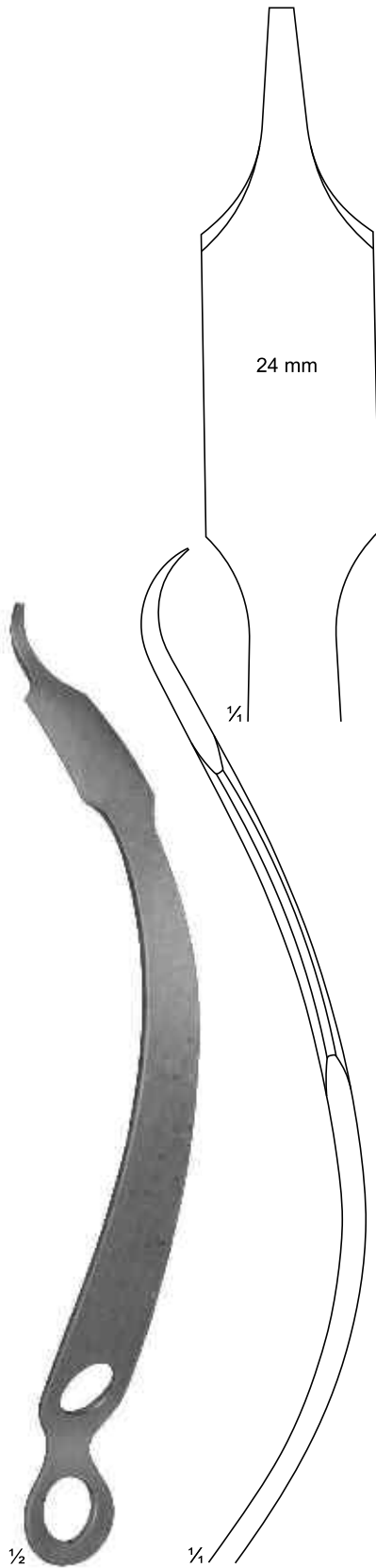

**20-128**  
HOHMANN-ALDINGER  
270 mm

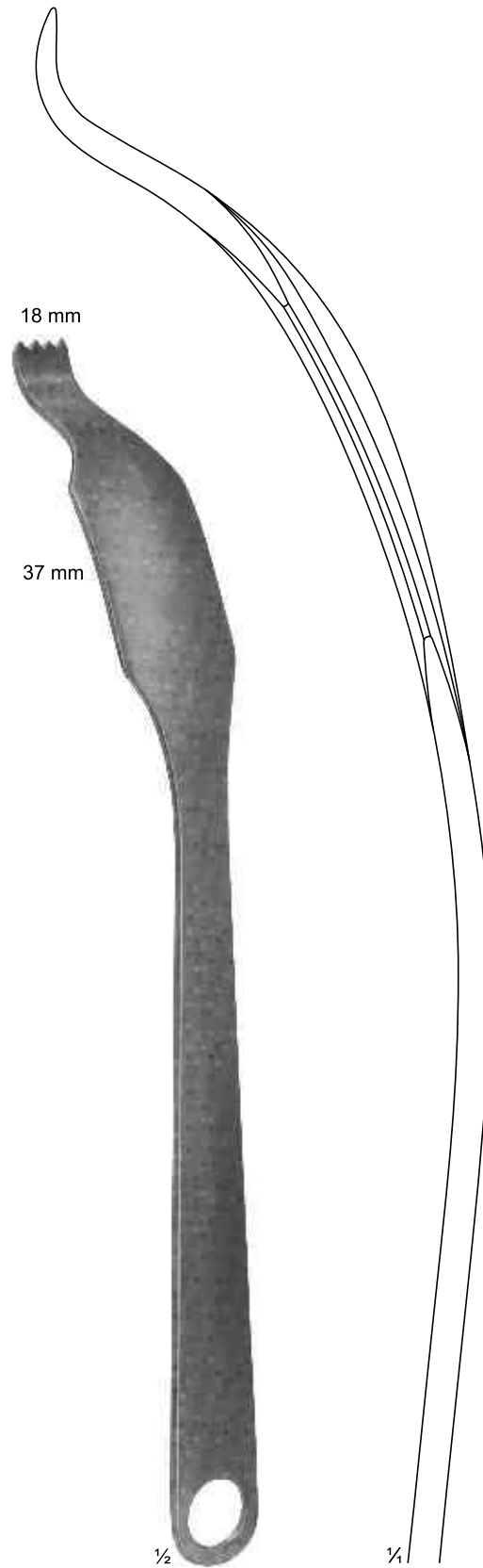

**20-129**  
SCHUMACHER mod. WAGNER  
345 mm

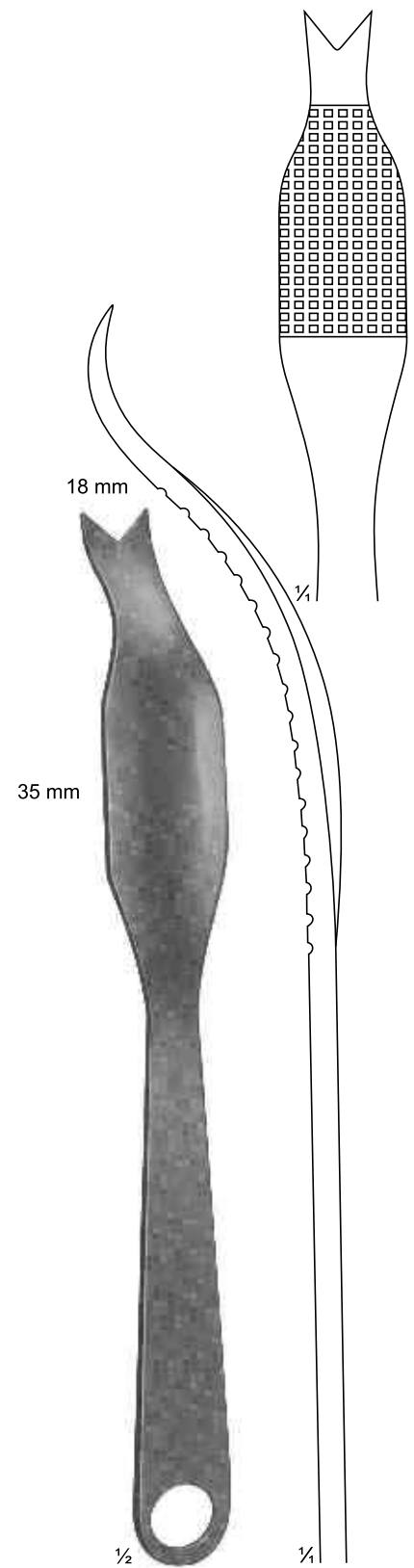

**20-130**  
SCHUMACHER  
290 mm

# Special Bone Levers

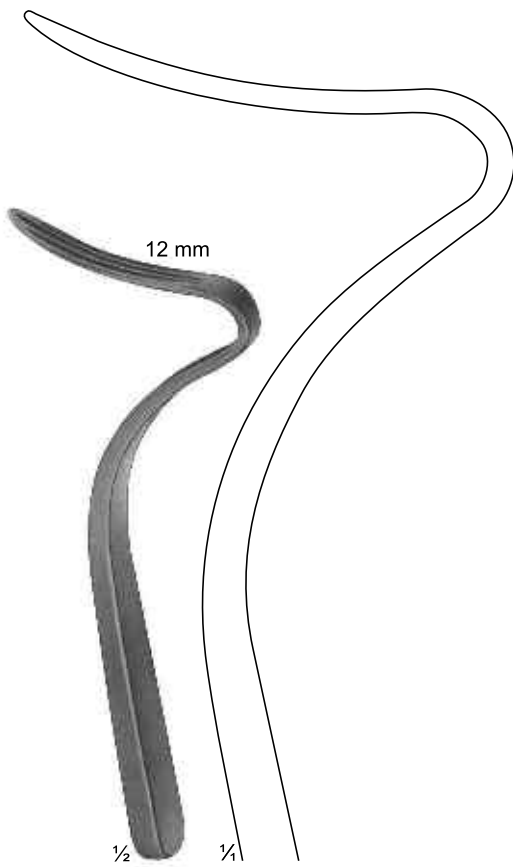

**20-131**  
**TAGER**  
 Bone lever for  
 angle joint operations  
 175 mm

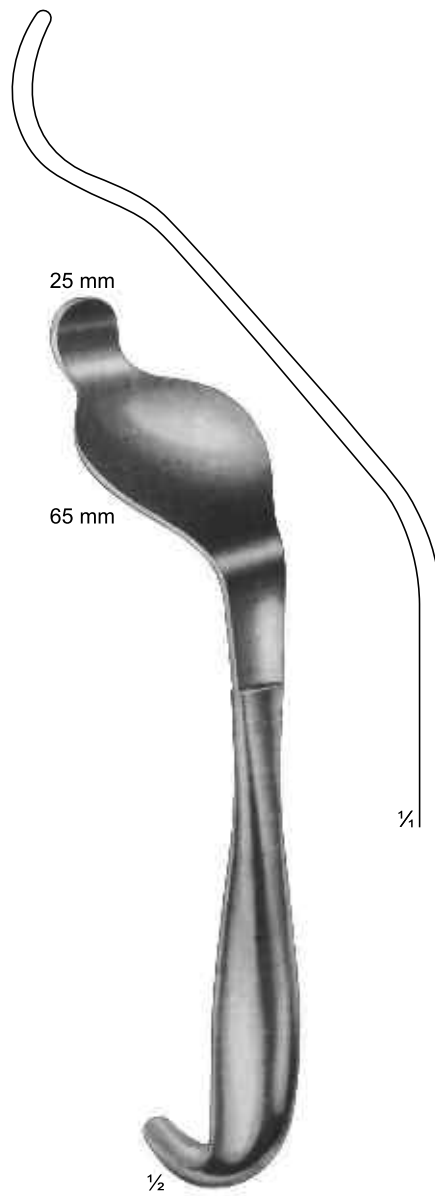

**20-132**  
**BENNETT**  
 235 mm

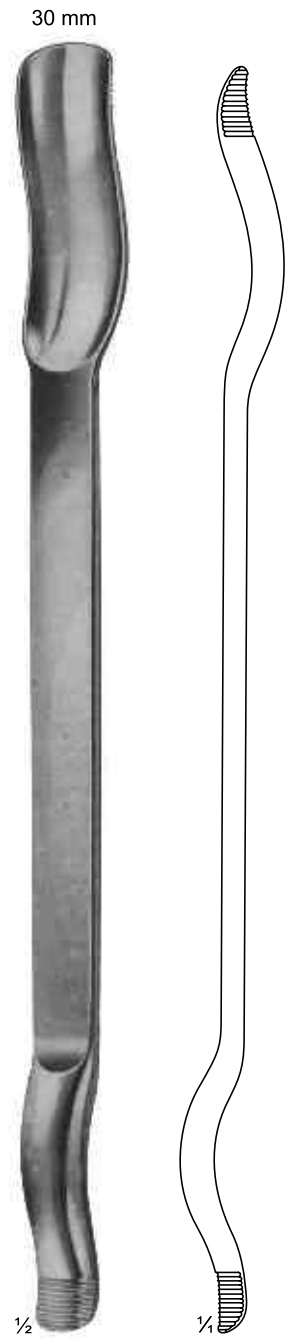

**20-133**  
**MURPHY-LANE**  
 Luxation lever  
 340 mm

# Raspatories



**20-134 - 135**  
PARTSCH  
150 mm

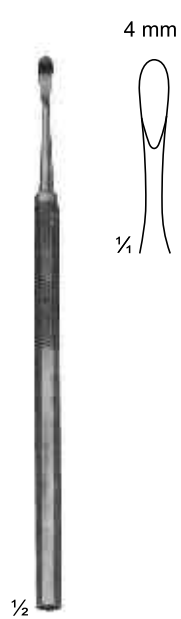

**20-136**  
PARTSCH mod. LANGE  
145 mm

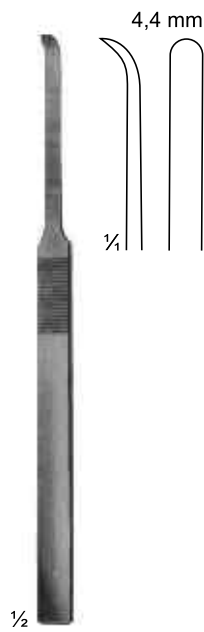

**20-137**  
MC KENTY  
155 mm

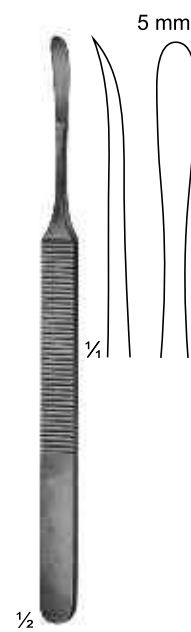

**20-138**  
KONIG  
155 mm

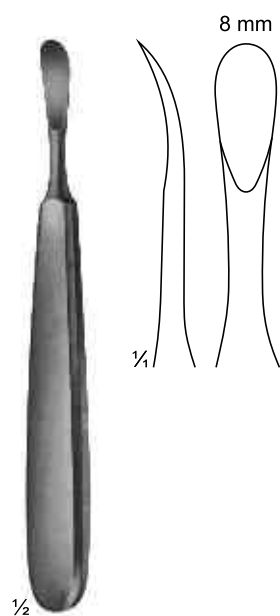

**20-139**  
TRELAT  
150 mm

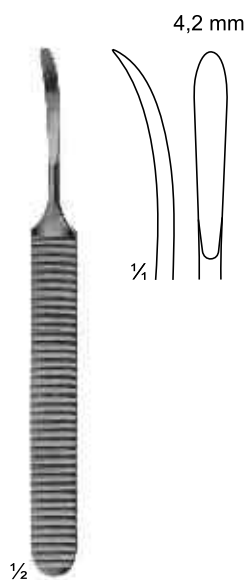

**20-140**  
WILLIGER  
140 mm

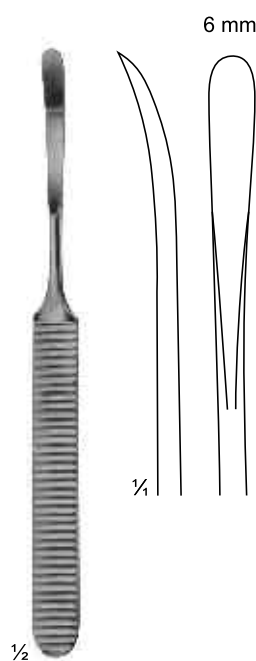

**20-141**  
WILLIGER  
160 mm

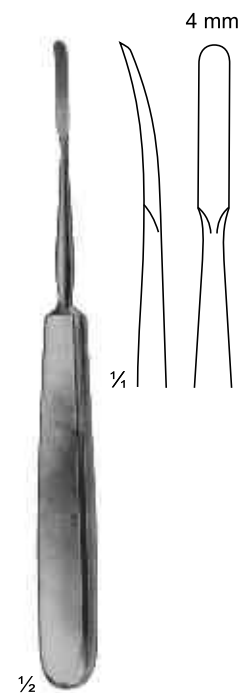

**20-142**  
JOSEPH  
170 mm

# Raspatories

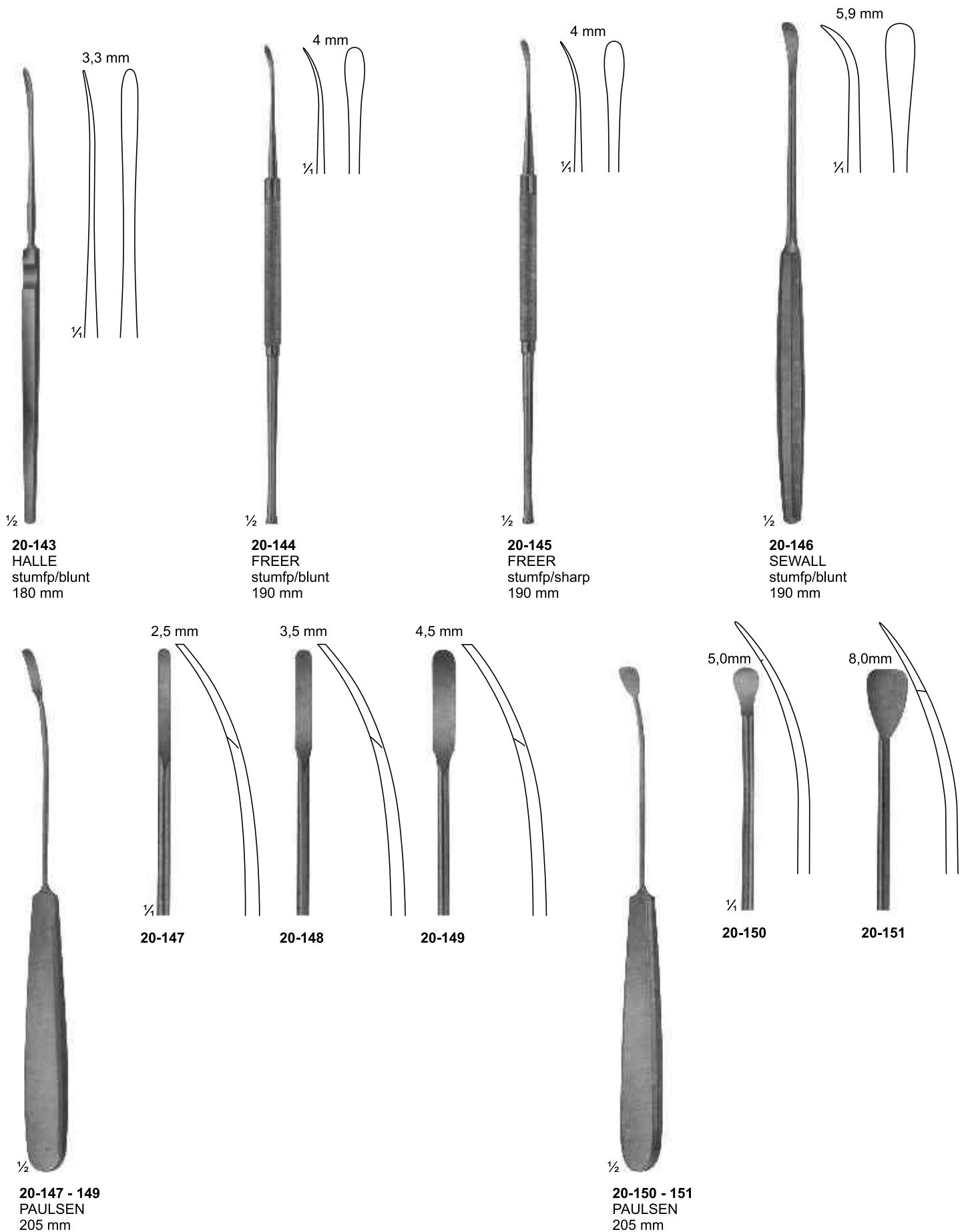

# Raspatories

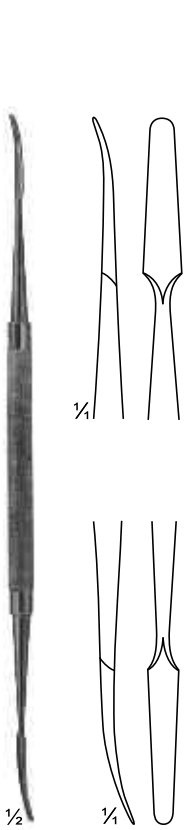

**20-152**  
KILLIAN  
sharp/blunt  
185 mm

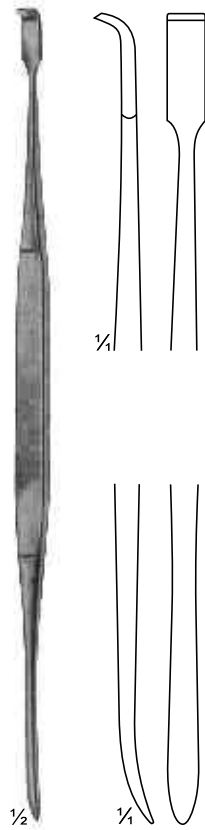

**20-153**  
HOWARTH  
sharp/blunt  
215 mm

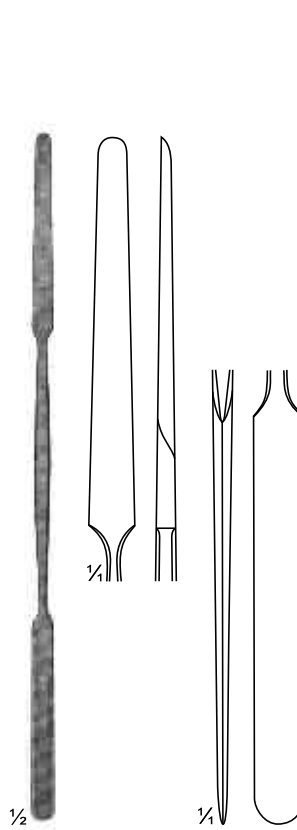

**20-154**  
KILLIAN  
sharp/blunt  
185 mm

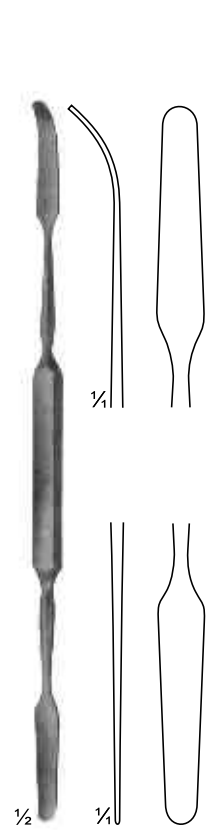

**20-155**  
MAC DONALD  
blunt/blunt  
185 mm

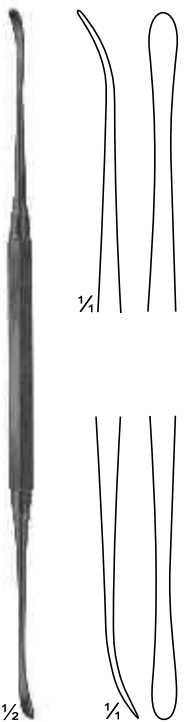

**20-156**  
FREER  
sharp/blunt  
185 mm

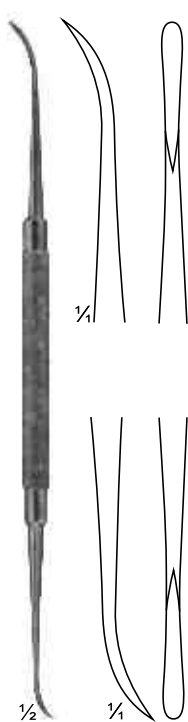

**20-157**  
FREER-YASARGIL  
sharp/sharp  
185 mm

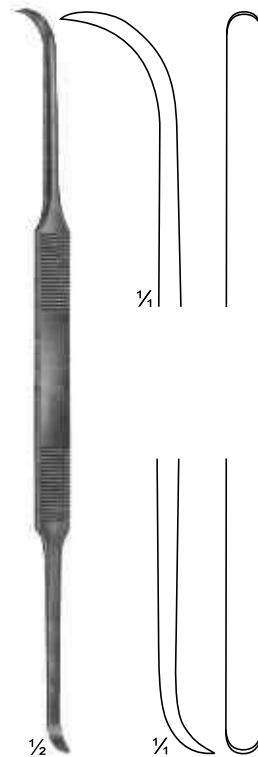

**20-158**  
COTTLE  
sharp/sharp  
200 mm



**20-159**  
MEAD  
sharp/sharp  
165 mm

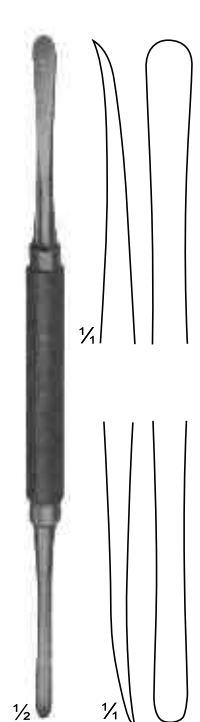

**20-160**  
MOLT  
sharp/sharp  
180 mm

# Raspatories

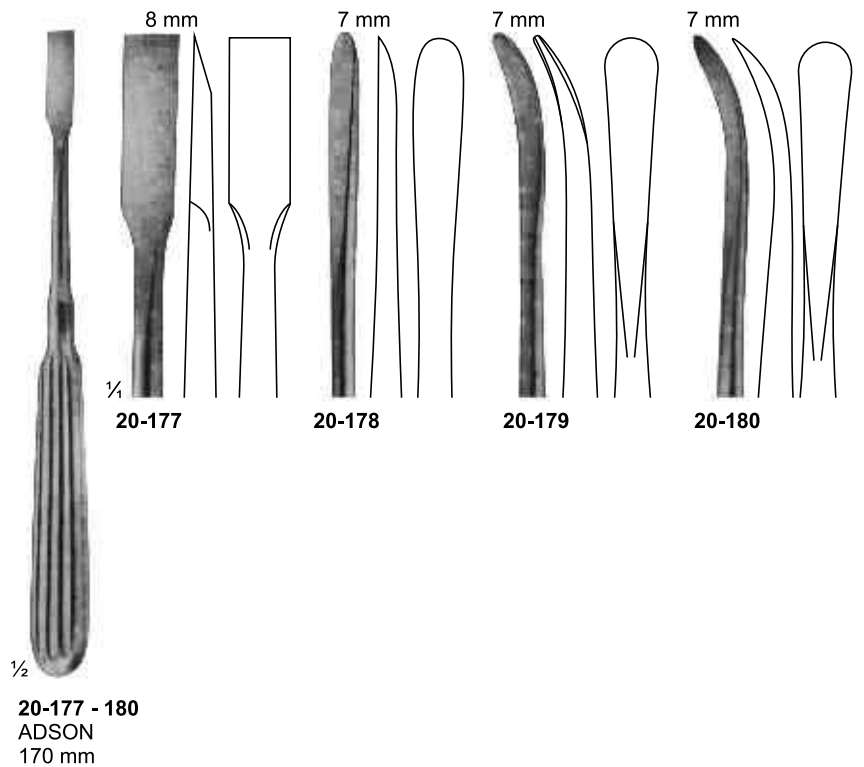
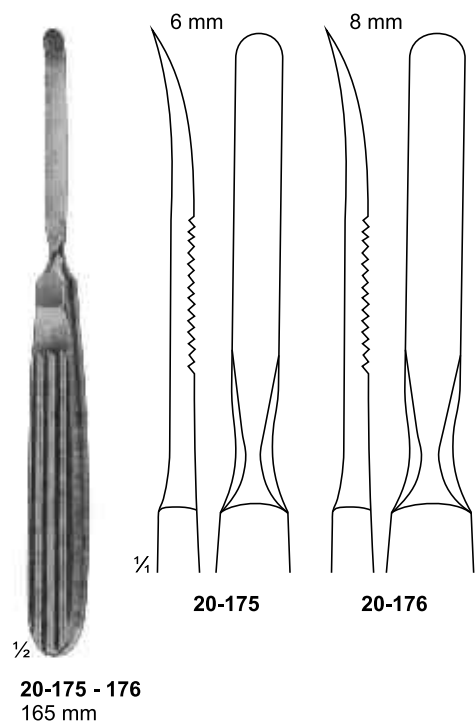
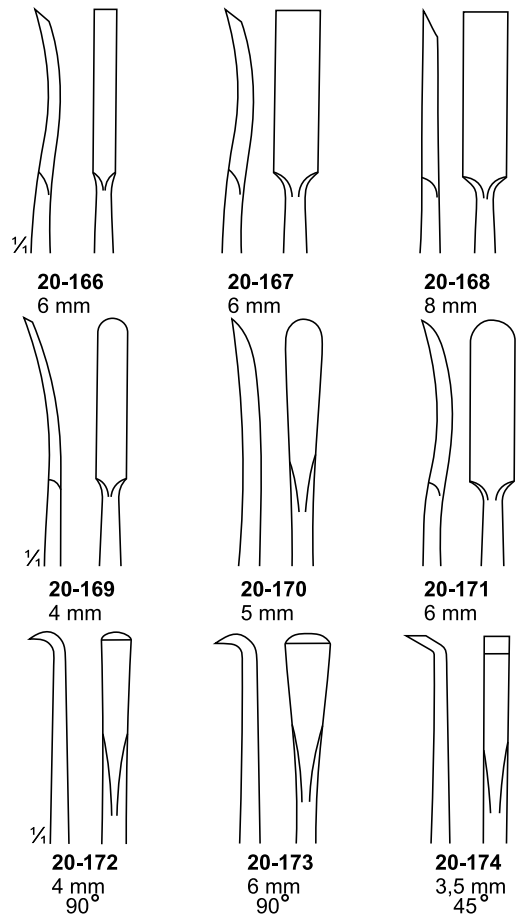
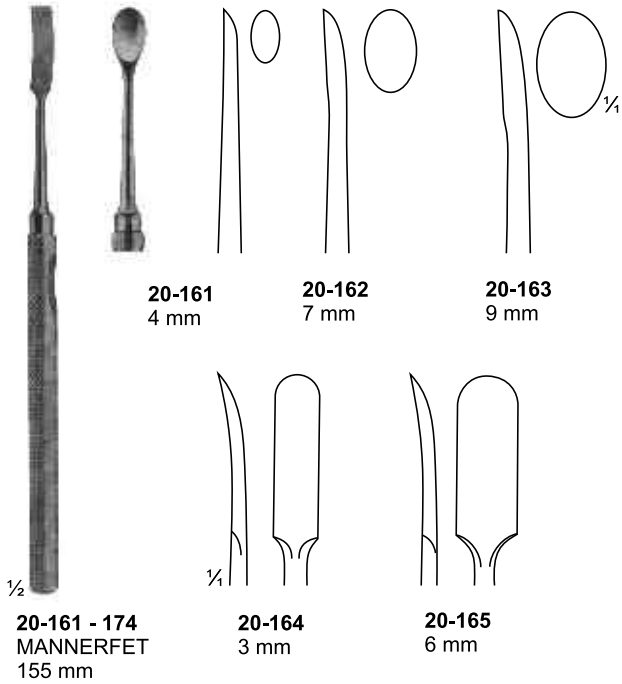

# Raspatories

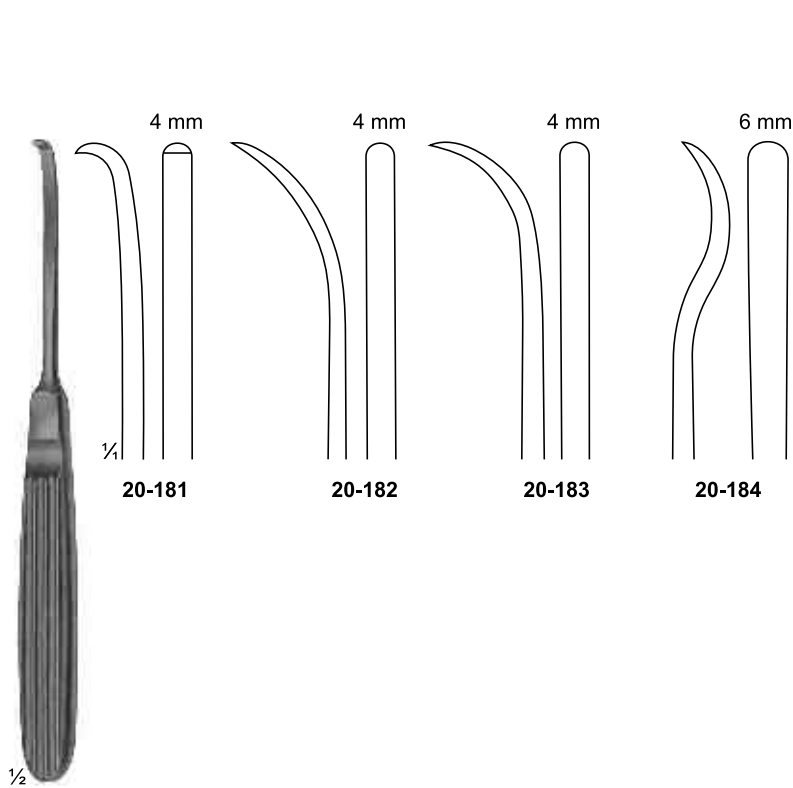

20-181

20-182

20-183

20-184

1/2  
20-181 - 184  
MUHLING  
170 mm

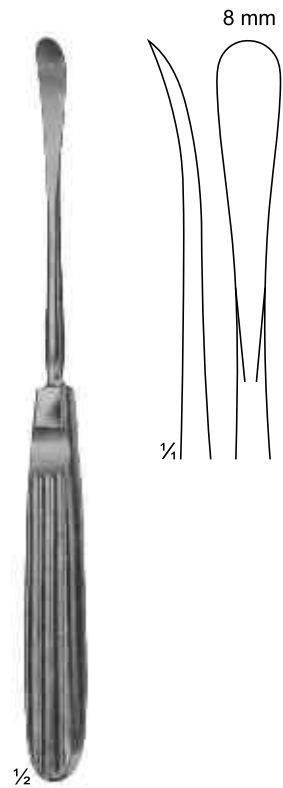

1/2  
20-185  
COTTLE  
175 mm

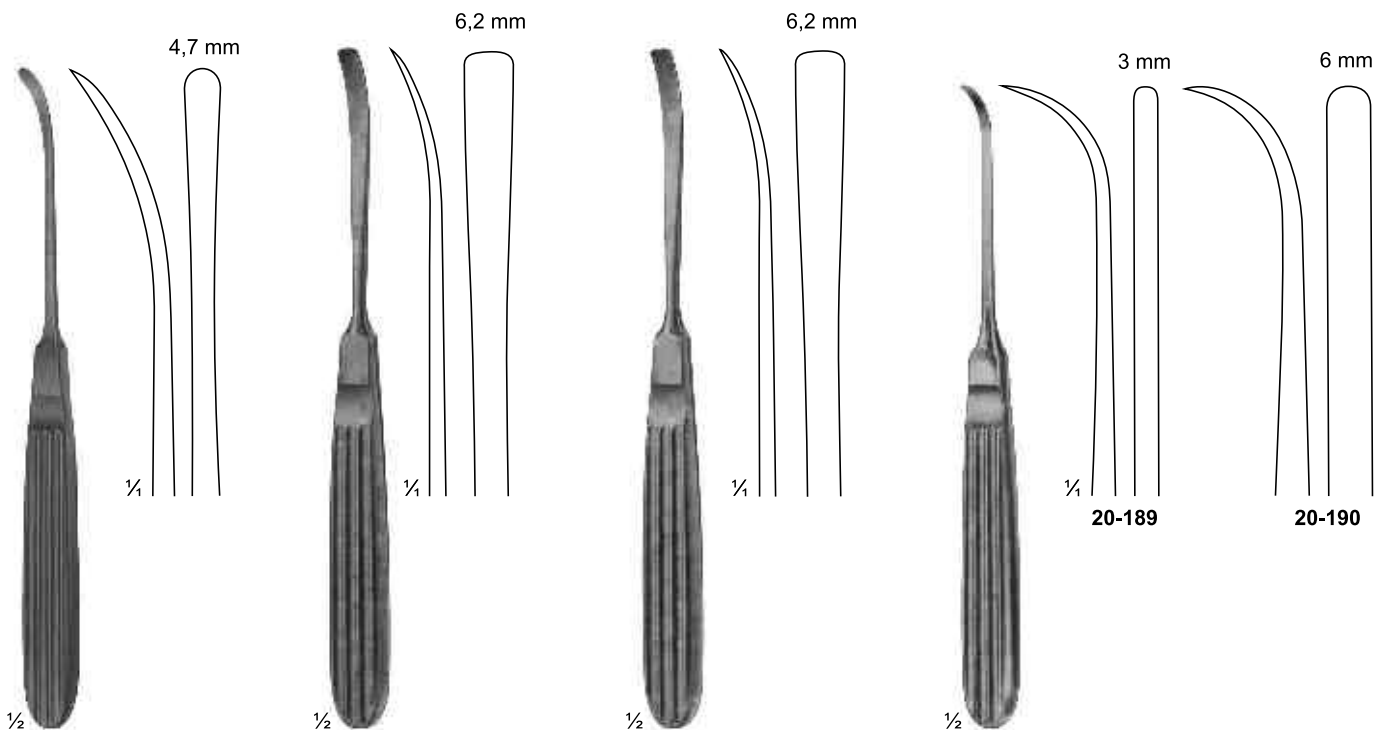

1/2  
20-186  
LANDOT  
175 mm

1/2  
20-187  
CASPER  
180 mm

1/2  
20-188  
CASPER  
180 mm

1/2  
20-189 - 190  
170 mm



# Raspatories

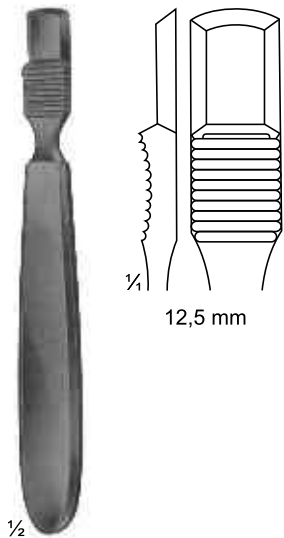

**20-191**  
FARABEUF  
140 mm

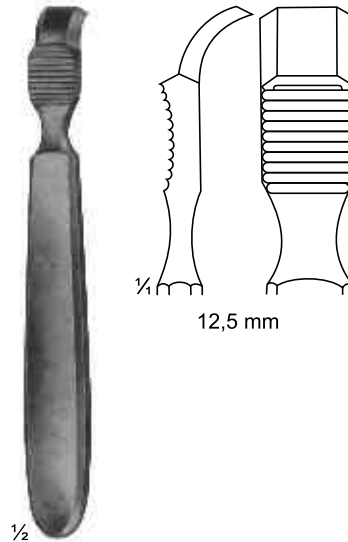

**20-192**  
FARABEUF  
140 mm

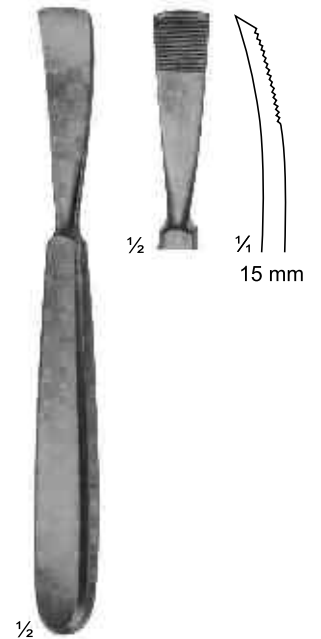

**20-193**  
JANSEN  
165 mm

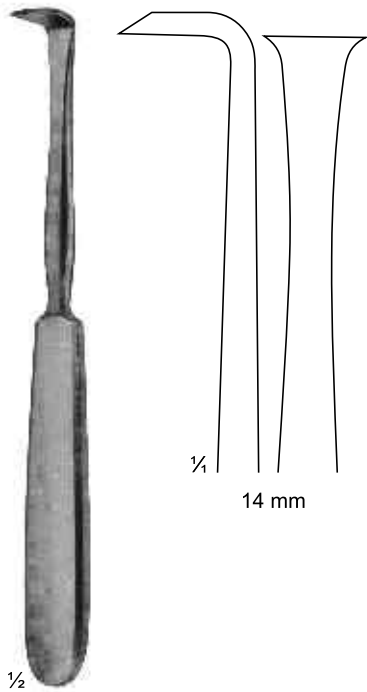

**20-194**  
LANGENBACK  
180 mm

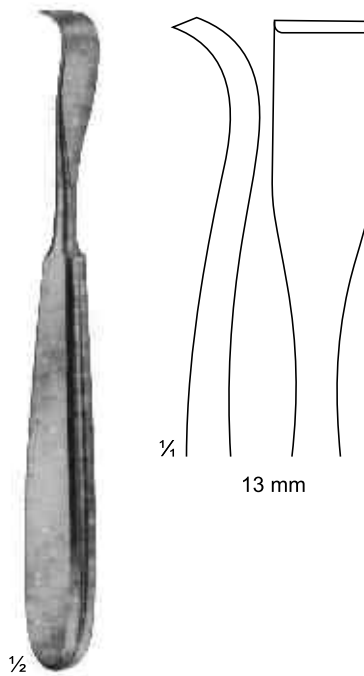

**20-195**  
SCHNEIDER  
175 mm

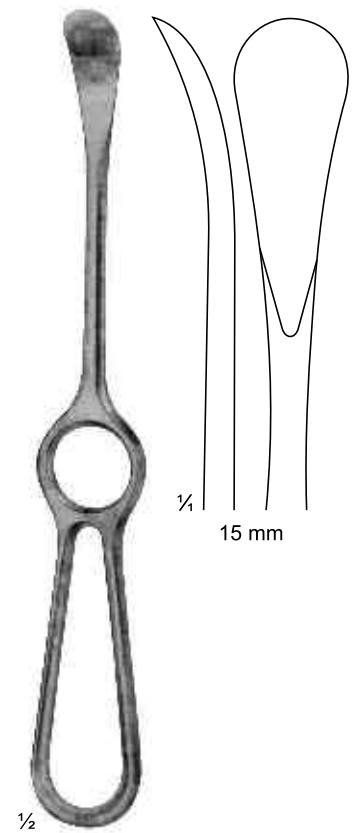

**20-196**  
SEDILLOT  
215 mm

# Raspatories

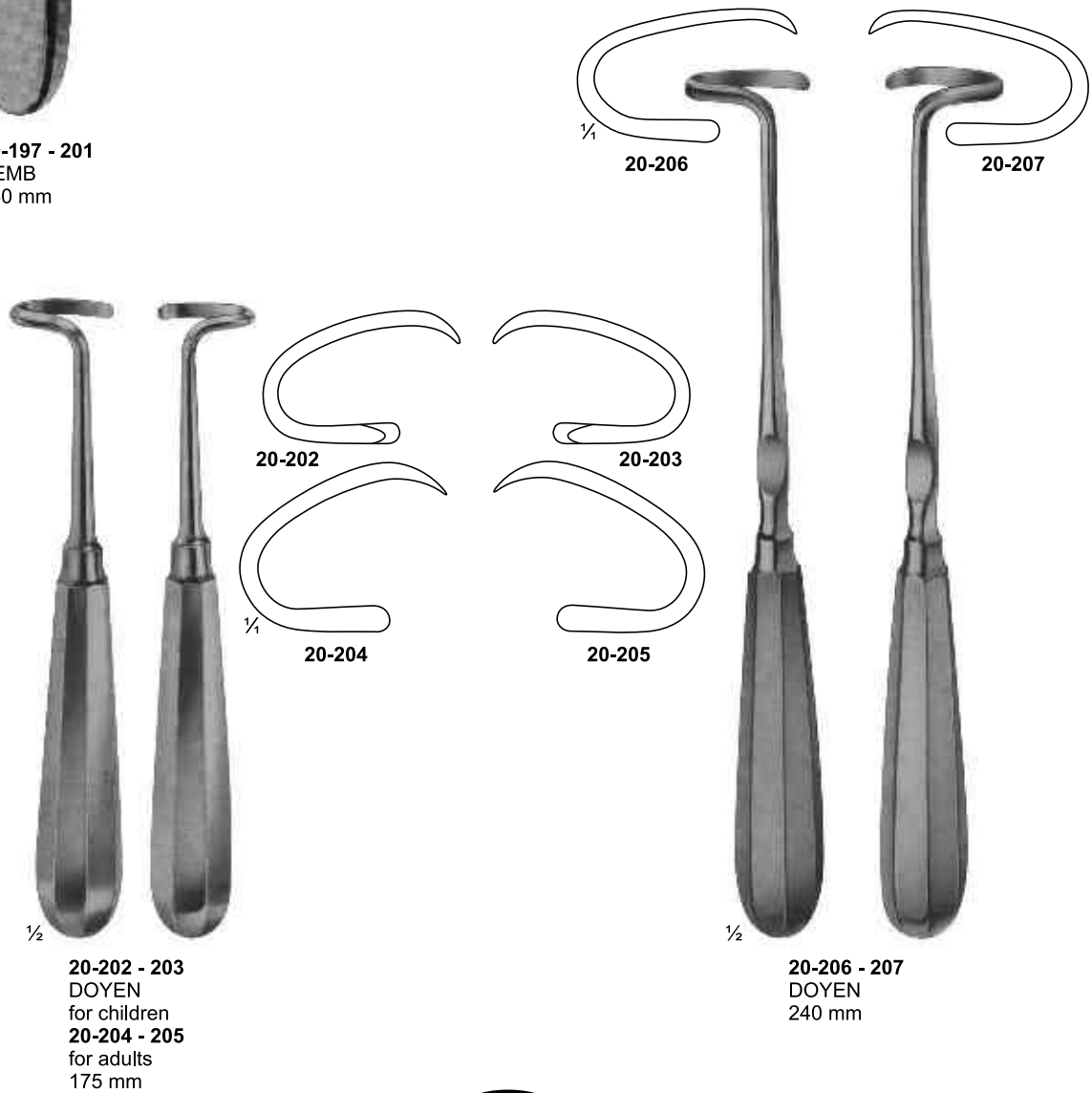
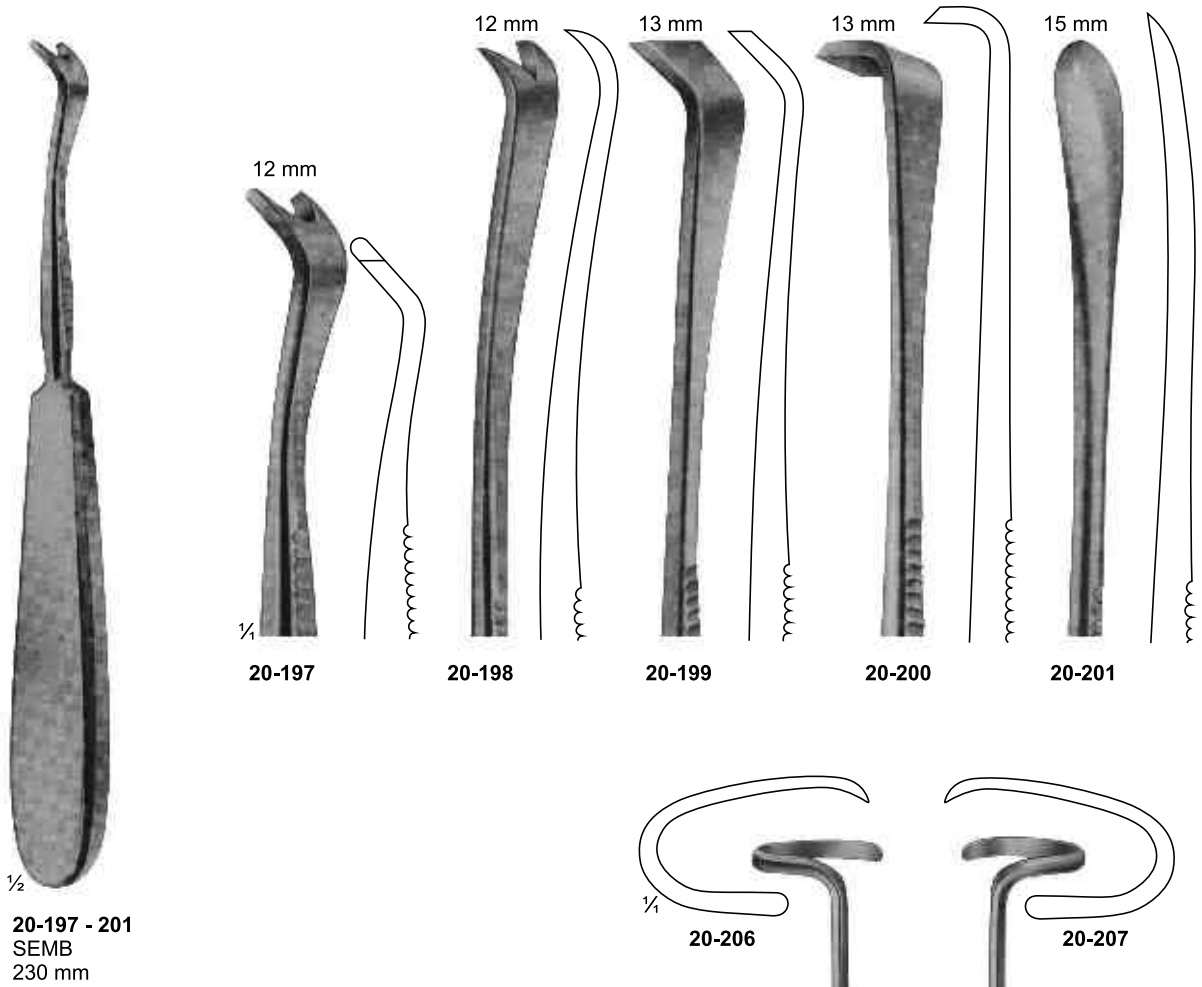

# Raspatories with HARTPRESS-handle

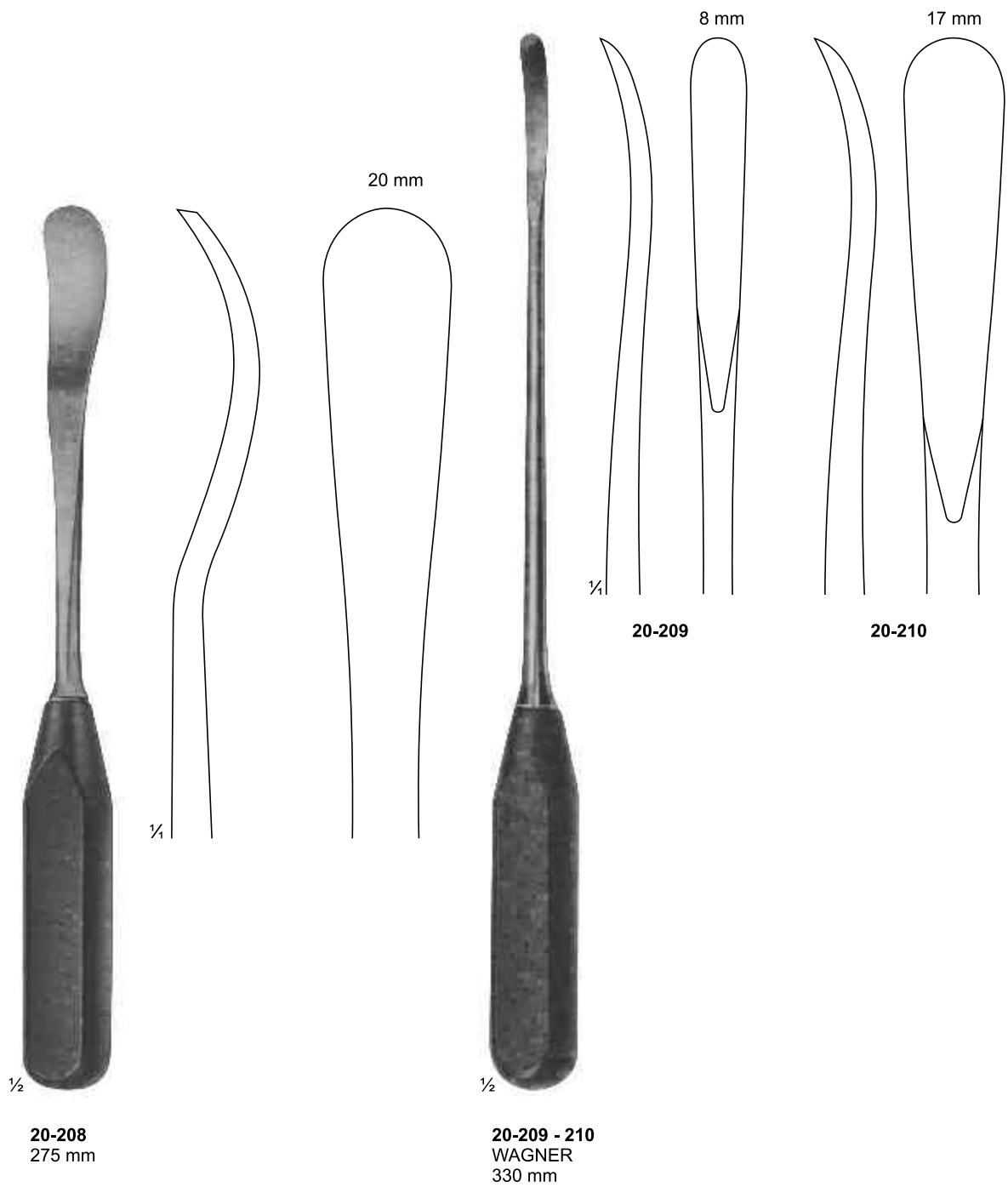

# Bone File and Rasps

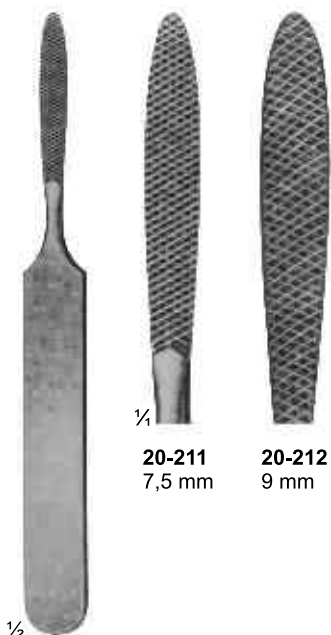

¼  
**20-211**  
 7,5 mm

**20-212**  
 9 mm

½  
**20-211**  
 JOSEPH  
 fine, chequered

**20-212**  
 coarse, chequered  
 165 mm

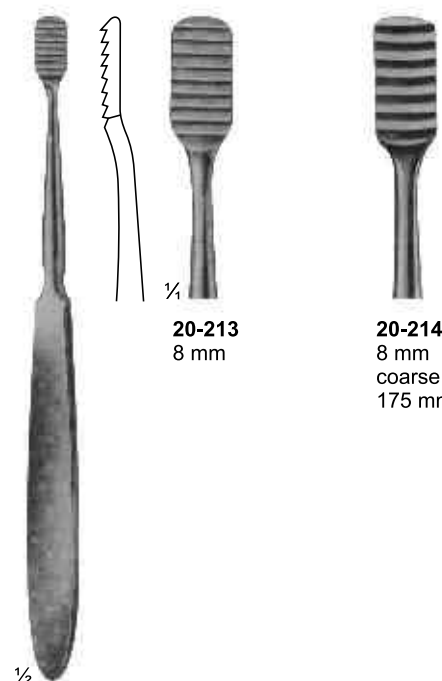

¼  
**20-213**  
 8 mm

**20-214**  
 8 mm  
 coarse, teeth  
 175 mm

½  
**20-213**  
 LEWIS  
 fine, teeth



¼  
 9 mm

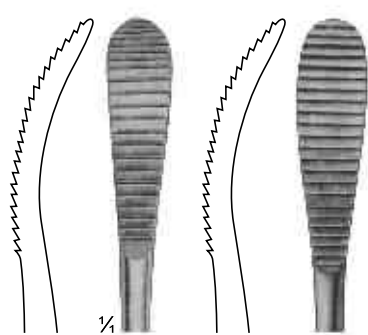

¼  
**20-216**  
 9 mm

**20-217**  
 9 mm

½  
**20-215**  
 MALTZ  
 down stroke  
 180 mm



½  
**20-216**  
 AUFRICHT  
 up stroke  
**20-217**  
 down stroke  
 220 mm



¼  
**20-218**  
 GALLAHER  
 190 mm

# Bone File and Rasps

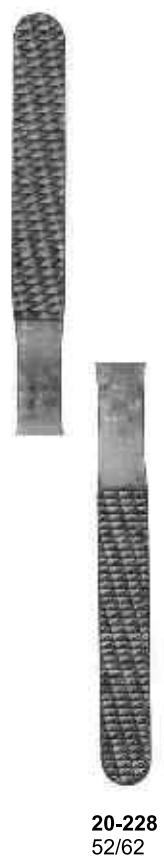
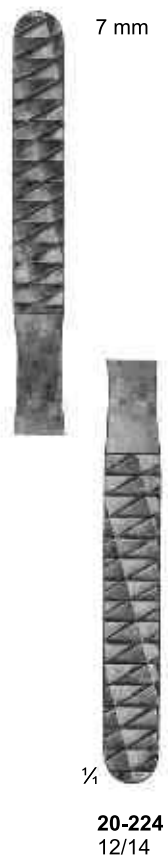
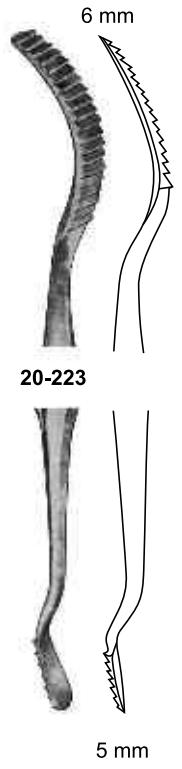
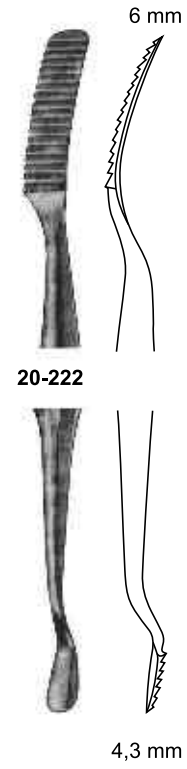
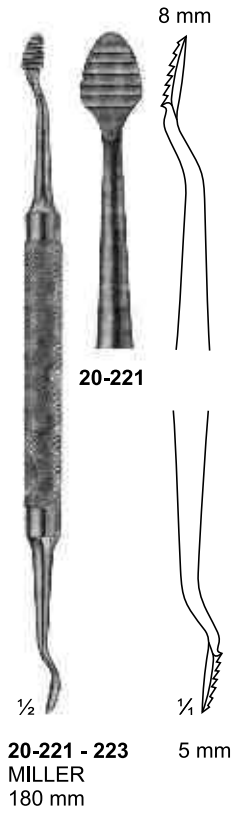
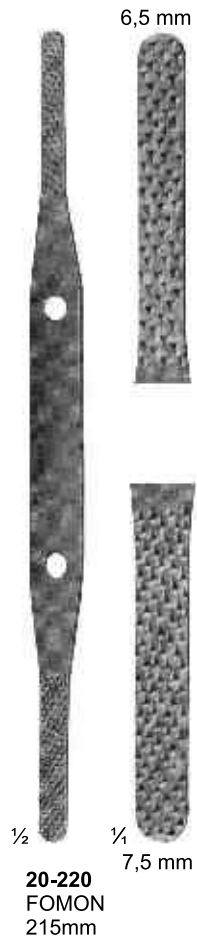

# Bone File and Rasps

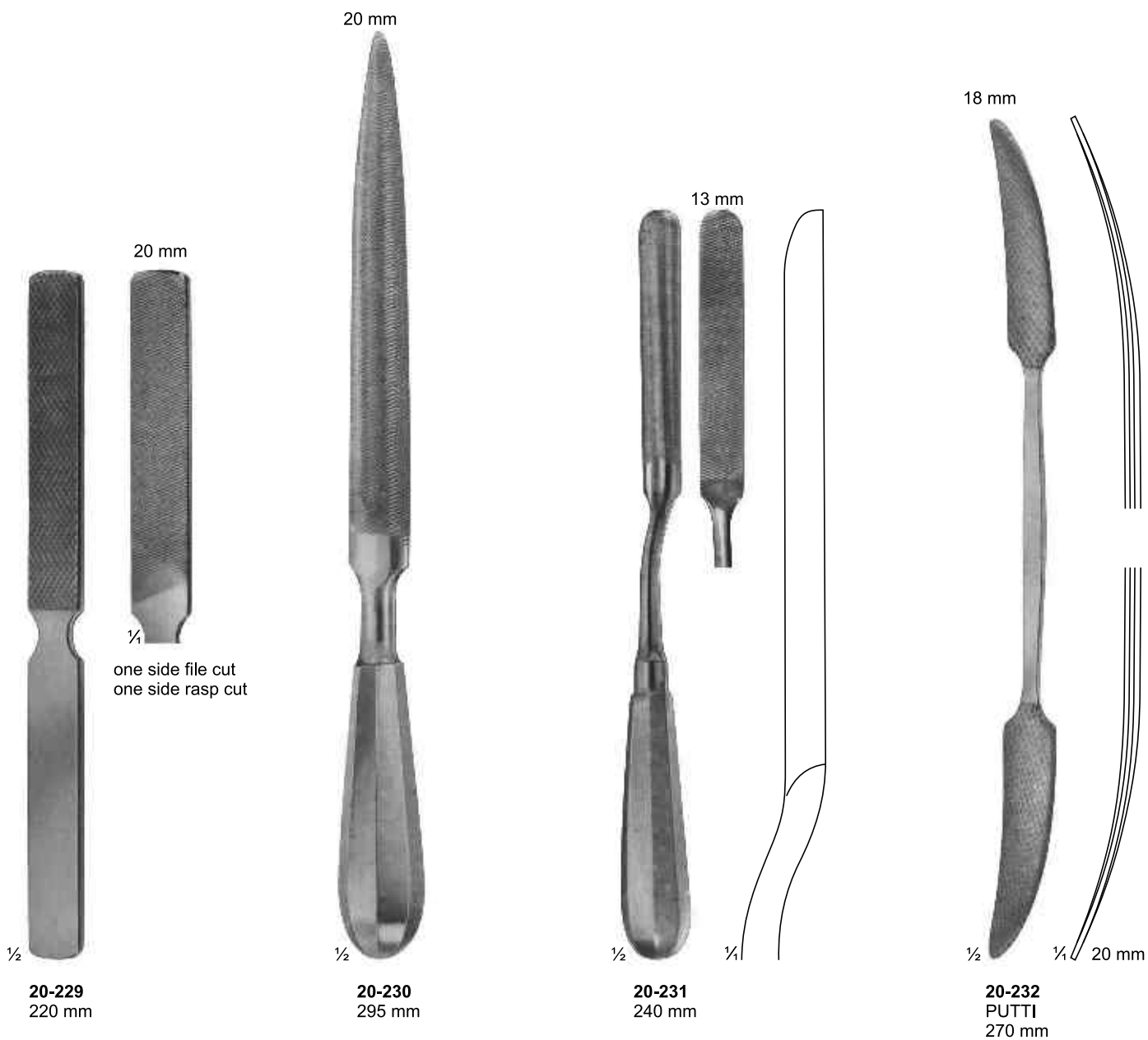

# Bone Curettes



**20-233**  
JACOBSON  
140 mm

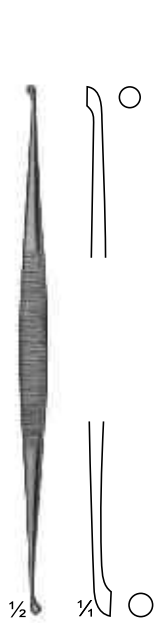

**20-234**  
MARTINI  
140 mm

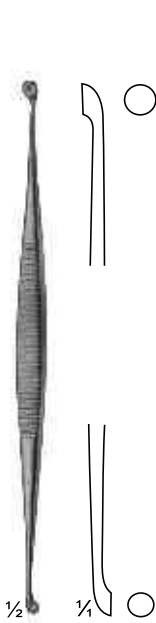

**20-235**  
MARTINI  
140 mm



**20-236**  
WILLIGER  
145 mm



**20-237**  
JANSEN  
160 mm



**20-238**  
BARTH  
180 mm

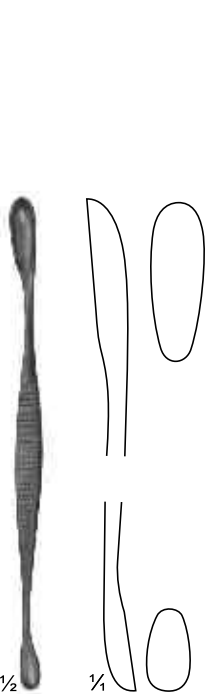

**20-239**  
VOLKMANN  
130 mm

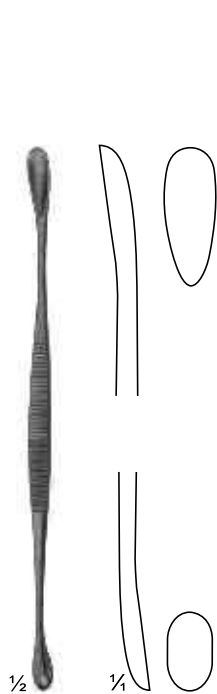

**20-240**  
VOLKMANN  
145 mm

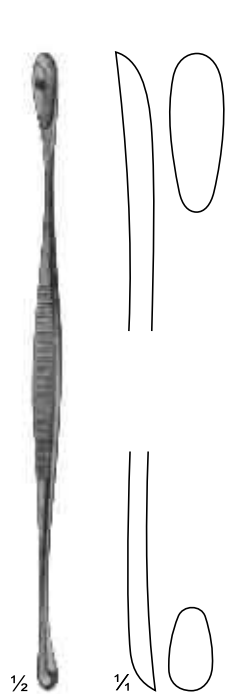

**20-241**  
VOLKMANN  
170 mm

# Bone Curettes



**20-242**  
JANSEN  
160 mm



**20-243**  
HEMINGWAY  
170 mm



**20-244**  
HEMINGWAY  
175 mm



**20-245**  
LUCAS  
180 mm



**20-246**  
LUCAS  
185 mm

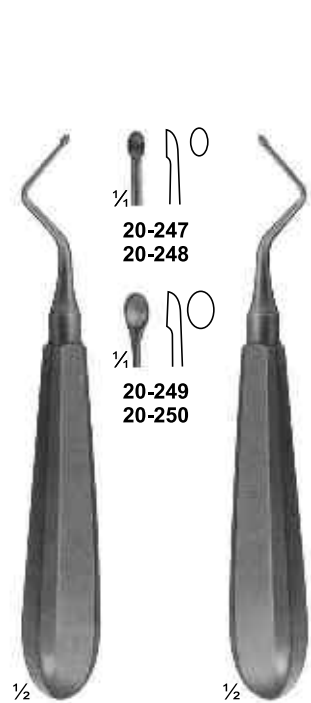

**20-247 - 248**  
KERPEL  
145 mm

**20-249 - 250**  
KERPEL  
145 mm

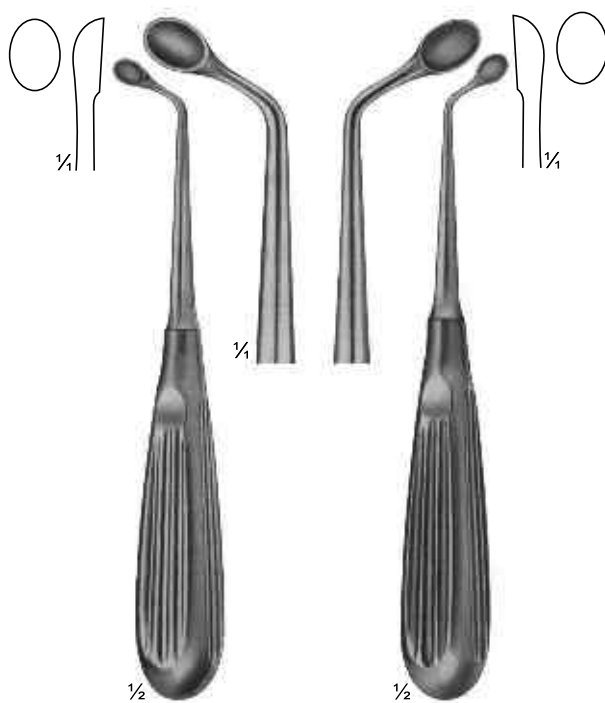

**20-251**  
UFFENORDE  
170 mm

**20-252**  
UFFENORDE  
170 mm



# Bone Currettes



1/2

**20-253 - 259**  
BRUNS  
165 mm



**20-253**  
3 mm  
Fig: 000



**20-254**  
4 mm  
00



**20-255**  
5 mm  
0



**20-256**  
6 mm  
Fig: 1



**20-257**  
8 mm  
2



**20-258**  
10 mm  
3



**20-259**  
12 mm  
4



**20-260**  
2,5 mm  
Fig: 000



**20-261**  
3,4 mm  
00



**20-262**  
4,2 mm  
0



**20-263**  
5,2 mm  
Fig: 1



**20-264**  
6,3 mm  
2



**20-265**  
7,4 mm  
3



**20-266**  
8 mm  
4



1/2

**20-260 - 266**  
SCHEDE  
170 mm



1/2

**20-267 - 276**  
VOLKMANN  
170 mm



**20-267**  
2,8 mm  
Fig: 0000



**20-268**  
3,6 mm  
000



**20-269**  
4,4 mm  
00



**20-270**  
5,2 mm  
0



**20-271**  
6,8 mm  
1



**20-272**  
8,5 mm  
Fig: 2



**20-273**  
10 mm  
3

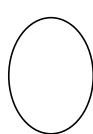

**20-274**  
11,5 mm  
4

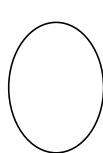

**20-275**  
13 mm  
5

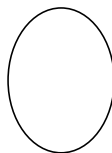

**20-276**  
14,5 mm  
6



**20-277**  
3,4 mm  
Fig: 00



**20-278**  
5,2 mm  
1



1/2

**20-277 - 278**  
WILLIGER  
170 mm

# Bone Curettes

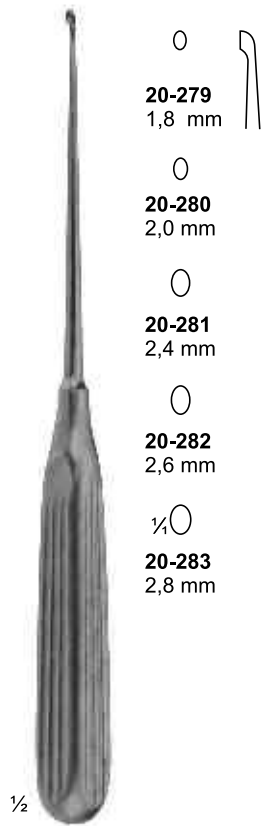

- **20-279**  
1,8 mm
- **20-280**  
2,0 mm
- **20-281**  
2,4 mm
- **20-282**  
2,6 mm
- ¼○  
**20-283**  
2,8 mm

**20-279 - 283**  
LEMPERT  
215 mm

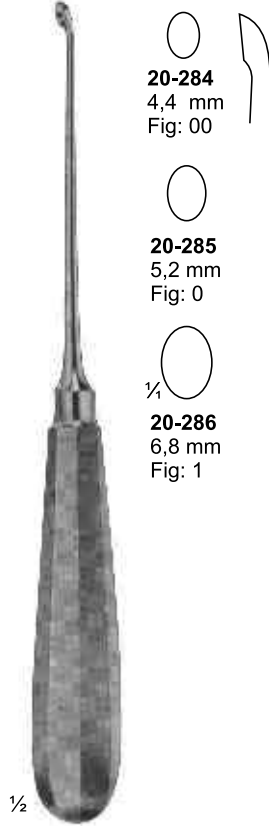

- **20-284**  
4,4 mm  
Fig: 00
- **20-285**  
5,2 mm  
Fig: 0
- ¼○  
**20-286**  
6,8 mm  
Fig: 1

**20-284 - 286**  
HALLE  
215 mm

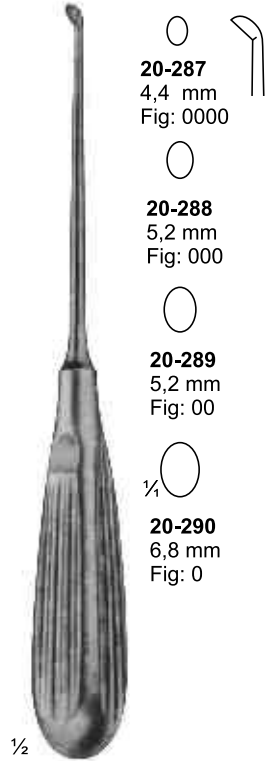

- **20-287**  
4,4 mm  
Fig: 0000
- **20-288**  
5,2 mm  
Fig: 000
- **20-289**  
5,2 mm  
Fig: 00
- ¼○  
**20-290**  
6,8 mm  
Fig: 0

**20-287 - 290**  
DAUBENSPECK  
200 mm



- **20-291**  
3,6 mm  
Fig: 000
- **20-292**  
4,4 mm  
Fig: 00
- **20-293**  
5,2 mm  
Fig: 0
- ¼○  
**20-294**  
6,8 mm  
Fig: 1

**20-291 - 294**  
250 mm



- **20-295**  
3,6 mm  
Fig: 000
- **20-296**  
4,4 mm  
Fig: 00
- **20-297**  
5,2 mm  
Fig: 0
- ¼○  
**20-298**  
6,8 mm  
Fig: 1

**20-295 - 298**  
250 mm



- **20-299**  
3 mm
- **20-300**  
4 mm
- ¼○  
**20-301**  
5 mm

**20-299 - 301**  
BUSHE  
250 mm

# Bone Currettes

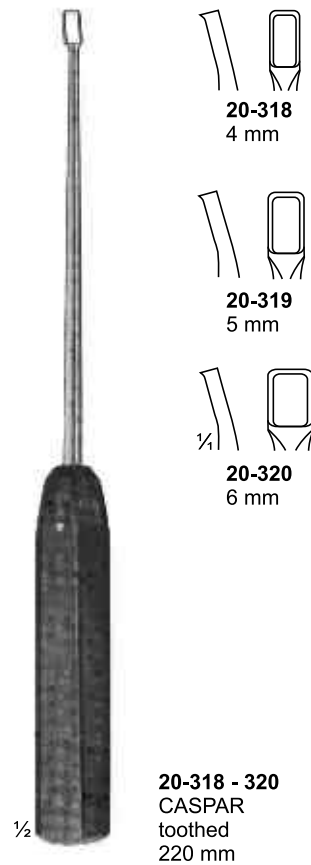
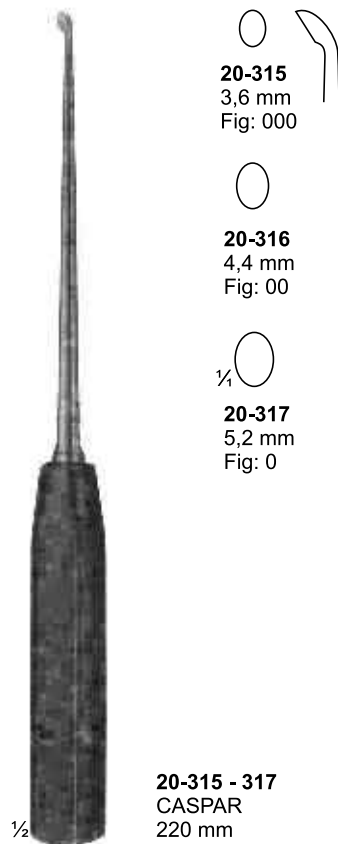
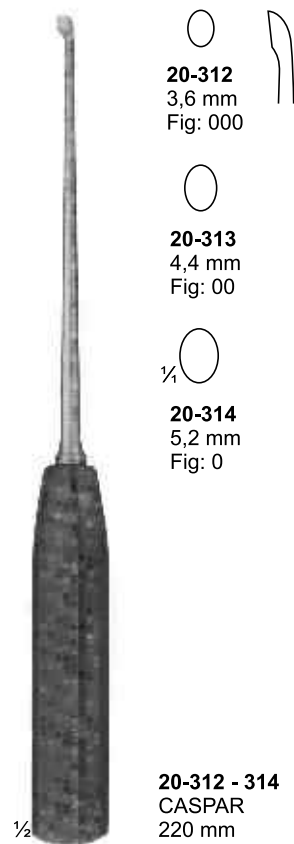
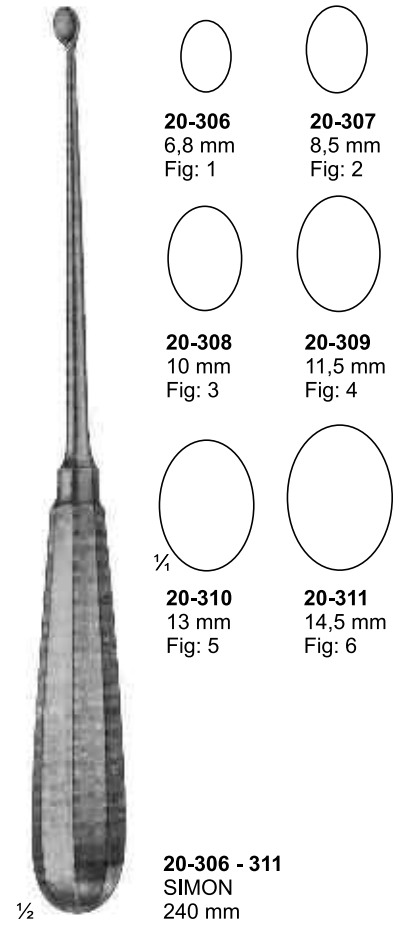
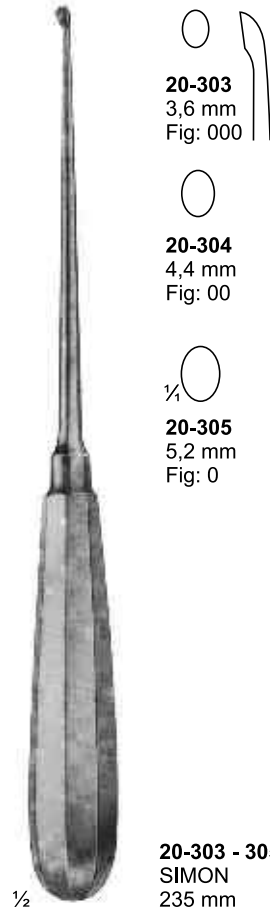

# Bone Curettes

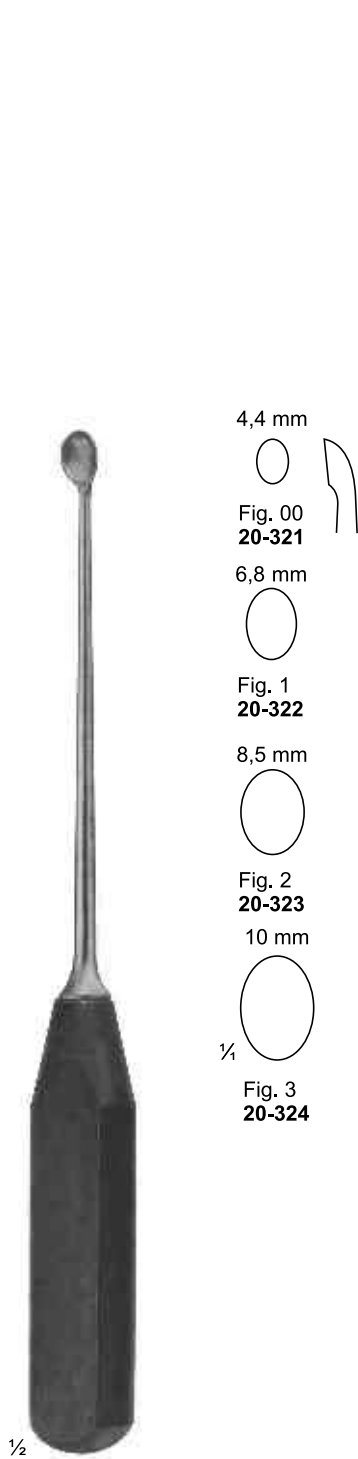

**20-321 - 324**  
270 mm

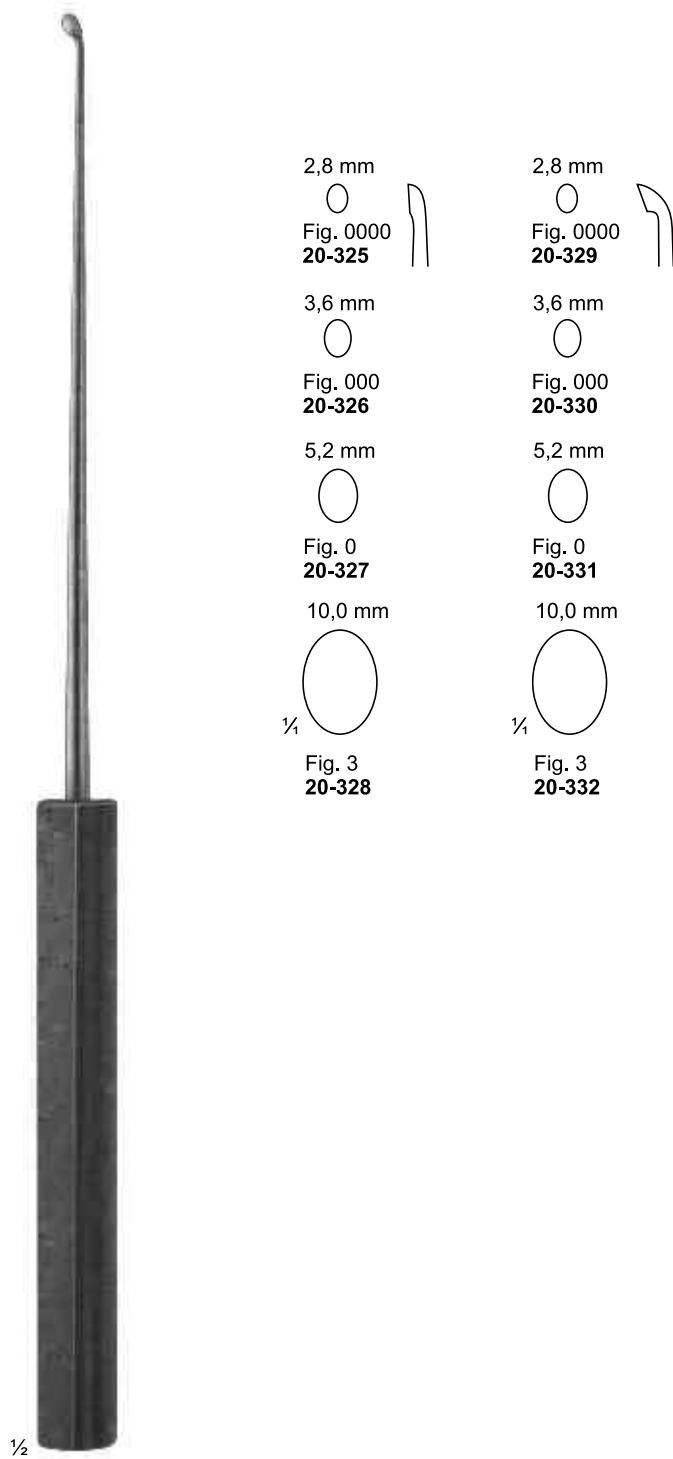

**20-325 - 332**  
SYPERT  
380 mm

# Mallets



Ø 20 mm

1/2

**21-101**  
MEAD  
185 g  
with interchangeable  
plastic disks  
190 mm  
**21-102**  
pair of spare disks



1/2

**21-103**  
140 g  
with interchangeable  
plastic disks  
185 mm  
**21-104**  
pair of spare disks



Ø 25 mm

1/2

**21-105**  
COTTLE  
140 g  
1 Seite convex  
1 Side convex  
185 mm



Ø 22 mm

1/2

**21-106**  
165 g  
lead filled head  
190 mm

# Mallets



**21-107**  
HAJEK  
140 g  
215 mm



**21-108**  
215 g  
with interchangeable  
plastic disks  
245 mm  
**21-109**  
pair of spare disks

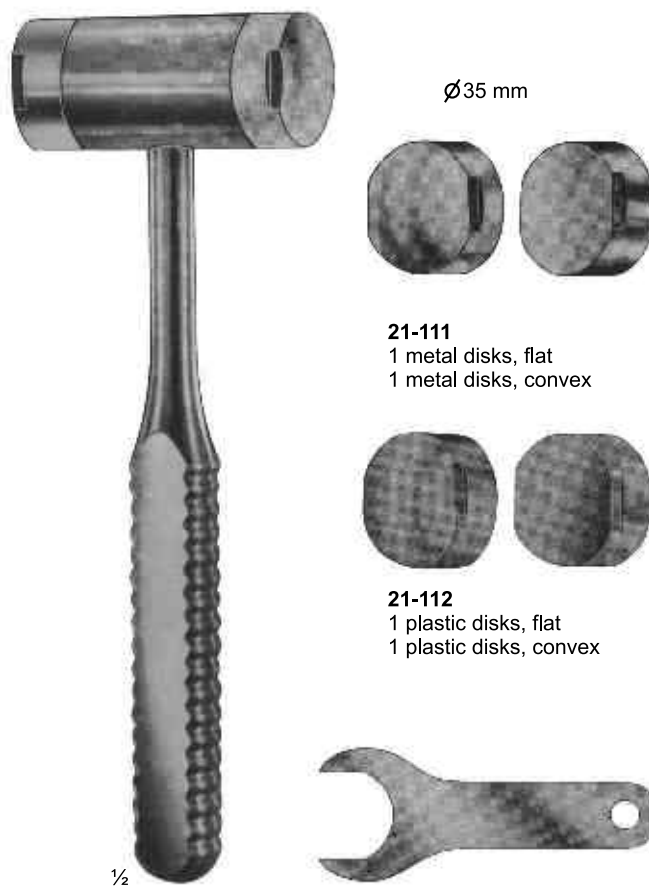

**21-110 - 113**  
WAGNER  
complete with:  
1 pair of metal disks and  
1 pair of plastic disks and  
1 wrench 566  
235 mm

Ø 35 mm

**21-111**  
1 metal disks, flat  
1 metal disks, convex

**21-112**  
1 plastic disks, flat  
1 plastic disks, convex

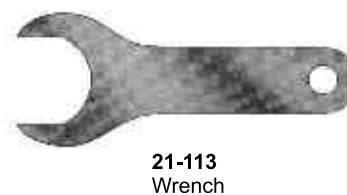

**21-113**  
Wrench  
Mallet without disks 130 g

# Mallets



**21-114**  
BERGMANN  
245 mm



**21-115**  
BERGMANN  
235 mm



**21-116**  
OMBREDANNE  
240 mm

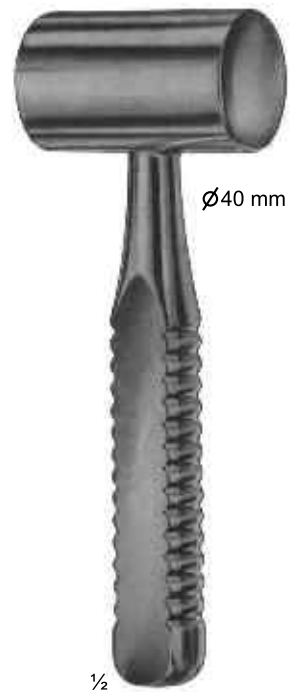

**21-117**  
HEATH  
copper filled head  
700 g  
185 mm

# Tampers - Osteotomes, Chisels and Gouges

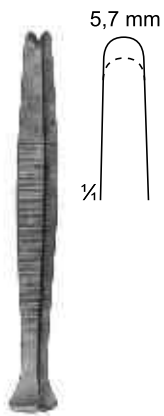

**21-118**  
Haase  
100 mm



**21-119 - 120**  
PASSOW  
120 mm

□  
**21-119**  
5,7 mm  
¼ □  
**21-120**  
3,5 mm



**21-121 - 123**  
CASPER  
200 mm

●  
**21-121**  
∅3 mm  
●  
**21-122**  
∅5 mm  
●  
**21-123**  
∅8 mm



**21-124 - 126**  
200 mm

●  
**21-124**  
∅12 mm  
●  
**21-125**  
∅14 mm  
●  
**21-126**  
∅16 mm

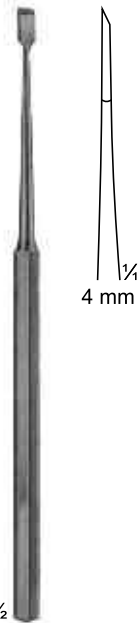

**21-127**  
FREER  
Chisel  
160 mm

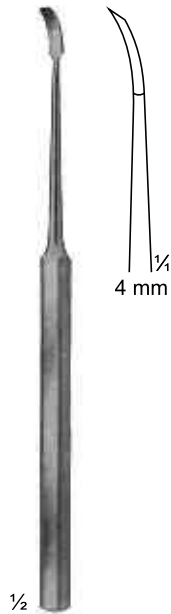

**21-128**  
FREER  
Chisel, curved  
160 mm

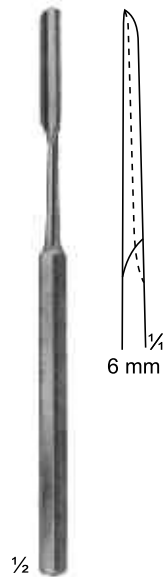

**21-129**  
FREER  
Gouge  
150 mm

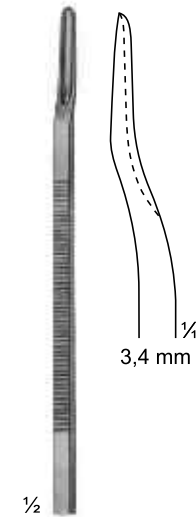

**21-130**  
Scaphoid gouge,  
downwards curved  
135 mm

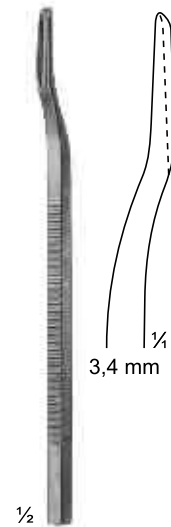

**21-131**  
Scaphoid gouge,  
upwards curved  
135 mm



**21-131A - 133**  
Mannerfelt  
**21-131A** 4 mm  
**21-132** 6 mm  
**21-133** 8 mm  
155 mm



# Osteotomes Chisels and Gouges

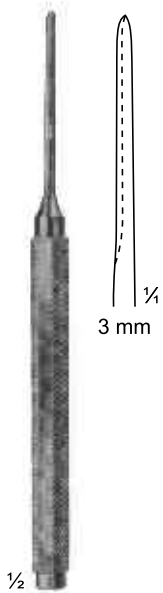

**21-134**  
Mannerfelt  
155 mm

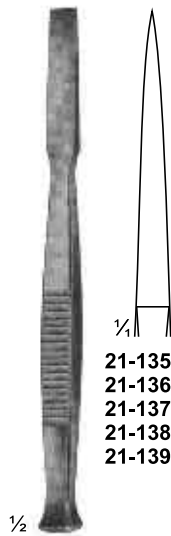

**21-135 - 139**  
Osteotome  
140 mm

- 21-135** 4 mm
- 21-136** 6 mm
- 21-137** 8 mm
- 21-138** 10 mm
- 21-139** 12 mm

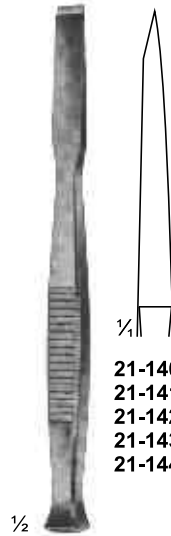

**21-140 - 144**  
Chisels  
140 mm

- 21-140** 4 mm
- 21-141** 6 mm
- 21-142** 8 mm
- 21-143** 10 mm
- 21-144** 12 mm

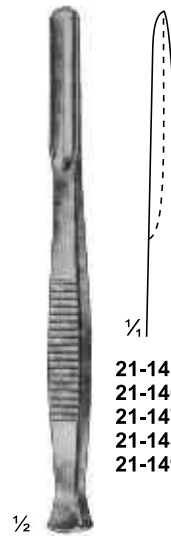

**21-145 - 149**  
Gouges  
140 mm

- 21-145** 4 mm
- 21-146** 6 mm
- 21-147** 8 mm
- 21-148** 10 mm
- 21-149** 12 mm

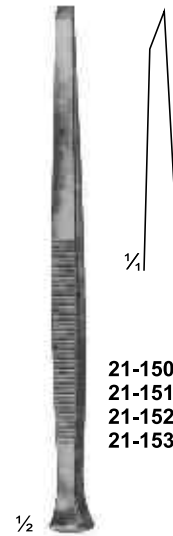

**PARTSCH**  
**21-150 - 153**  
Chisels  
140 mm

- 21-150** 3 mm
- 21-151** 4 mm
- 21-152** 5 mm
- 21-153** 6 mm

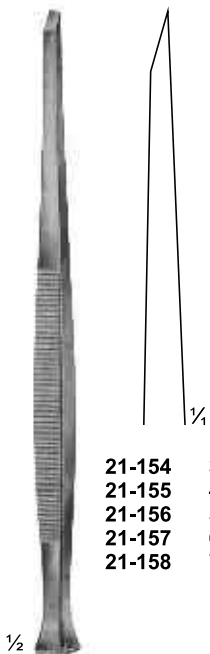

**PARTSCH**  
**21-154 - 158**  
Chisels  
170 mm

- 21-154** 3 mm
- 21-155** 4 mm
- 21-156** 5 mm
- 21-157** 6 mm
- 21-158** 7 mm

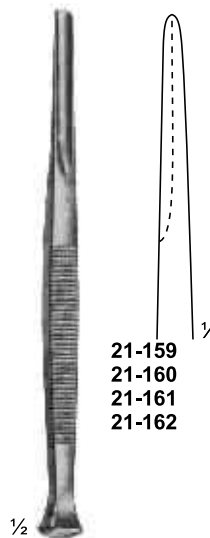

**PARTSCH**  
**21-159 - 162**  
Gouges  
140 mm

- 21-159** 3 mm
- 21-160** 4 mm
- 21-161** 5 mm
- 21-162** 6 mm

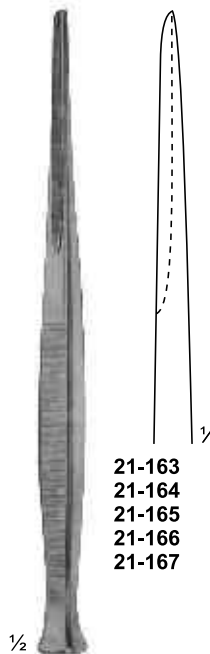

**PARTSCH**  
**21-163 - 167**  
Gouges  
170 mm

- 21-163** 3 mm
- 21-164** 4 mm
- 21-165** 5 mm
- 21-166** 6 mm
- 21-167** 7 mm



**LUCAS**  
**21-168 - 169**  
Chisels  
160 mm

- 21-168** 4 mm
- 21-169** 6 mm



**LUCAS**  
**21-170 - 171**  
Gouges  
160 mm

- 21-170** 3 mm
- 21-171** 5 mm

# Osteotomes Chisels and Gouges

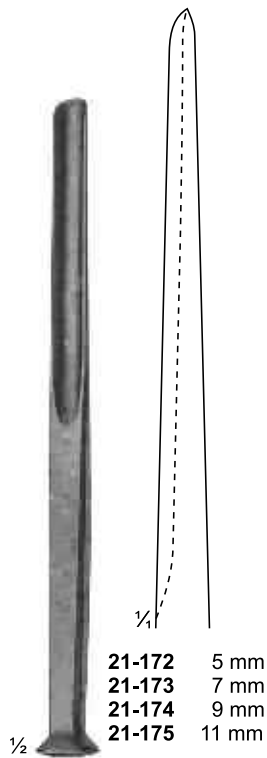

21-172 5 mm  
21-173 7 mm  
21-174 9 mm  
21-175 11 mm

**ALEXANDER**  
21-172 - 175  
Gouges  
170 mm

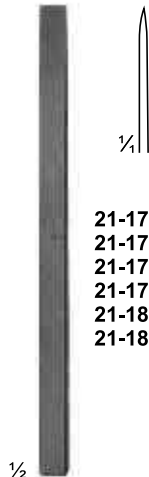

21-176 4 mm  
21-177 6 mm  
21-178 8 mm  
21-179 10 mm  
21-180 12 mm  
21-181 15 mm

**LAMBOTTE**  
21-176 - 181  
Osteotome  
125 mm

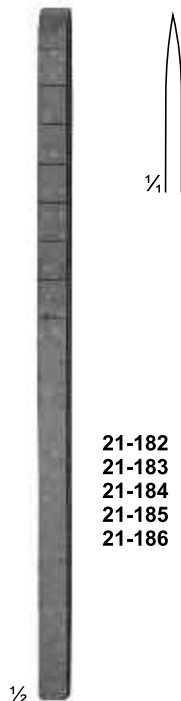

21-182 4 mm  
21-183 6 mm  
21-184 8 mm  
21-185 10 mm  
21-186 12 mm

**COTTLE**  
21-182 - 186  
Osteotome with depth  
markings  
180 mm

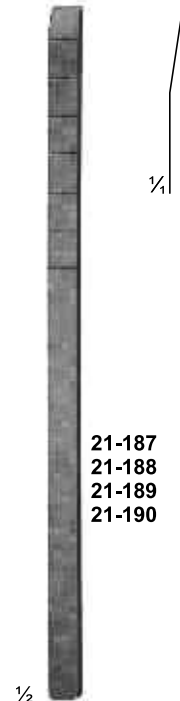

21-187 4 mm  
21-188 7 mm  
21-189 9 mm  
21-190 12 mm

**COTTLE**  
21-187 - 190  
Chisel-Osteotomes  
with depth markings  
180 mm



**COTTLE**  
21-191  
Fishtail Chisel,  
with protected ends  
180 mm

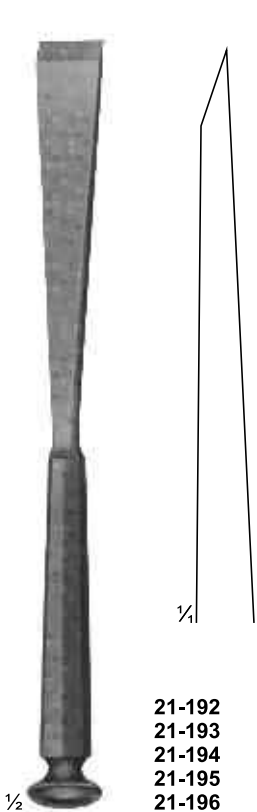

21-192 10 mm  
21-193 12 mm  
21-194 15 mm  
21-195 20 mm  
21-196 25 mm

**STILLE**  
21-192 - 196  
Chisels  
205 mm

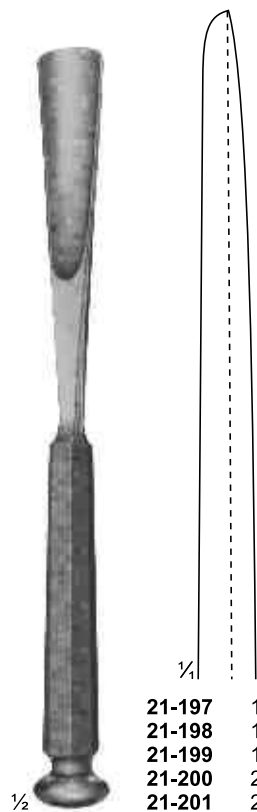

21-197 10 mm  
21-198 12 mm  
21-199 15 mm  
21-200 20 mm  
21-201 25 mm

**STILLE**  
21-197 - 201  
Gouges  
205 mm

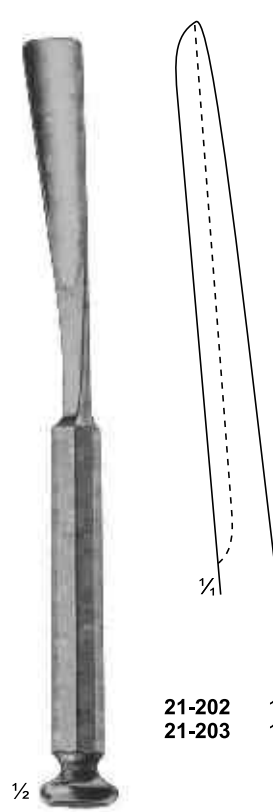

21-202 10 mm  
21-203 15 mm

**WALTER**  
21-202 - 203  
Osteotomes  
gouges for taking  
grafts from the rib  
205 mm

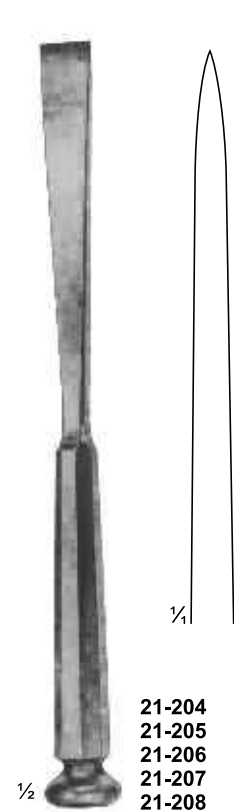

21-204 8 mm  
21-205 12 mm  
21-206 15 mm  
21-207 20 mm  
21-208 25 mm

**STILLE**  
21-204 - 208  
Osteotomes  
205 mm

# Osteotomes

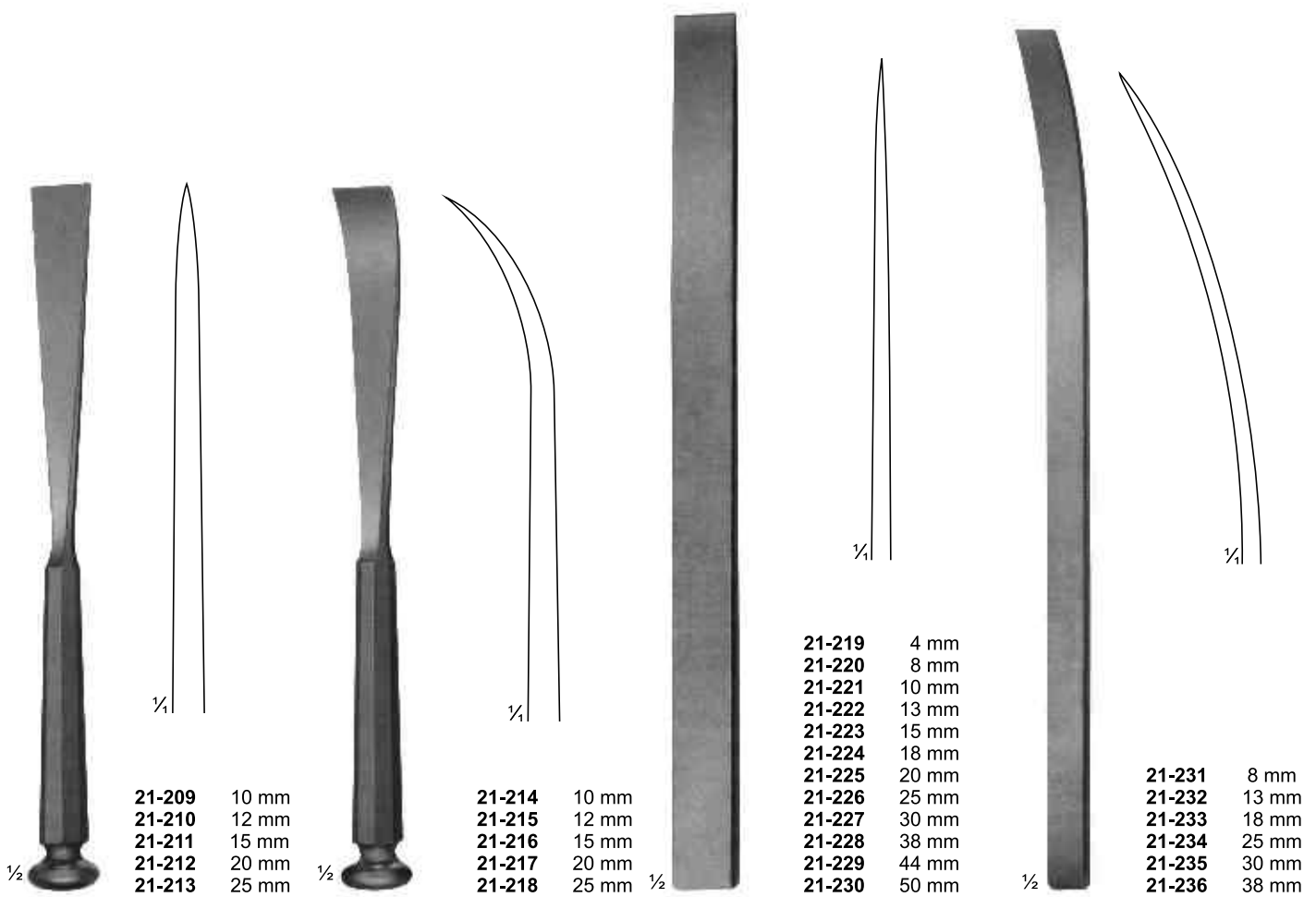











STILLE  
21-209 - 213  
Osteotomes  
205 mm

STILLE  
21-214 - 218  
Osteotomes, curved  
205 mm

LAMBOTTE  
21-219 - 230  
Osteotomes  
245 mm

LAMBOTTE  
21-231 - 236  
Osteotomes, curved  
245 mm

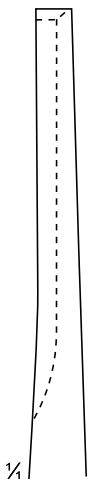
# Osteotomes, Chisels and Gouges with HARTPRESS -handle

  <p>1/4</p> <p>21-237 4 mm 21-238 6 mm 21-239 8 mm 21-240 10 mm 21-241 12 mm</p> <p>1/2</p>	  <p>1/4</p> <p>21-242 4 mm 21-243 6 mm 21-244 8 mm 21-245 10 mm 21-246 12 mm</p> <p>1/2</p>	  <p>1/4</p> <p>21-247 5 mm 21-248 7 mm 21-249 10 mm 21-250 15 mm 21-251 20 mm 21-252 25 mm 21-253 30 mm</p> <p>1/2</p>
<p>LEXER-MINI 21-237 - 241 Osteotomes 180 mm</p>   <p>1/4</p> <p>21-254 5 mm 21-255 7 mm 21-256 10 mm 21-257 15 mm 21-258 20 mm 21-259 25 mm 21-260 30 mm</p> <p>1/2</p> <p>LEXER 21-254 - 260 Gouges 220 mm</p>	<p>LEXER-MINI 21-242 - 246 Gouges 180 mm</p>   <p>1/4</p> <p>LEXER 21-247 - 253 Osteotomes 220 mm</p> <p>1/2</p> <p>LEXER 21-261 Gouge for removing broken screws 220 mm</p>	  <p>1/4</p> <p>21-262 5,5 mm 21-263 9,0 mm</p> <p>1/2</p> <p>ZIELKE 21-262 - 263 Gouge for scoliose-operations 230 mm</p>

# Osteotomes ,Chisels and Gouges with HARTPRESS -handle

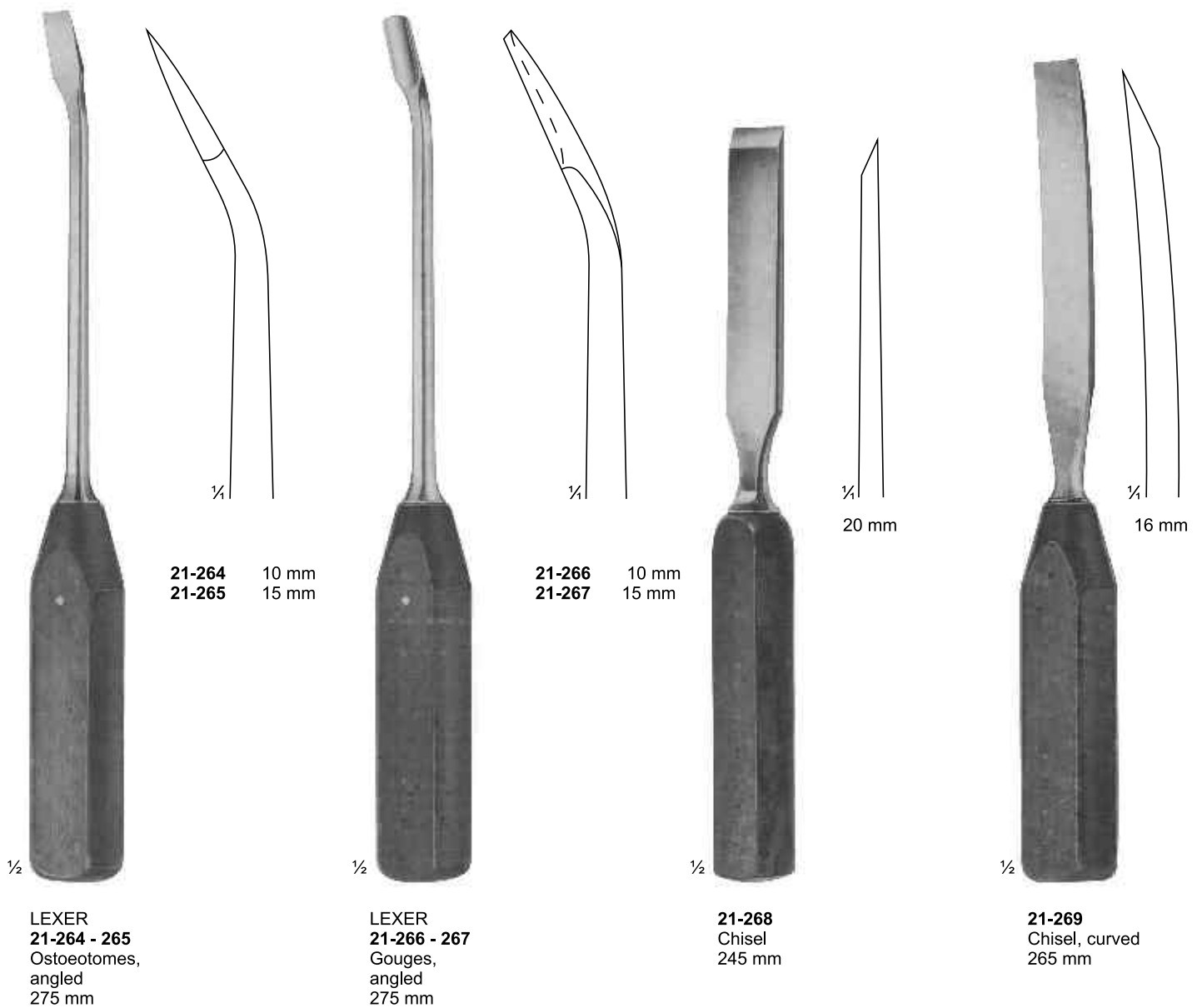

# Reposition Forceps

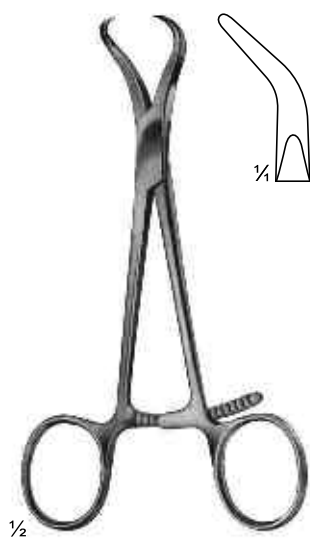

**22-101**  
Reposition forceps,  
for small fragments  
135 mm

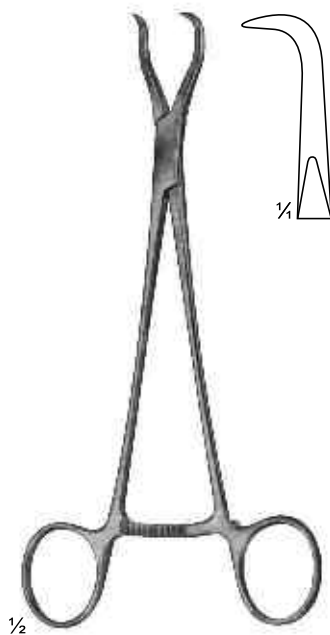

**HAASE**  
**22-102**  
Reposition forceps,  
for mandibular  
fractures  
165 mm

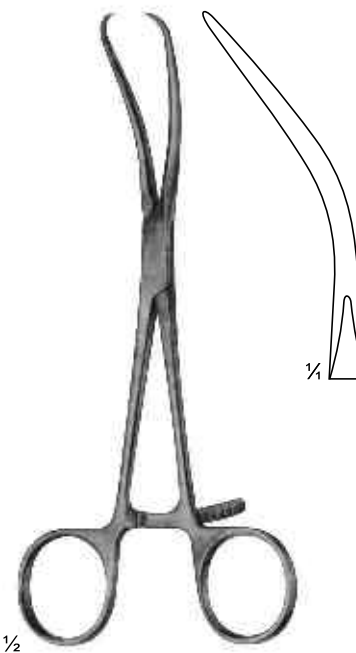

**REILL**  
**22-103**  
Reposition forceps,  
170 mm



**22-104**  
Reposition forceps  
205 mm

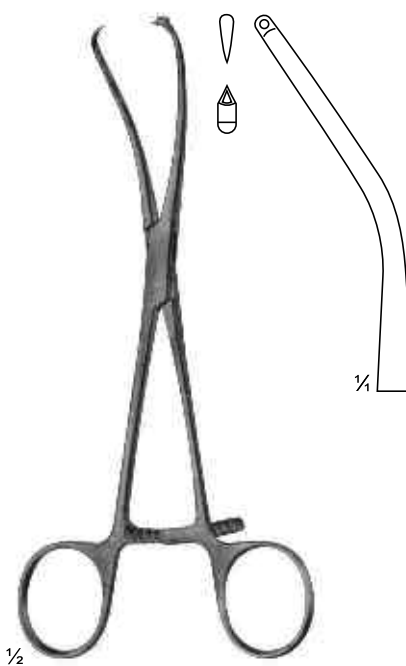

**MEYER**  
**22-105**  
Reposition forceps  
for fingers, with drill  
guide for KIRSCHNER  
wires up to diam. 1.0 mm  
170 mm

# Reposition Forceps, Bone Holding Forceps



**22-106**  
Patella forceps  
185 mm



**22-107**  
Forceps with  
ratchet fixation  
140 mm



**22-108**  
Forceps with  
thread fixation  
170 mm



**22-109**  
Forceps with  
thread fixation  
235 mm

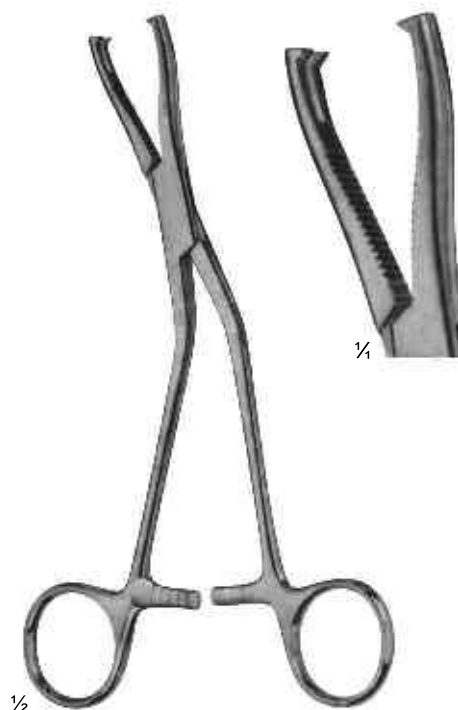

**22-110**  
DINGMANN  
185 mm

# Bone Holding Forceps



**22-111**  
Sequestrum  
forceps  
200 mm



**22-112**  
VAN BUREN  
Sequestrum  
forceps  
225 mm



**22-113**  
LANGENBECK  
Sequestrum  
forceps  
205 mm



**22-114**  
FERGUSON  
205 mm



# Bone Holding Forceps

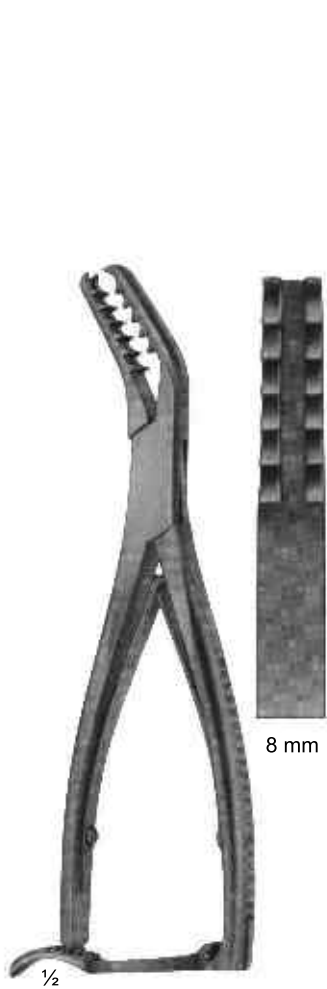
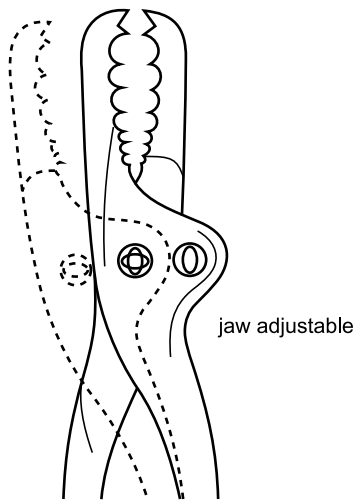

**22-115**  
SEMB  
190 mm



**22-116**  
FARABEUFF  
230 mm



**22-117**  
FARABEUFF  
255 mm



**22-118**  
FARABEUFF-LAMBOTTE  
255 mm

# Bone Holding Forceps



**22-119**  
KERN-LANE  
240 mm



**22-120**  
LANE  
330 mm



**22-121**  
KERN-LANE  
240 mm

# Bone Holding Forceps



**22-122**  
LANE  
320 mm

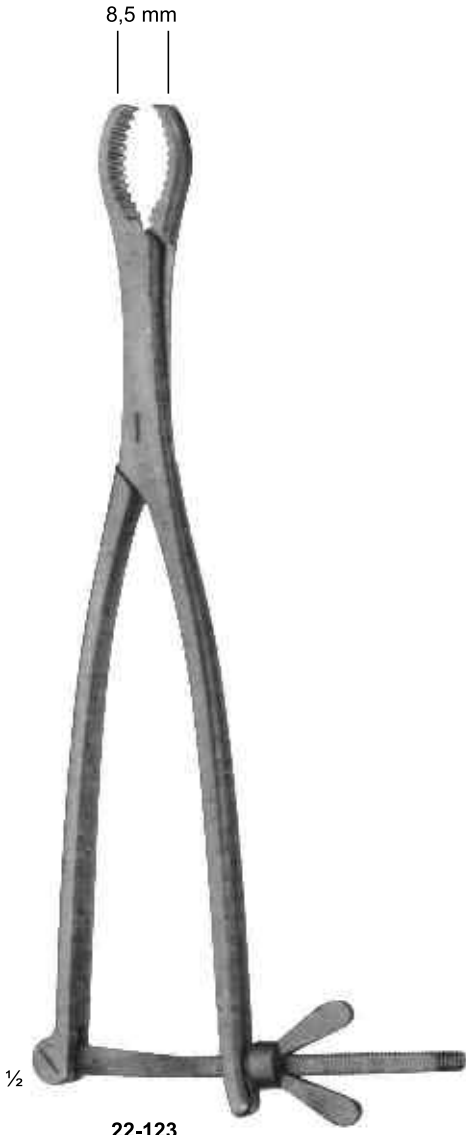

**22-123**  
HEY GROVES  
305 mm

# Bone Holding Forceps



**22-124 - 128**

- 22-124** 145 mm
- 22-125** 190 mm
- 22-126** 240 mm
- 22-127** 260 mm
- 22-128** 280 mm

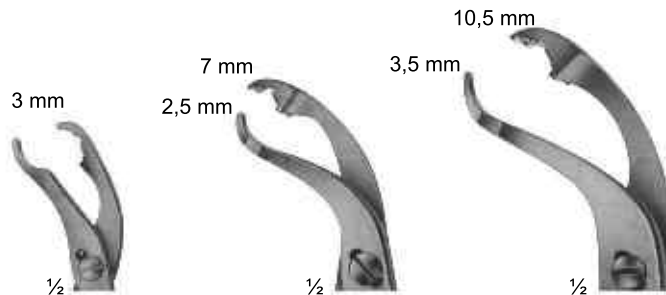

**22-124**  
for small  
fragments

**22-125**  
Fig: 0

**22-126**  
Fig: 1

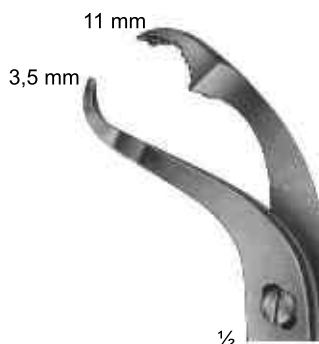

**22-127**  
Fig: 2

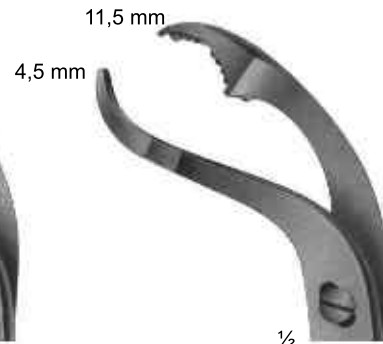

**22-128**  
Fig: 3

Self-centering forceps  
with thread fixation



**22-129 - 131**  
VERBRUGGE  
with lip joint

- 255 mm
- 265 mm
- 270 mm

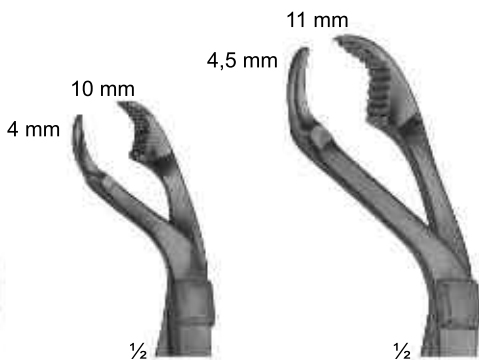

**22-129**  
Fig: 1

**22-130**  
Fig: 2

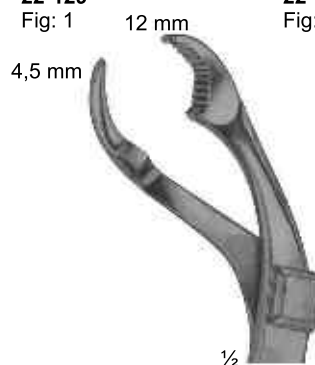

**22-131**  
Fig: 3



**22-132**  
LAMBOTTE  
265 mm

## Bone Clamps

---



½  
**22-133 - 134**  
LOWMAN  
**22-133** 170 mm  
**22-134** 205 mm



½  
**22-135**  
LOWMAN-GERSTER  
210 mm



½  
**22-136**  
LOWMAN-HOGLUND  
175 mm

# Synovectomy-Rongeurs, Bone Rongeurs



**22-137 - 138**  
Synovcetomy rongeur  
width of jaws 1.2 mm  
130 mm

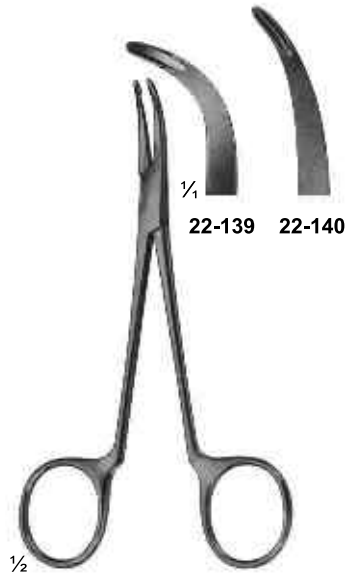

**22-139 - 140**  
Synovcetomy rongeur  
width of jaws 2.0 mm  
130 mm



**22-141**  
STELLBRINK  
Synovcetomy rongeur  
175 mm

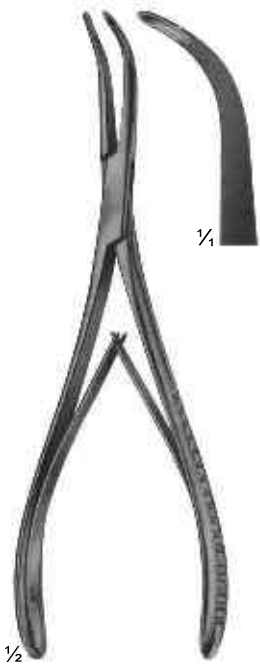

**22-142**  
STELLBRINK  
Synovcetomy rongeur  
170 mm



**22-143**  
LURE-FRIEDMANN  
145 mm

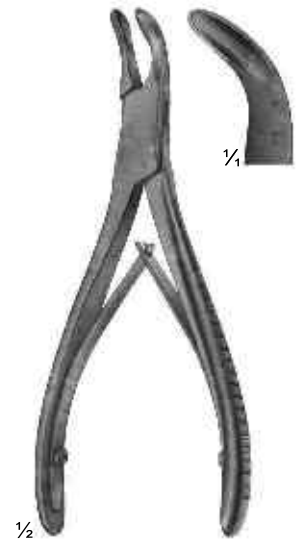

**22-144**  
140 mm

# Bone Rongeurs



**22-145**  
LURE  
150 mm

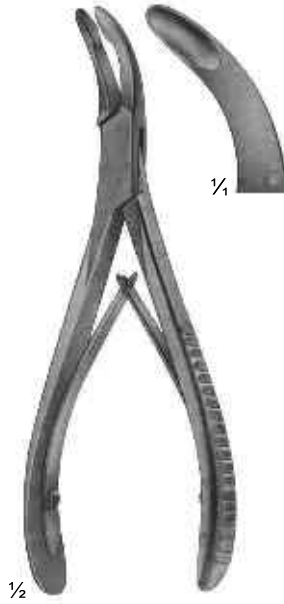

**22-146**  
LURE  
155 mm

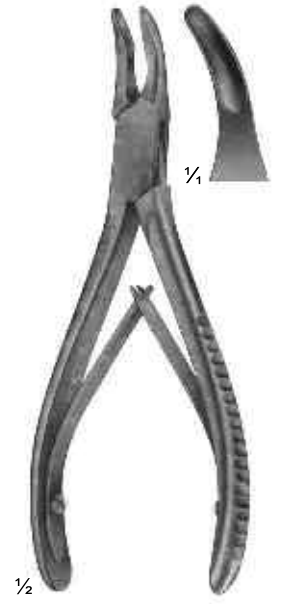

**22-147**  
BLUMENTHAL  
155 mm

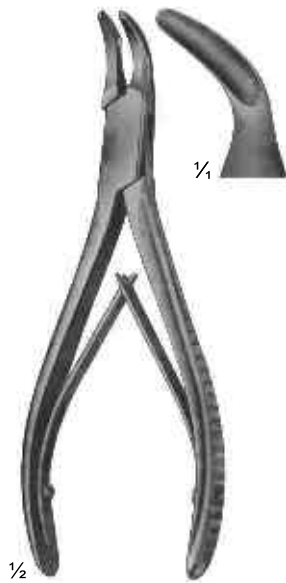

**22-148**  
BLUMENTHAL  
150 mm

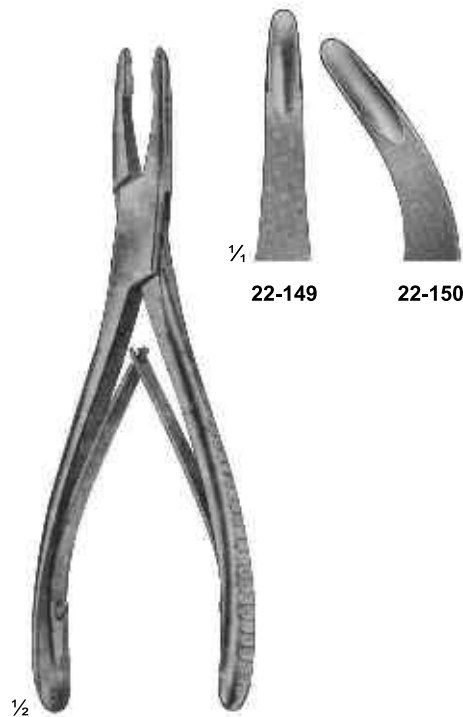

**22-149 - 150**  
JANSEN  
175 mm

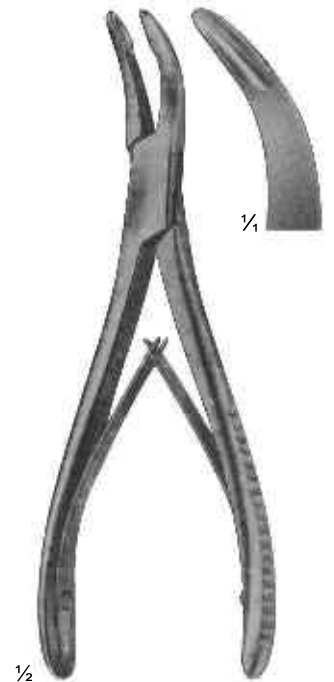

**22-151**  
BANE-HARTMANN  
175 mm

# Bone Rongeurs



**22-152**  
ALEXANDER  
140 mm

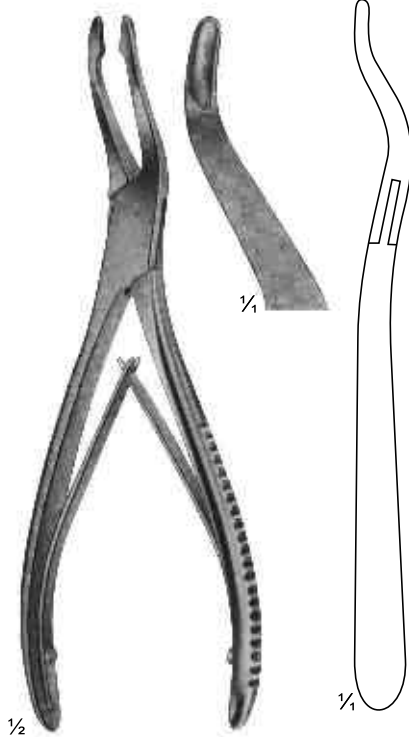

**22-153**  
JANSEN  
190 mm

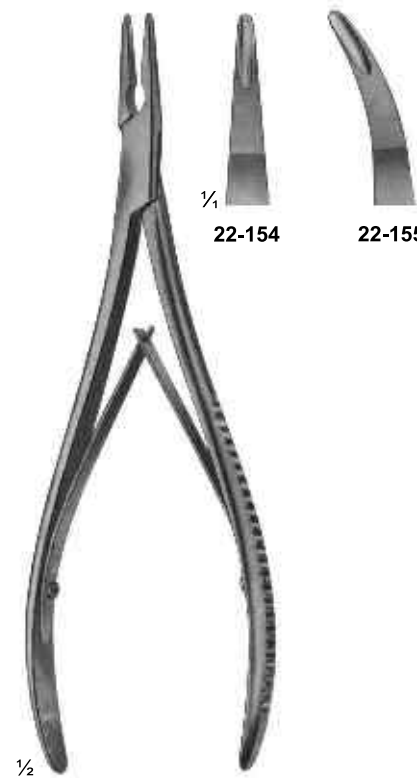

**22-154 - 155**  
LEMPERT  
200 mm

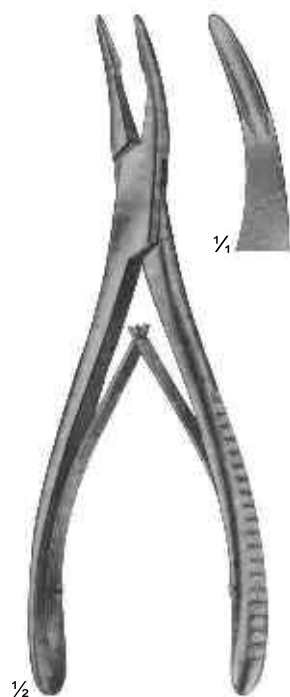

**22-156**  
BEYER  
180 mm

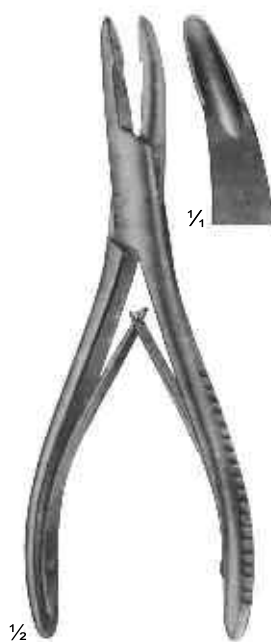

**22-157**  
MEAD  
165 mm

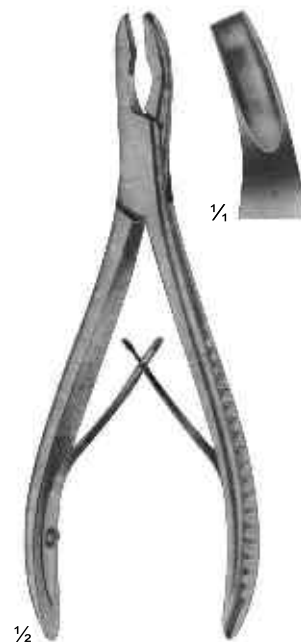

**22-158**  
MEAD  
165 mm



# Bone Rongeurs

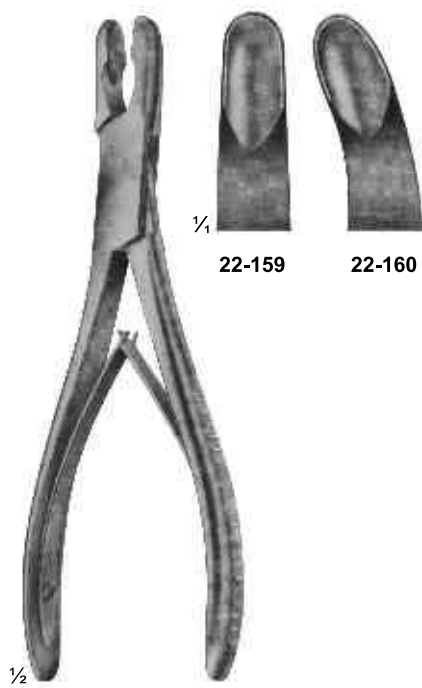

22-159 22-160

22-159 - 160  
LURE  
175 mm

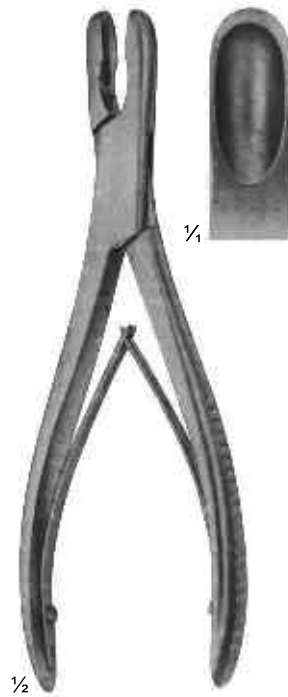

22-161  
LURE  
180 mm

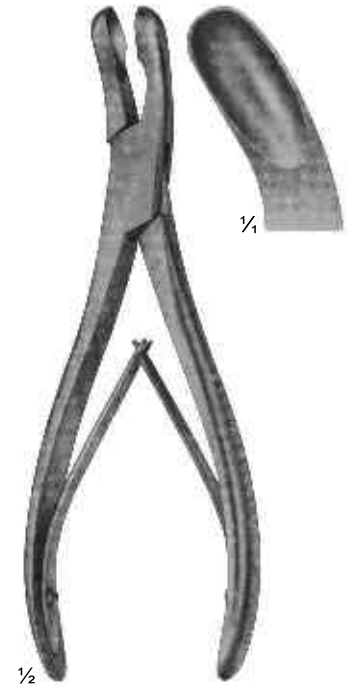

22-162  
LURE  
180 mm

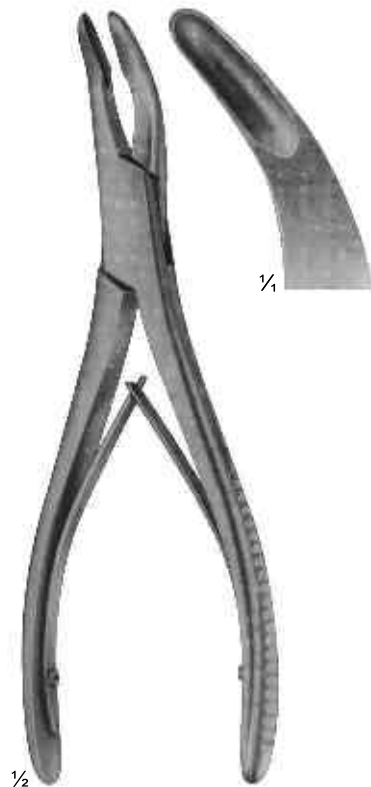

22-163  
OLIVECRONA  
205 mm



22-164 - 165  
BOHLER  
155 mm

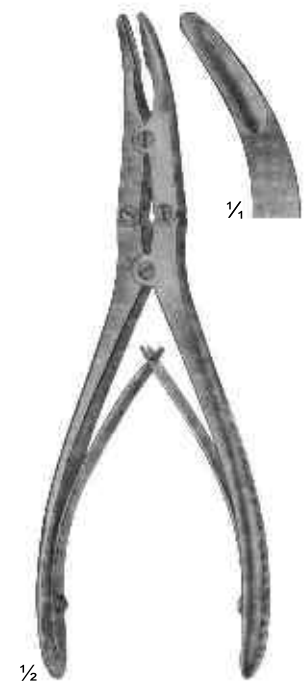

22-166  
MARQUARTD  
200 mm

# Bone Rongeurs

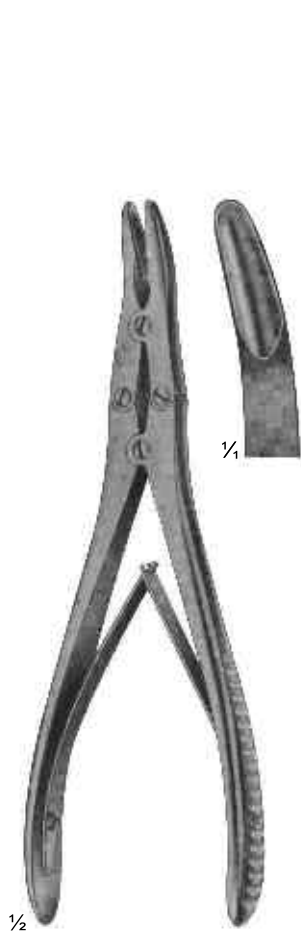

**22-167**  
RUSKIN  
190 mm



**22-168**  
ROTTGEN-RUSKIN  
240 mm

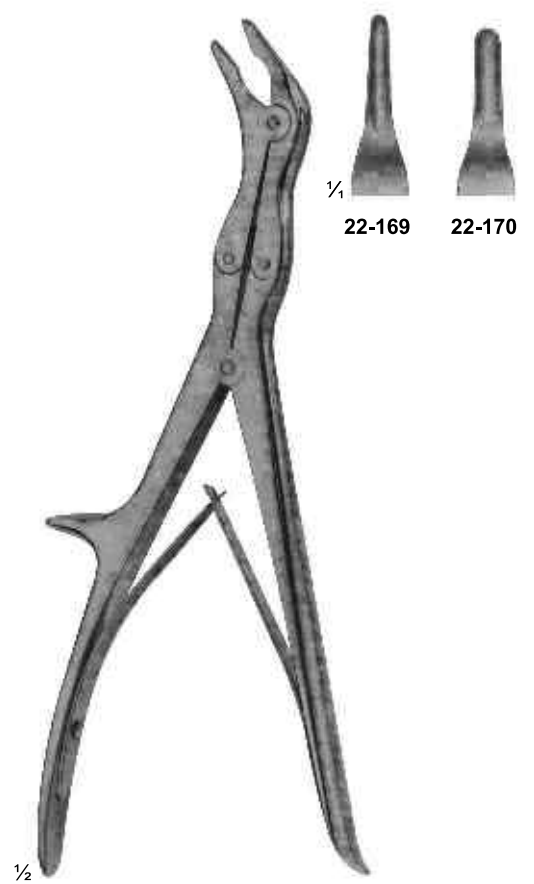

**22-169 - 170**  
ECHLIN  
230 mm

# Bone Rongeurs



**22-171**  
STILLE  
235 mm



**22-172**  
LEKSELL-STILLE  
240mm



**22-173**  
STILLE-RUSKIN  
240mm

# Bone Rongeurs



**22-174**  
LURE-STILLE  
225 mm



**22-175**  
LURE-STILLE  
225 mm

# Vena-Cava Clamps



**17-233 - 235**  
DE BAKEY  
205 mm, 225 mm, 240 mm



$\frac{1}{4}$   
**17-233** 41 mm  
**17-234** 65 mm  
**17-235** 80 mm



**17-236 - 238**  
DE BAKEY  
200 mm, 225 mm, 240 mm



$\frac{1}{4}$   
**17-236** 41 mm  
**17-237** 65 mm  
**17-238** 80 mm

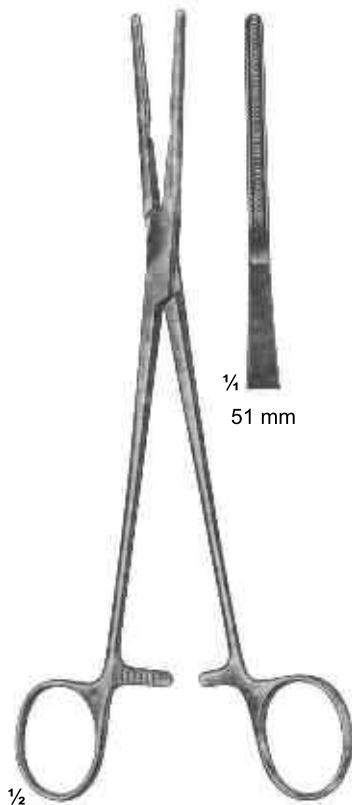

**17-239**  
DE BAKEY  
210 mm



$\frac{1}{4}$   
51 mm



**17-240**  
DE BAKEY  
210 mm

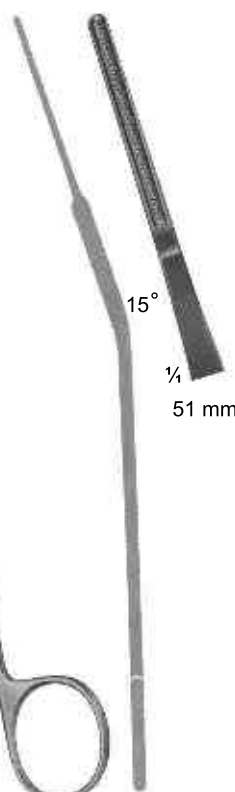

15°  
 $\frac{1}{4}$   
51 mm

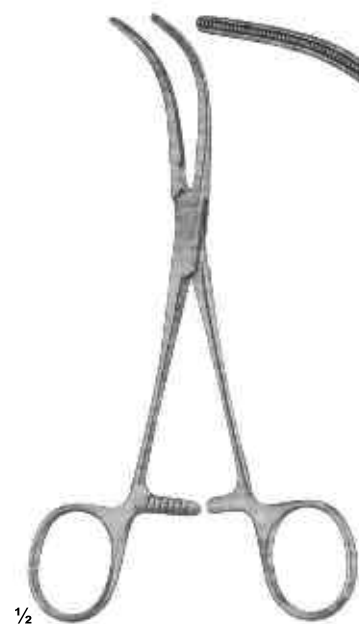

**17-241**  
DE BAKEY  
160 mm

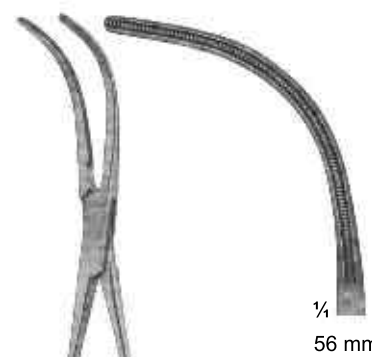

$\frac{1}{4}$   
56 mm

# Bone Cutting Forceps

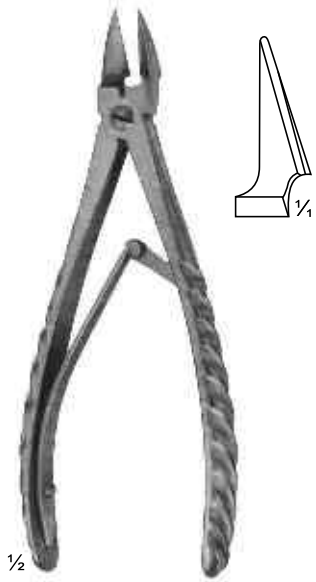

**22-178**  
STAMM  
150 mm

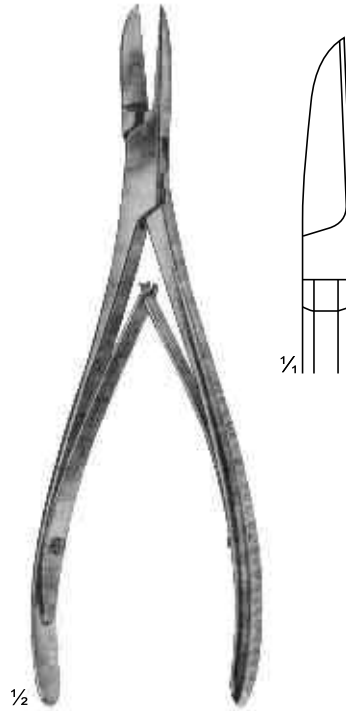

**22-179**  
KAZANJIAN  
185 mm

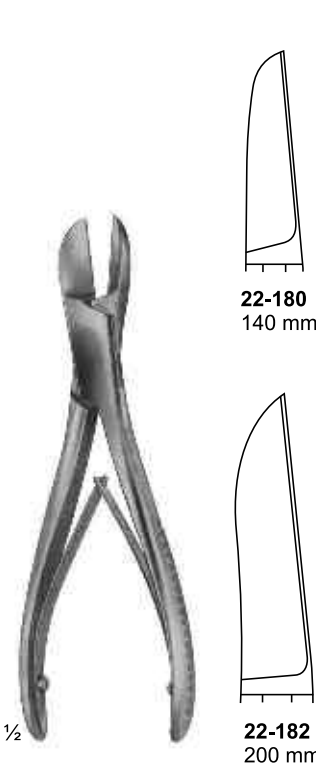

**22-180 - 183**  
LISTON

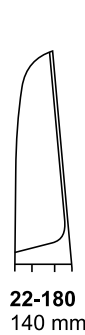

**22-180**  
140 mm

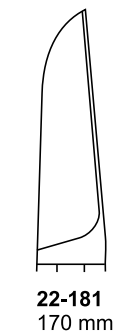

**22-181**  
170 mm



**22-182**  
200 mm

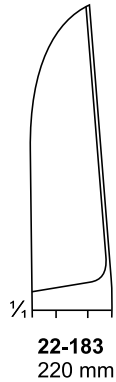

**22-183**  
220 mm

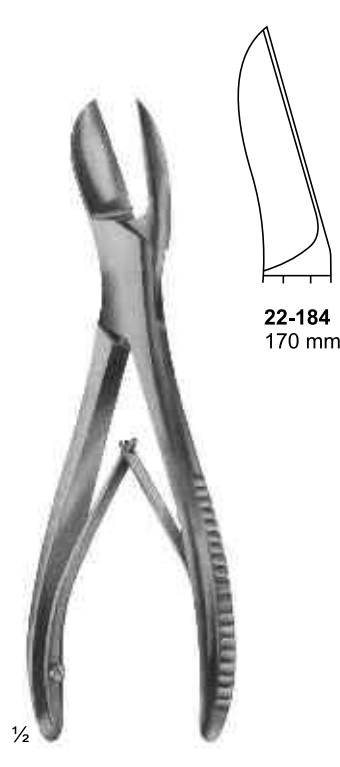

**22-184 - 186**  
LISTON



**22-184**  
170 mm

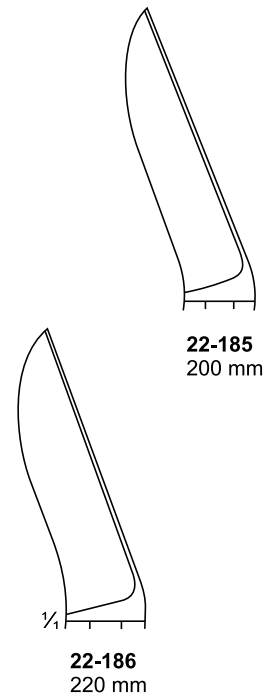

**22-185**  
200 mm

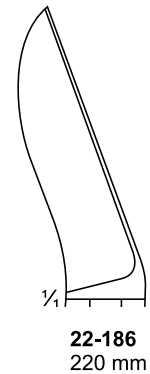

**22-186**  
220 mm

# Bone Cutting Forceps

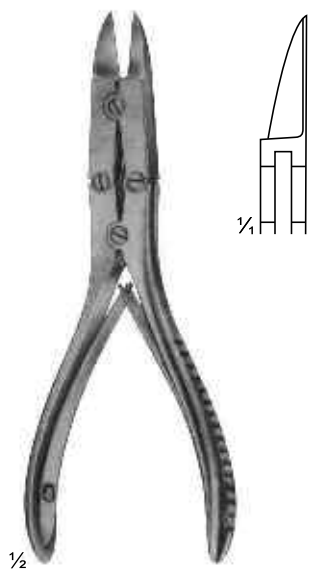

**22-187**  
BOHLER  
145 mm

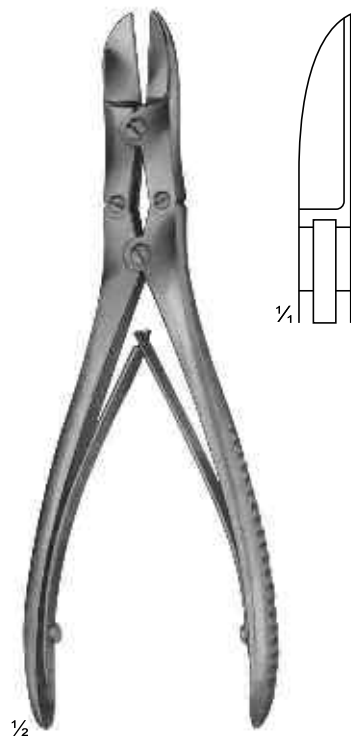

**22-188**  
RUSKIN-LISTON  
190 mm

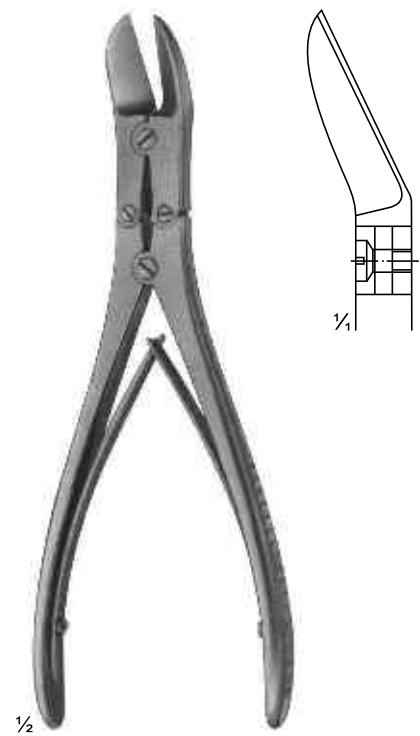

**22-189**  
RUSKIN-LISTON  
190 mm

# Bone Cutting Forceps

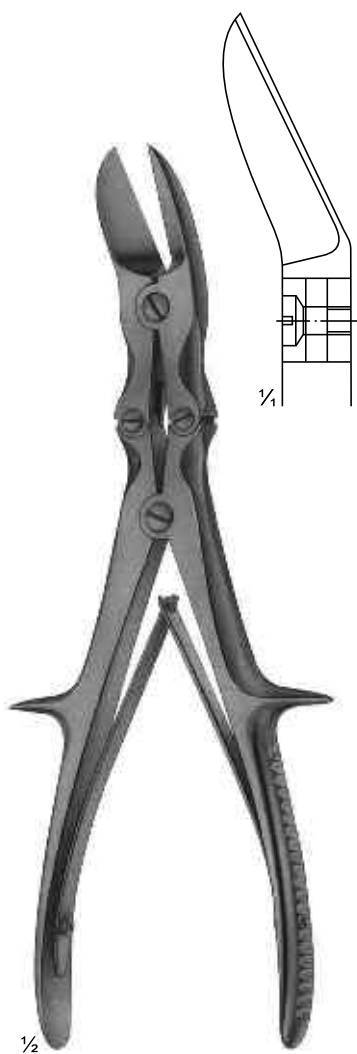

**22-190**  
LISTON  
curved on flat  
240 mm

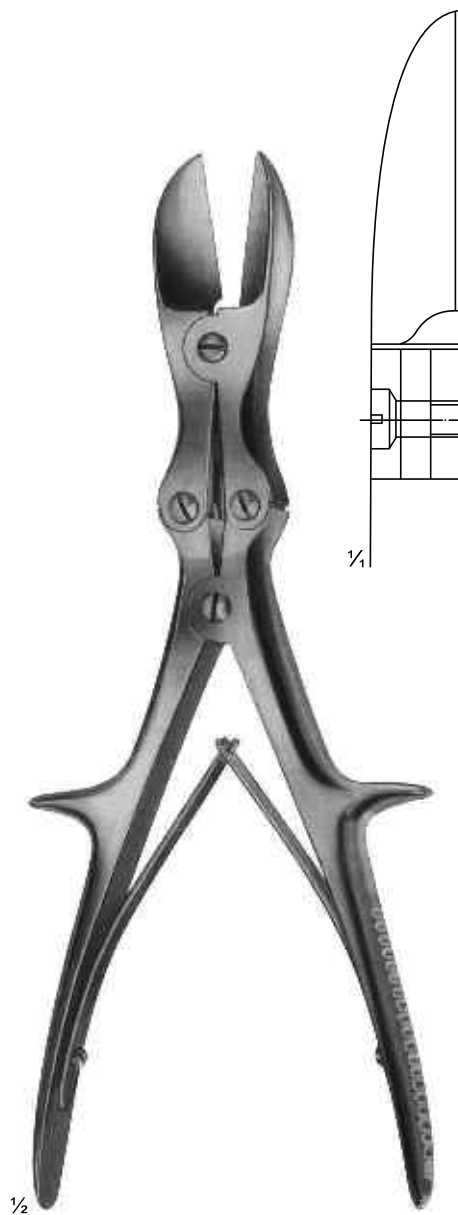

**22-191**  
LISTON  
straight  
280 mm

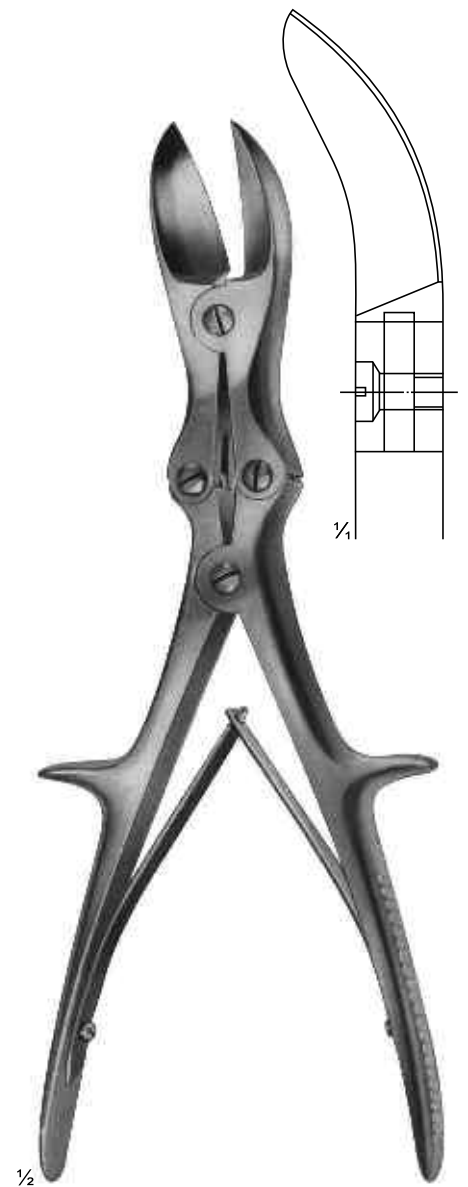

**22-192**  
LISTON  
curved on flat  
280 mm



# Bone Cutting Forceps

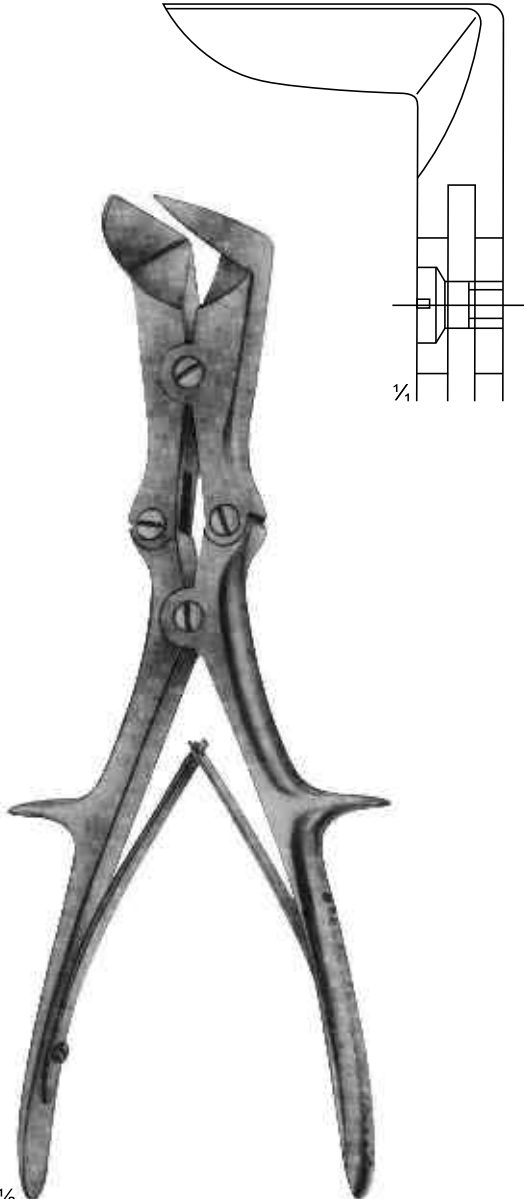

**22-193**  
LISTON-STILLE  
265 mm

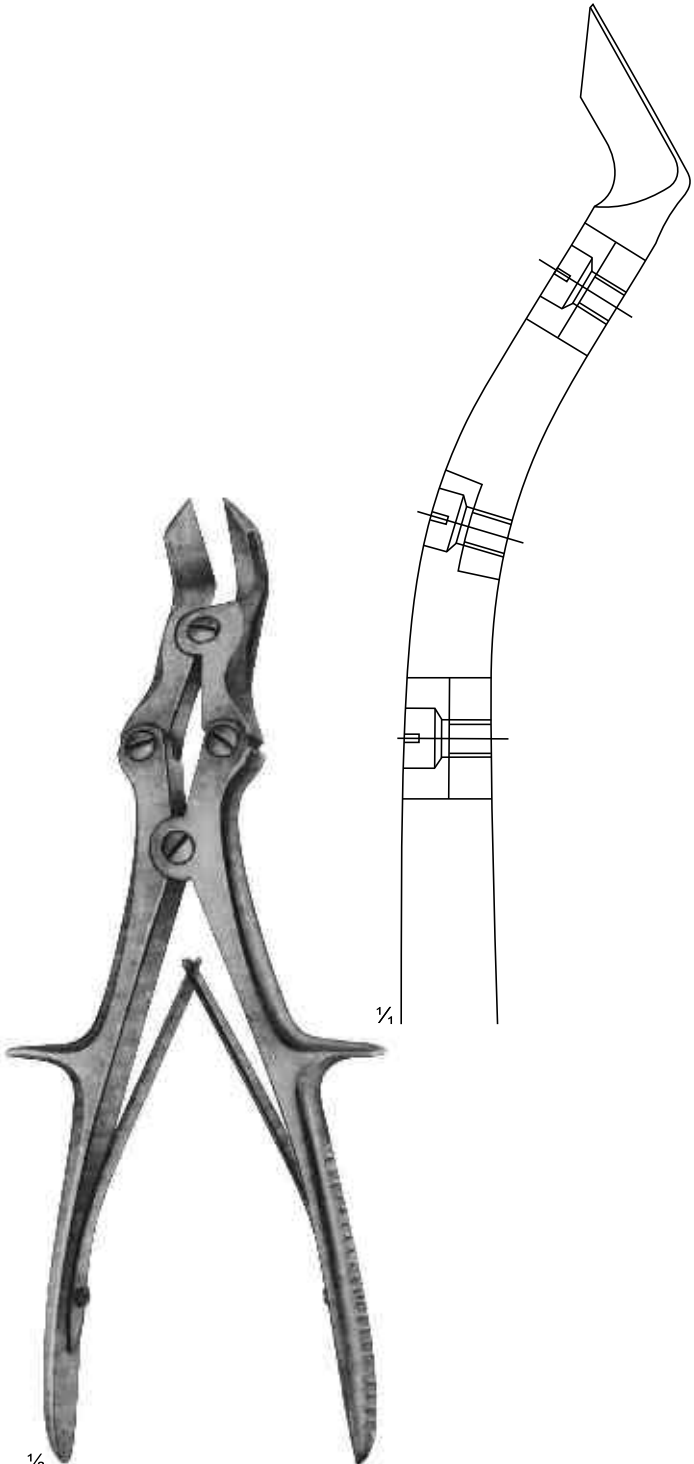

**22-194**  
LISTON-KEY-HORSLEY  
(TUDOR EDWARDS)  
255 mm

# Meniscus-and Cartilage Forceps



**22-195**  
BIRCHER  
200 mm



**22-196**  
BIRCHER  
200 mm

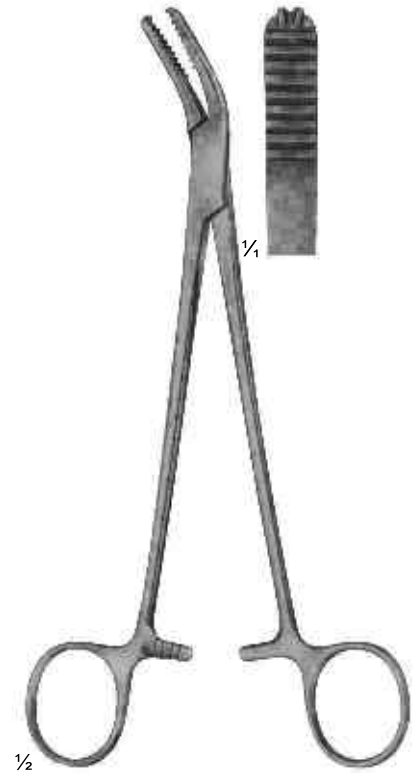

**22-197**  
WELLER  
200 mm

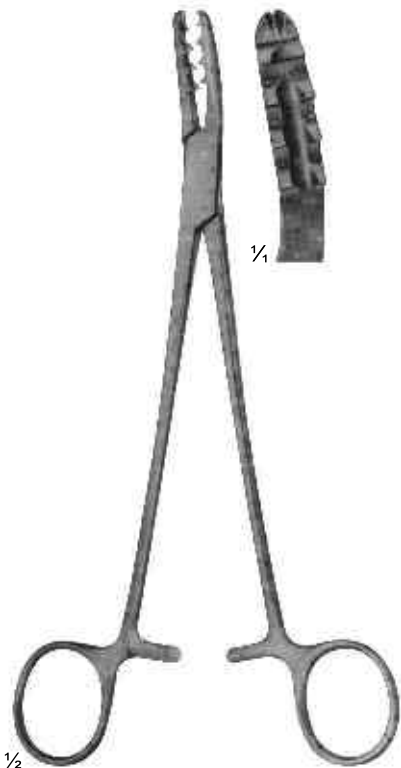

**22-198**  
BIRCHER-GANSKE  
200 mm

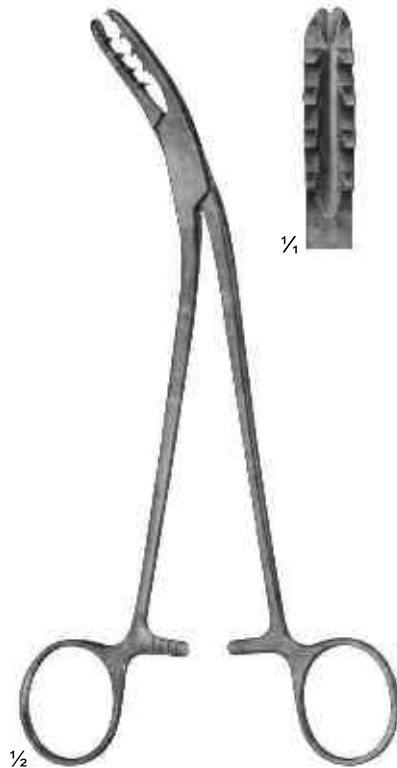

**22-199**  
BIRCHER-GANSKE  
200 mm



**22-200**  
MARTIN  
205 mm

# Meniscus Knives

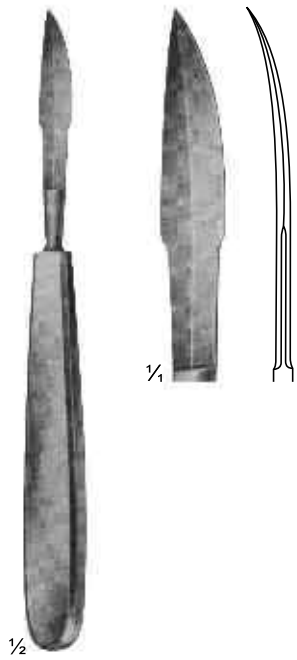

**22-201**  
170 mm

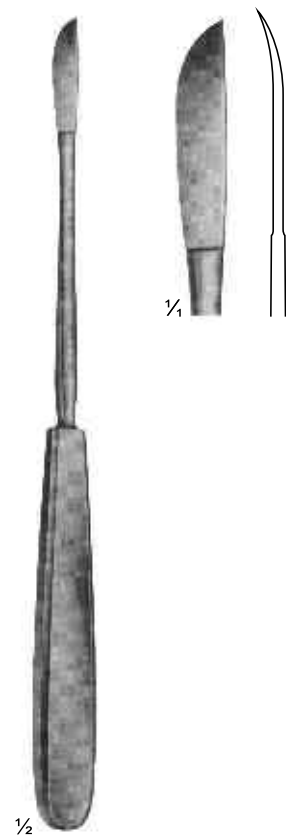

**22-202**  
NEFF  
215 mm

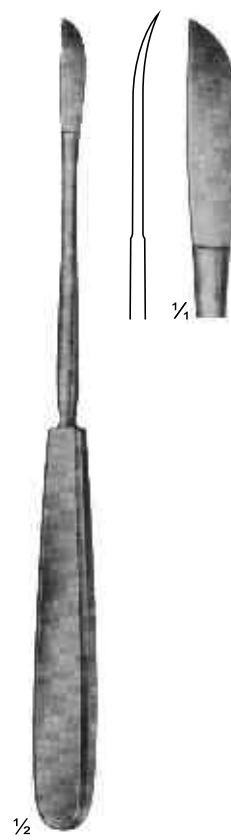

**22-203**  
NEFF  
215 mm

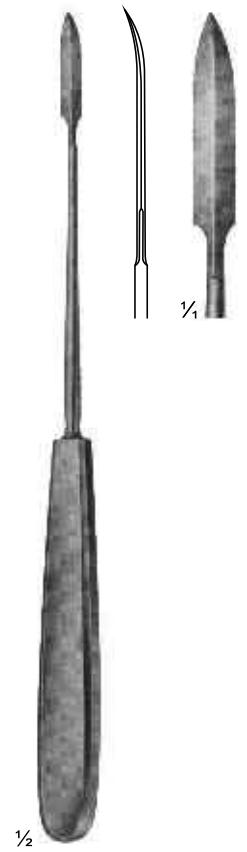

**22-204**  
WAGNER  
215 mm

# Meniscus Knives

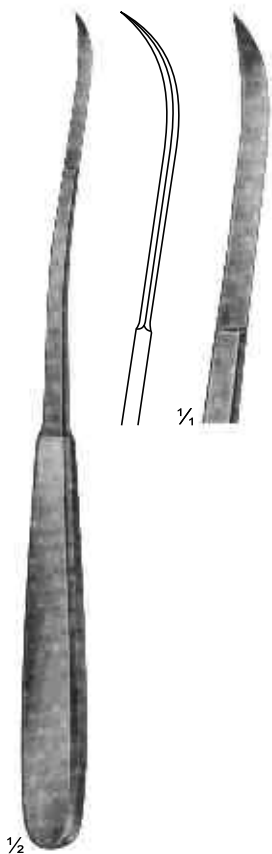

**22-205**  
SALENIUS  
220 mm

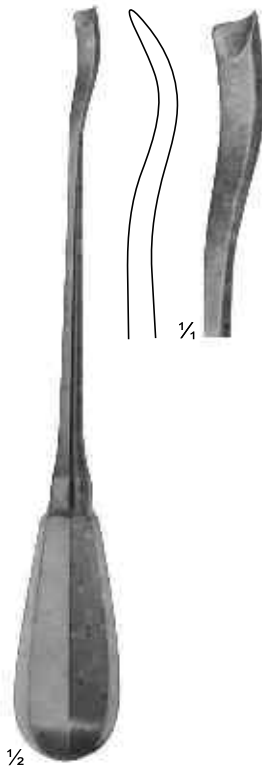

**22-206**  
CHNAD.MODELL  
200 mm

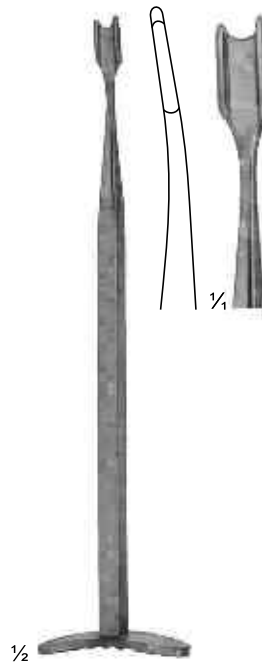

**22-207**  
SMILLIE  
170 mm

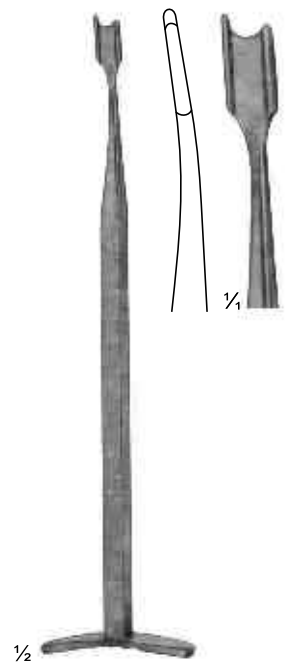

**22-208**  
SMILLIE  
170 mm

# Wire Extension

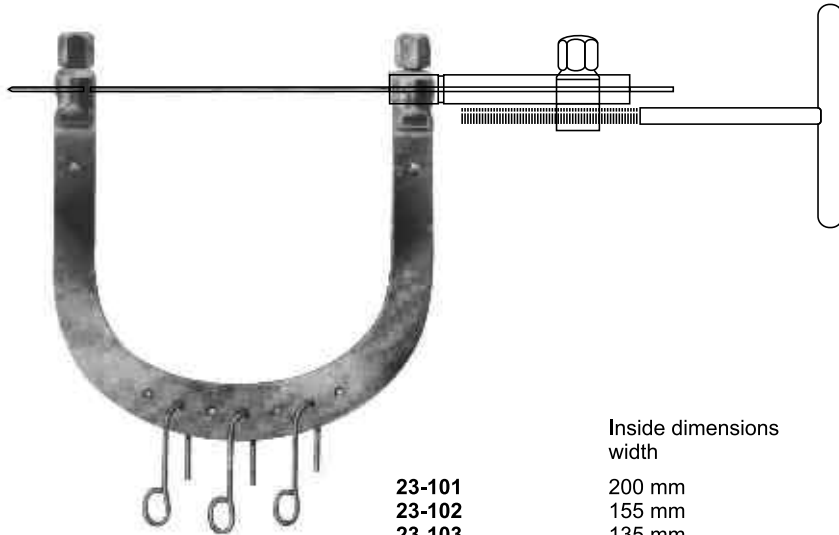

**23-101 - 107**  
KIRSCHNER  
Wire traction bows,  
to be used with  
KIRSCHNER-wires  
up to 2.5 mm diam.,  
With 3 hooks,  
stainless steel

- 23-101**
- 23-102**
- 23-103**
- 23-104**
- 23-105**
- 23-106**
- 23-107**

Inside dimensions	width	depth
<b>23-101</b>	200 mm	155 mm
<b>23-102</b>	155 mm	155 mm
<b>23-103</b>	135 mm	130 mm
<b>23-104</b>	120 mm	120 mm
<b>23-105</b>	105 mm	100 mm
<b>23-106</b>	95 mm	110 mm
<b>23-107</b>	95 mm	70 mm



**23-108**  
Wrench, double - ended,  
for wire traction bows



**23-109**  
Wire tightener, with  
clamping jaws



1/3

**23-110**  
Traction hook only,  
large size



1/3

**23-111**  
Traction hook only,  
small size



1/3

**23-112**  
Fixation clamp, to secure clamping  
jaws of stainless steel

# Wire Extension

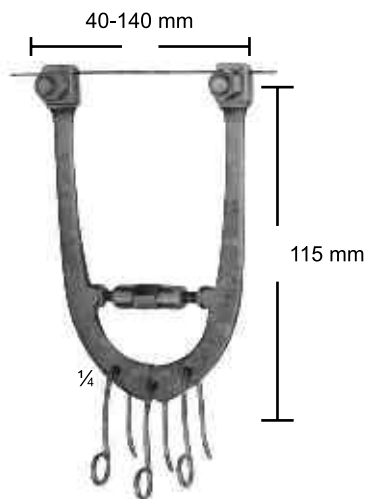

**23-113**  
Wire traction bow, adjustable,  
with 3 hooks, small size

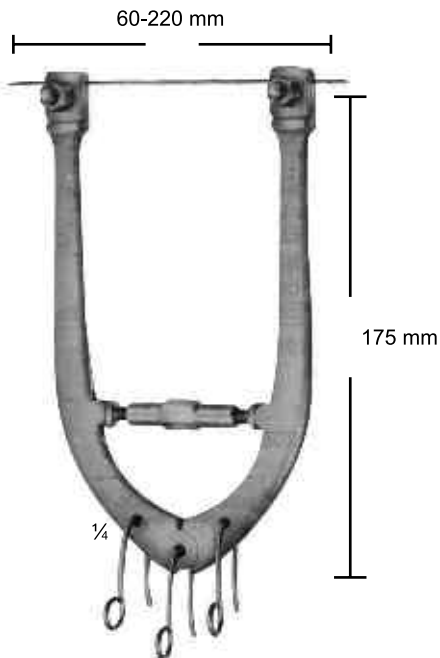

**23-114**  
Wire traction bow, adjustable,  
with 3 hooks, large size

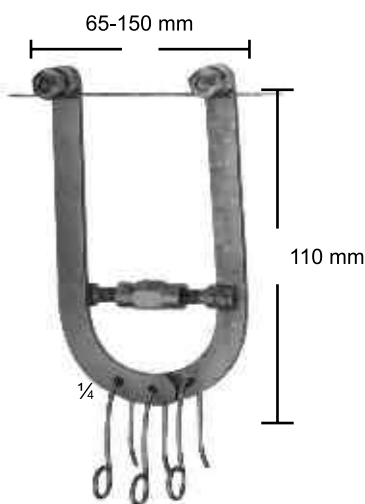

**23-115**  
Wire traction bow, adjustable,  
with 3 hooks, large size for  
elbow and calcaneus, for  
adolescents



**23-116 - 118**  
**KIRSCHNER**  
Wire traction bow, modified  
adjustable in with width, holds wire  
securely, with 1 hook

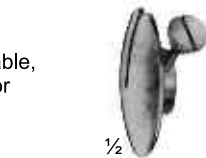

**23-119**  
Fixation disc, slotted



**23-120**  
idem, aluminum, transparent  
to X-rays



**23-121**  
Fixation disc, slotted



**23-122**  
Screw driver, for above  
fixations discs

# Traction Bows, Distractor

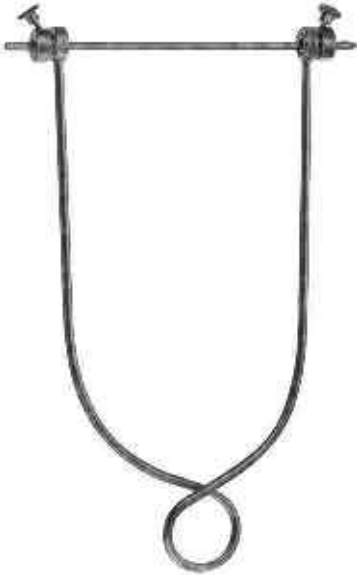

**23-123 - 130**  
Screw driver, for above  
fixations discs

Steinmann pins, 4 mm daim.	Steinmann pins, 5 mm daim.
<b>23-123</b> with pin	16x9cm Arm
<b>23-124</b> without pin	<b>23-129</b> without
<b>23-125</b> with pin	21x11cm Arm
<b>23-126</b> without pin	<b>23-130</b> without
<b>23-127</b> with pin	21x15cm Arm
<b>23-128</b> without pin	



**23-131**  
**SCHWARZ**  
Traction bow for fingers,  
to be used with KIRSCHNER-  
wire up to 1.6 mm diam.

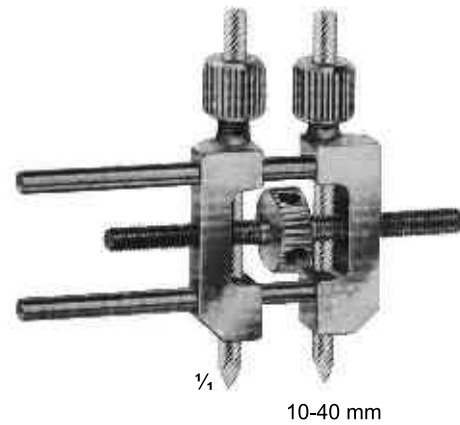

**23-132**  
Small distractor  
as a repositioning device for  
distraction and compression of small bones,  
for wires with 3.0 mm diam.

# STEINMANN Pins



## 23-133 - 147

STEINMANN

triangular shaft ended and trocar point

Length	4,0 mm	5,0 mm
80 mm	<b>23-133</b>	
100 mm	<b>23-134</b>	
120 mm	<b>23-135</b>	
140 mm	<b>23-136</b>	
150 mm	<b>23-137</b>	<b>23-143</b>
160 mm	<b>23-138</b>	
180 mm	<b>23-139</b>	<b>23-144</b>
200 mm	<b>23-140</b>	<b>23-145</b>
210 mm	<b>23-141</b>	
250 mm	<b>23-142</b>	<b>23-146</b>
300 mm		<b>23-147</b>



1/4

### 23-148

Protection cap  
for 4,0 mm STEINMANN Pins



1/4

### 23-149

Protection cap  
for 5,0 mm STEINMANN Pins



# Drilling Chucks



1/2

**23-150**  
REILL  
Drilling chuck, cannulated, for shanks from 2.0 - 2.5 mm diam 115 mm



1/2

**23-151**  
Drilling chuck, cannulated, for shanks from 0.8 - 2.0 mm diam 150 mm



1/2

**23-152**  
Drilling chuck, cannulated, for shanks up to 4.5 mm diam with key 140 mm



1/2

**23-153**  
LOUTE  
Wire tightener, improved pattern, with movable tip, for wires up to 1.0 mm diam. 220 mm

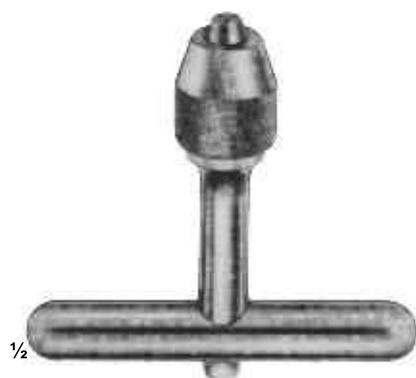

1/2

**23-154**  
Drilling chuck, cannulated, for shanks up to 6.35 mm diam., To be tightened by hand 100 mm

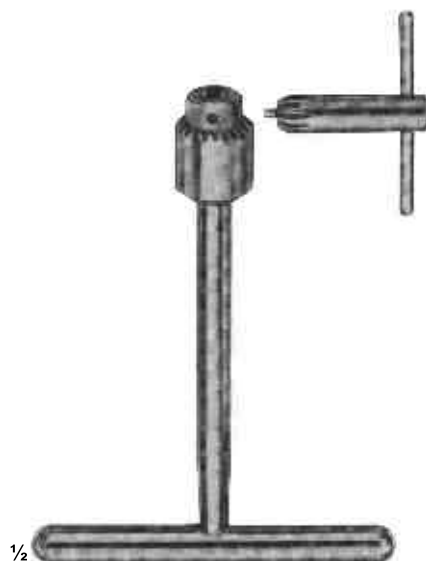

1/2

**23-155**  
Drilling chuck, cannulated, for shanks up to 4.5 mm diam., And for triangular shaft width across flats 4.7 mm

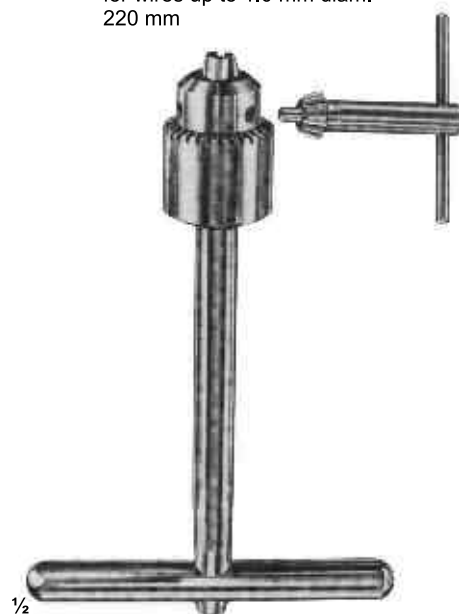

1/2

**23-156**  
Drilling chuck, cannulated, for shanks up to 6.35 mm diam., With key 160 mm

# Cerclage Instruments

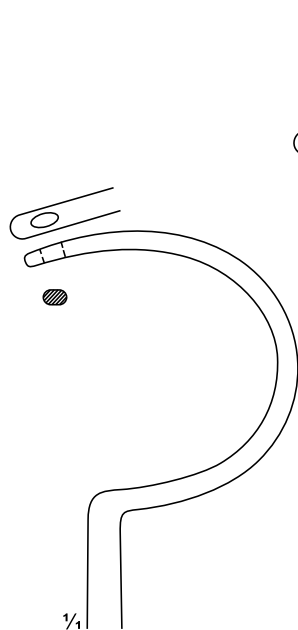

**23-157**  
275 mm

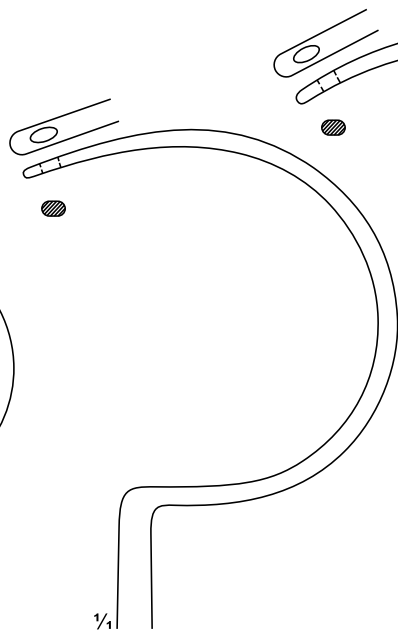

**23-158**  
285 mm

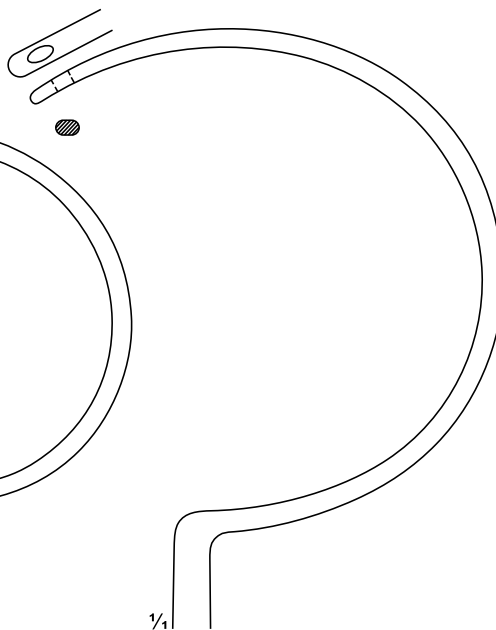

**23-159**  
305 mm



**23-157 - 159**  
DEMEL  
Wire guides

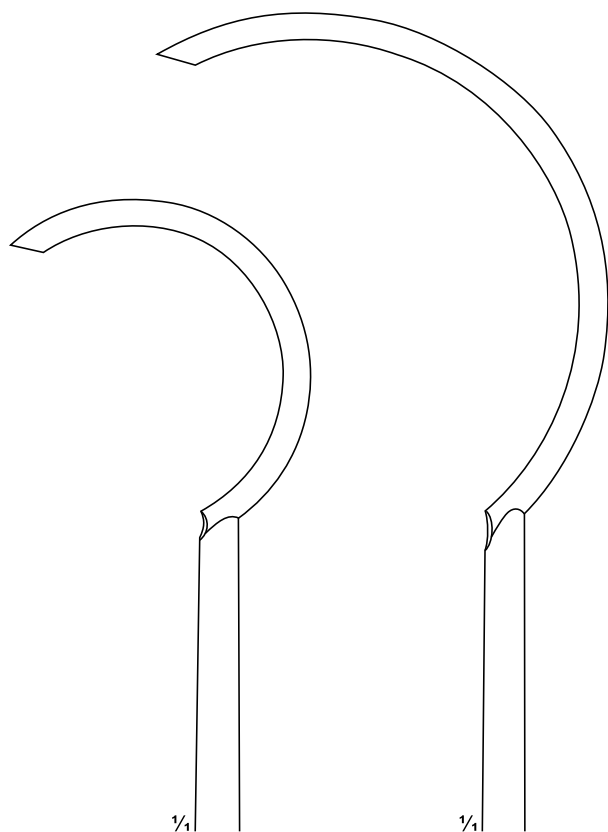

**23-160**  
240 mm

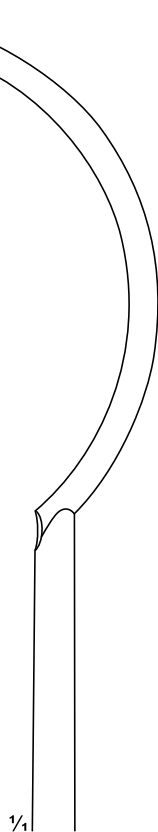

**23-161**  
270 mm

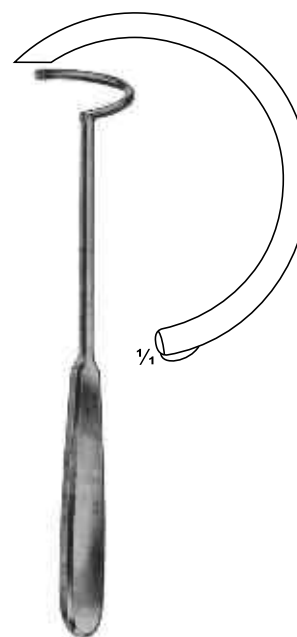

**23-162**  
225 mm

## JORDAN instruments for subcutaneous Tibia Cerclage



**23-163**  
JORDAN  
Wire tightener



1/2

**23-164**  
JORDAN  
Wire twister  
170 mm



1/2

**23-165**  
JORDAN  
Wire catcher  
180 mm



1/2

**23-166**  
JORDAN  
Probe, cannulated  
170 mm

# Wire Holding forceps, Wire Tightening Pliers, Flat-nosed Pliers



**23-167**  
DUROGRIP  
Holding forceps for cerclage  
wire, with lateral jaws to avoid  
wire slipping off  
170 mm



**23-168**  
DUROGRIP  
Wire, tightening pliers,  
Ligature pliers  
150 mm



**23-169**  
DUROGRIP  
Wire, tightening pliers,  
Ligature pliers  
150 mm



**23-170**  
with serrated jaws  
140 mm



**23-171**  
one jaws smooth,  
one jaws serrated  
140 mm



**23-172**  
with serrated jaws  
**23-173**  
with longitudinal and  
transversal grooves  
170 mm



**23-174**  
190 mm

# Wire Holding forceps, Flat-nosed Pliers, Pliers for bending and cutting wires

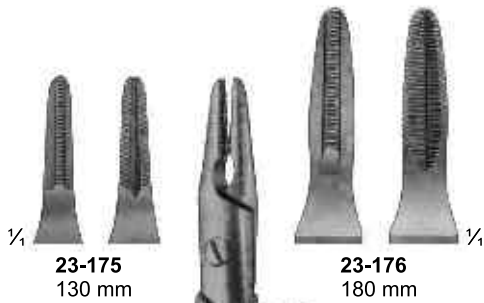

**23-175**  
130 mm

**23-176**  
180 mm



**23-175 - 176**  
Extraction pliers  
for boring wires

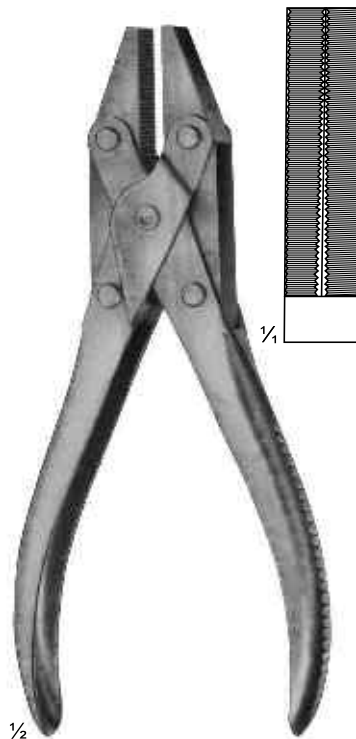

**23-177**  
Flat-nosed pliers,  
parallel  
185 mm

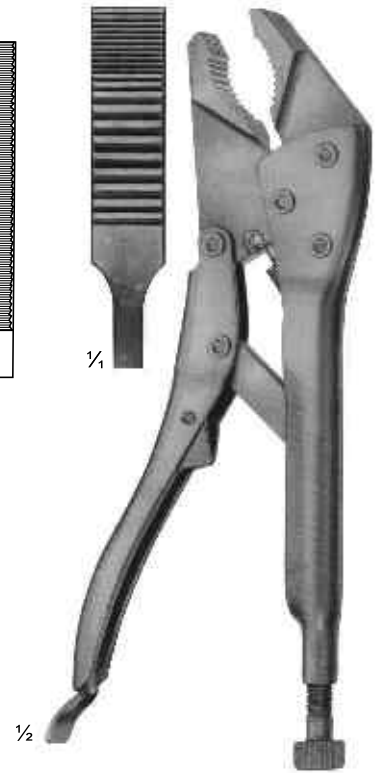

**23-178**  
Vise grip  
200 mm

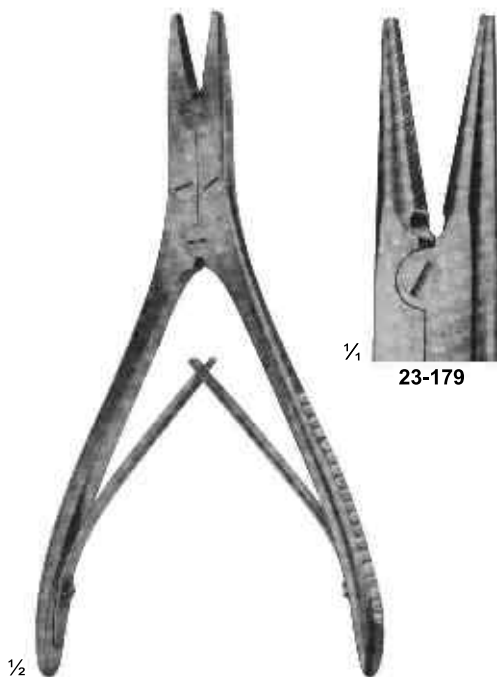

**23-179 - 183**  
Round pliers  
180 mm



**23-179**



**23-180**



**23-181**



**23-182**



**23-183**

**23-180**  
**23-181** 145 mm  
**23-182** 180 mm  
**23-183** 180 mm  
Extraction pliers for wires

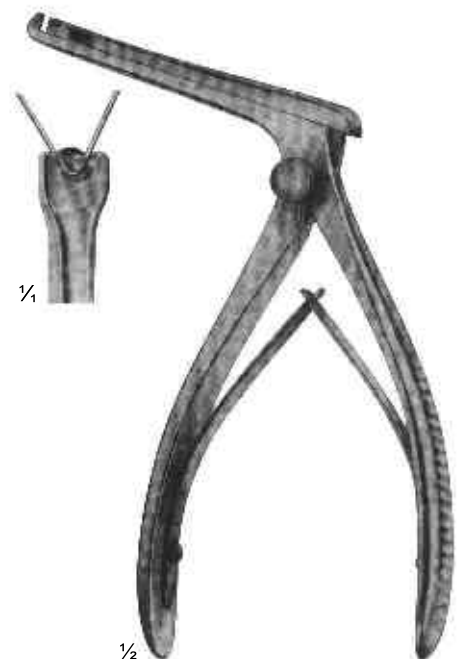

**23-184**  
Bending pliers  
for wires up to  
1.8 mm diam.

# Wire Cutters and wire Cutting Scissors

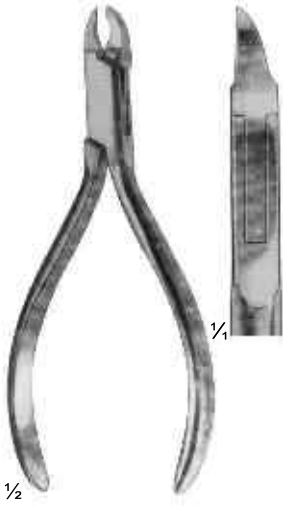

**23-185**  
ANGLE  
130 mm

for soft wire  
up to diam.  
for hard wire  
up to diam.

**23-186**  
DUROTIP  
ANGLE  
130 mm

0,5 mm 0,6 mm  
0,3 mm 0,4 mm

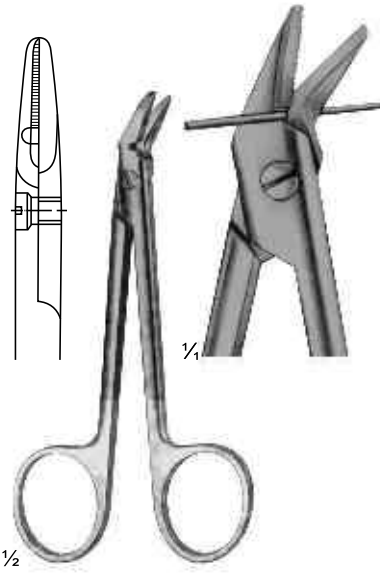

**23-187**  
120 mm

for soft wire  
up to diam.  
for hard wire  
up to diam.

**23-188**  
DUROTIP  
120 mm

1,2 mm 1,2 mm  
0,8 mm 0,8 mm

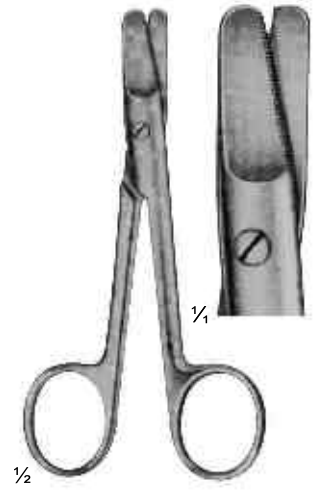

**23-189**  
HARVEY  
125 mm

0,4 mm  
0,3 mm

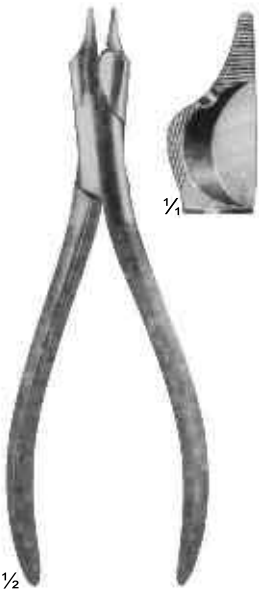

**23-190**  
150 mm

for soft wire  
up to diam  
for hard wire  
up to diam

1,5 mm  
1,0 mm



**23-191**  
160 mm

1,5 mm  
1,2 mm



**23-192**  
140 mm

1,5 mm  
1,0 mm

# Wire Cutting Pliers, Lateral Cutting Action

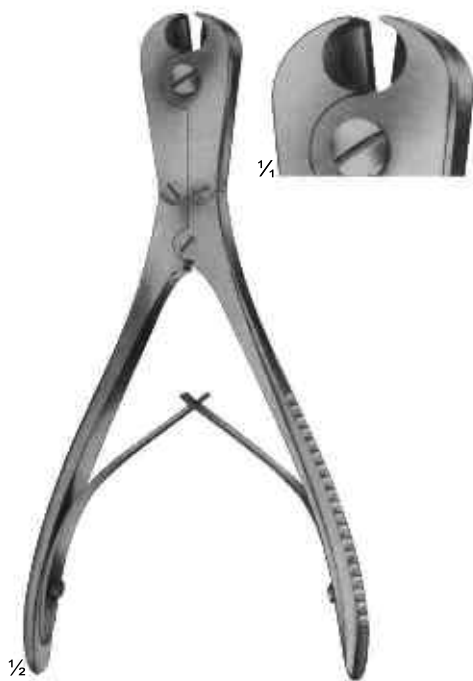

**23-193**  
180 mm

for soft wire  
up to diam. 2,0 mm  
For hard wire 1,5 mm  
up to diam  
specially hardened  
cutting edges, front  
and lateral cutting  
action



**23-194**  
REILL  
175 mm

for soft wire  
up to diam. 2,0 mm  
For hard wire 1,6 mm  
up to diam  
specially hardened  
cutting edges, for  
cutting off wires close  
to the bone



**23-195**  
235 mm

for soft wire  
up to diam. 3,0 mm  
For hard wire 2,2 mm  
up to diam

# Wire Cutting Pliers, Lateral and Front Cutting Action

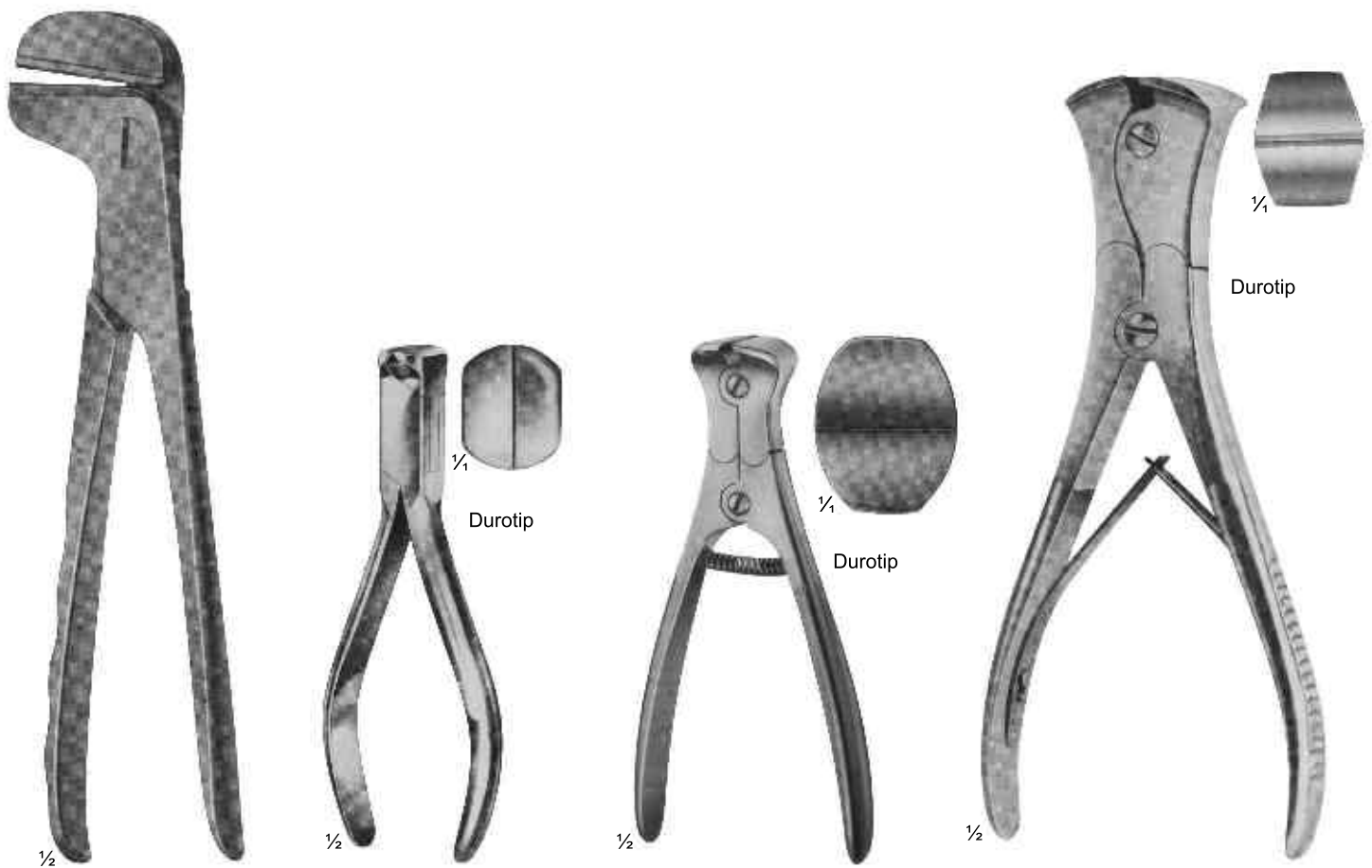

**23-196**  
240 mm

for soft wire  
up to diam.  
For hard wire  
up to diam

2,0 mm  
1,6 mm

**23-197**  
140 mm

for soft wire  
up to diam.  
For hard wire  
up to diam

1,5 mm  
1,0 mm

**23-198**  
145 mm

for soft wire  
up to diam.  
For hard wire  
up to diam

2,0 mm  
1,5 mm

**23-199**  
220 mm

for soft wire  
up to diam.  
For hard wire  
up to diam

3,5 mm  
2,5 mm



# Wire Cutting Pliers



1/2

Cutter for cutting off  
KIRSCHNER wires,  
Tibia head screws,  
bolts, pins, up to 3 mm diam.

**23-200**  
320 mm

for soft wire up to diam. 3,0 mm  
For hard wire up to diam 3,0 mm



Durotip

**23-201**  
Cutter for cutting off  
KIRSCHNER wires,  
Tibia head screws,  
bolts, pins, up to 6 mm diam.  
470 mm

# Finger Nail Instruments

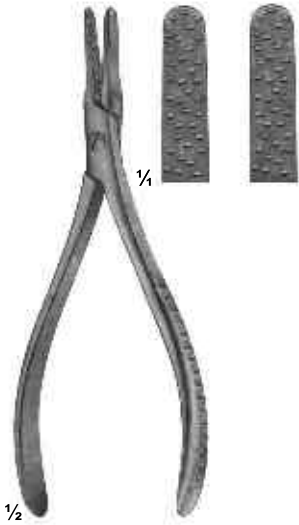

**23-202**  
Nail extracting  
forceps  
135 mm



**23-203**  
Nail extracting  
forceps  
145 mm

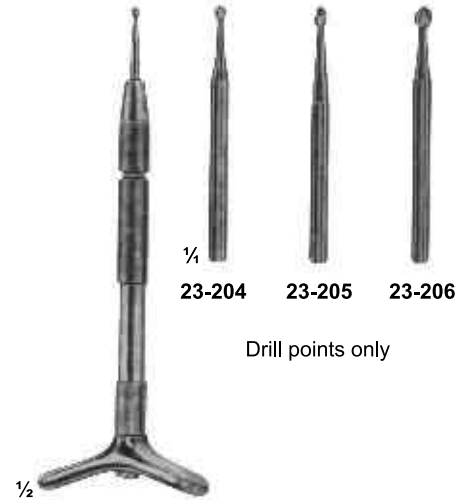

**23-204 - 206**  
Finger nail drill  
with 3 points

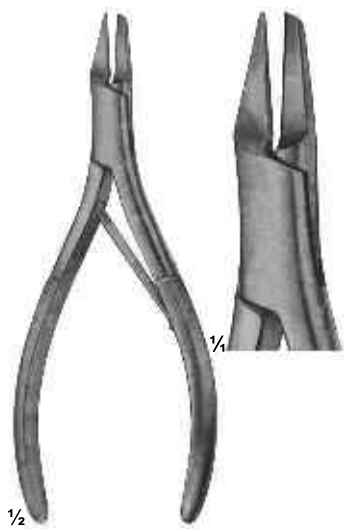

**23-207**  
Nail splitting  
forceps  
135 mm



**23-208**  
SYSTRUNK  
Scissors, for splitting  
finger nails  
130 mm

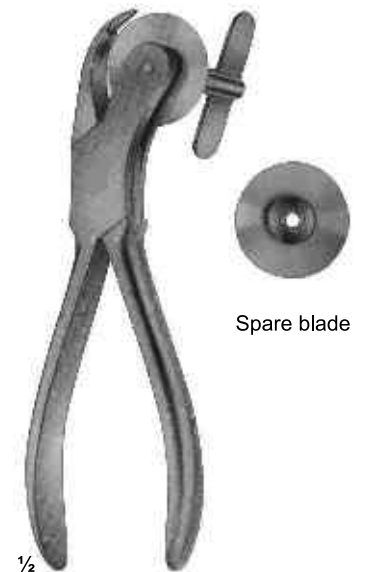

**23-209**  
Finger ring saw  
150 mm

# Plaster Instruments



with ebony handle

**24-101**  
HOPKINS  
200 mm



**24-102**  
ESMARCH  
180 mm



**24-103**  
ENGEL  
160 mm



1/2

**24-104 - 112**

- |               |       |               |             |
|---------------|-------|---------------|-------------|
| <b>24-104</b> | black | <b>24-108</b> | yellow      |
| <b>24-105</b> | red   | <b>24-109</b> | white       |
| <b>24-106</b> | blue  | <b>24-110</b> | orange      |
| <b>24-107</b> | green | <b>24-111</b> | lavender    |
|               |       | <b>24-112</b> | bright pink |



1/2

**24-113 - 121**

- |               |       |               |             |
|---------------|-------|---------------|-------------|
| <b>24-113</b> | black | <b>24-117</b> | yellow      |
| <b>24-114</b> | red   | <b>24-118</b> | white       |
| <b>24-115</b> | blue  | <b>24-119</b> | orange      |
| <b>24-116</b> | green | <b>24-120</b> | lavender    |
|               |       | <b>24-121</b> | bright pink |

# Plaster Scissors

For small plaster dressings

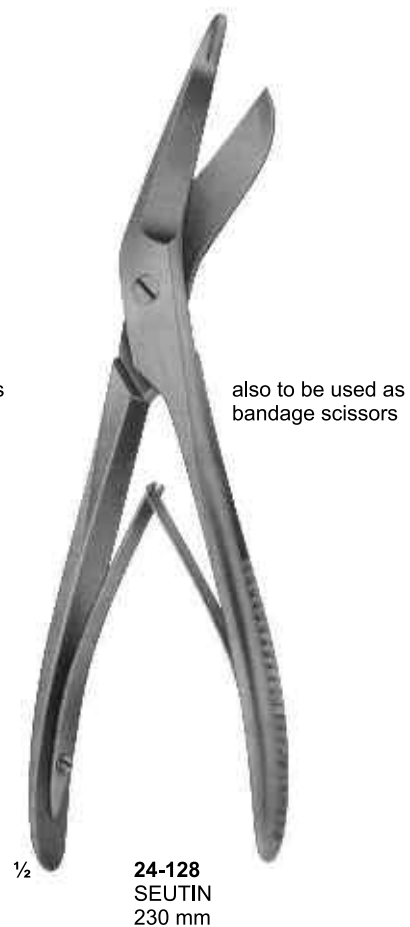
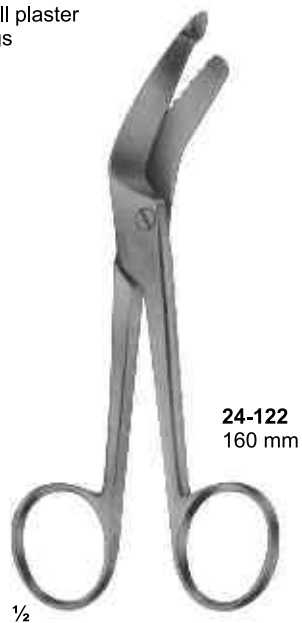

# Plaster Shears



**24-129**  
STILLE-AESFULAP  
260 mm



**24-130**  
STILLE-AESFULAP  
360 mm

# STILLE Plaster Shears

Blade with reinforced back



**24-131**  
STILLE  
230 mm

**24-132**  
Spare blade



**24-133**  
STILLE  
370 mm

**24-134**  
Spare blade



**24-135**  
STILLE  
240 mm

**24-136**  
Spare blade

# Plaster Spreader, Plaster Breakers



1/2

**24-137**  
HENING  
270 mm



1/2

**24-138**  
MOD.USA  
230 mm



1/2

**24-139**  
290 mm



with removable jaws



1/2

**24-140 - 141**  
WOLFF  
**24-140** 180 mm  
**24-141** 240 mm

# Vacuum Currettes for Aspiration Lipectomy, Suction Instruments

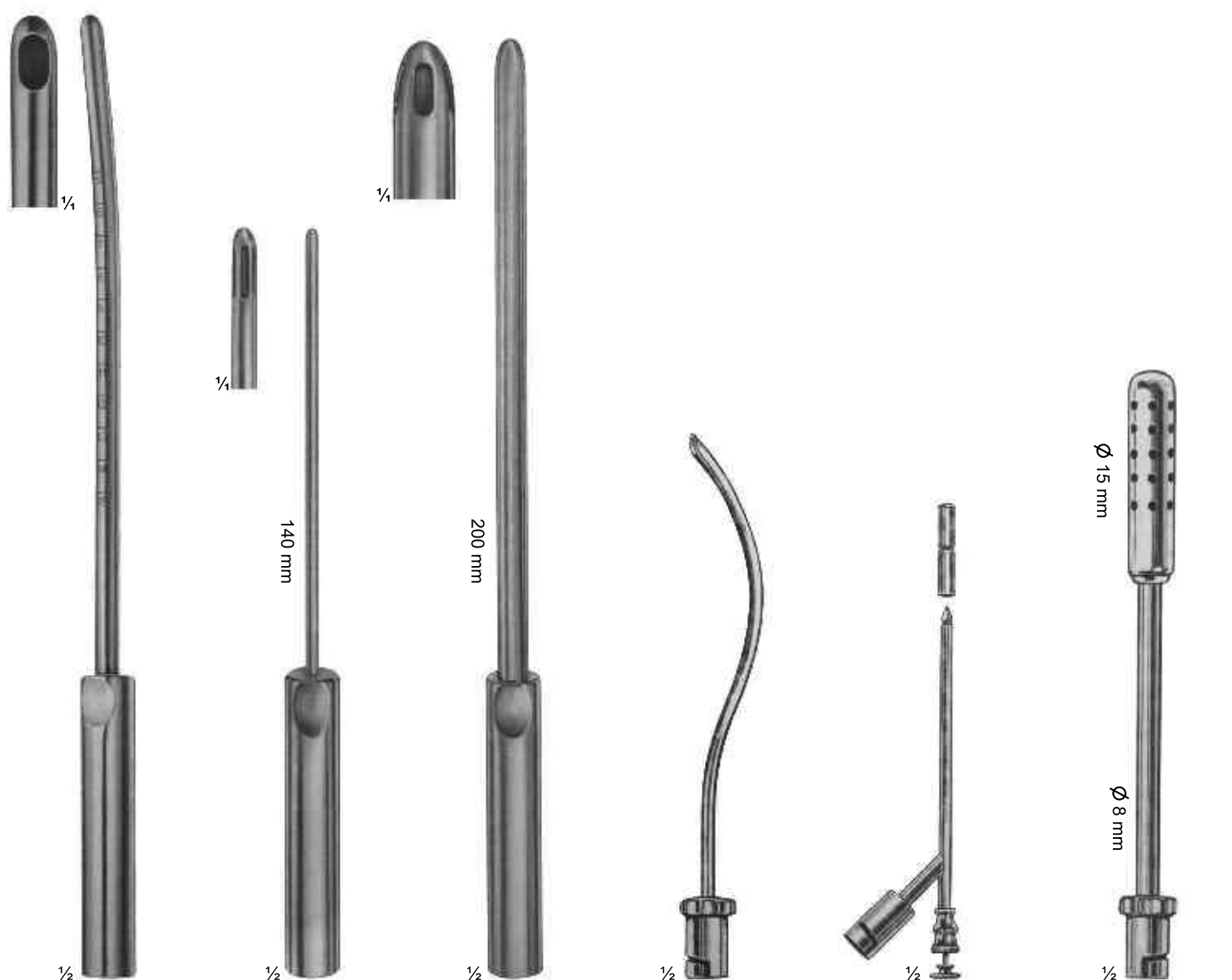

**25-101 - 106**  
**BIEMER**  
**25-101** ø 4 mm  
**25-102** ø 6 mm  
**25-103** ø 8 mm  
**25-104** ø 10 mm  
**25-105** ø 12 mm  
**25-106** ø 14 mm  
 Currettes for aspiration lipectomy, graduated, slightly curved

**25-107 - 108**  
**BIEMER**  
**25-107** ø 4 mm  
**25-108** ø 6 mm  
 Currettes for aspiration lipectomy, with three apertures, slightly curved malleable

**25-109 - 111**  
**BIEMER**  
**25-109** ø 8 mm  
**25-110** ø 10 mm  
**25-111** ø 12 mm  
 Currettes for aspiration lipectomy, with three apertures, slightly curved malleable

**25-112**  
 For aspirating fluid from the excretory ducts of large glands and for keeping the operating area clear  
 170 mm

**25-113**  
 Trocar  
 For puncturing  
 150 mm

**25-114**  
 For clearing large quantities of fluid  
 190 mm



# Suction Instruments



1/2

**25-115**  
Trocar  
For puncturing  
170 mm



1/2

**25-116**  
Hollow needle,  
sharp  
150 mm



1/2

**25-117**  
double curved  
For general  
surgery  
230 mm

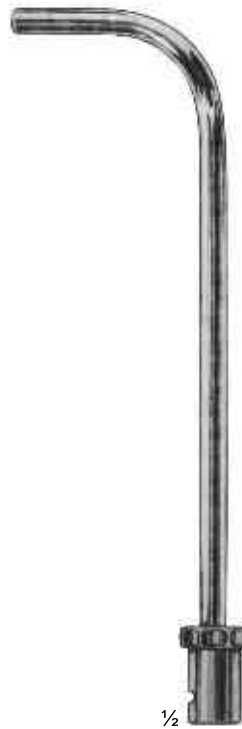

1/2

**25-118**  
For tonsillectomy,  
oral and laryngeal  
operations  
190 mm



1/2

**25-119**  
For tonsillectomy,  
oral and laryngeal  
operations  
220 mm

# Suction Instruments

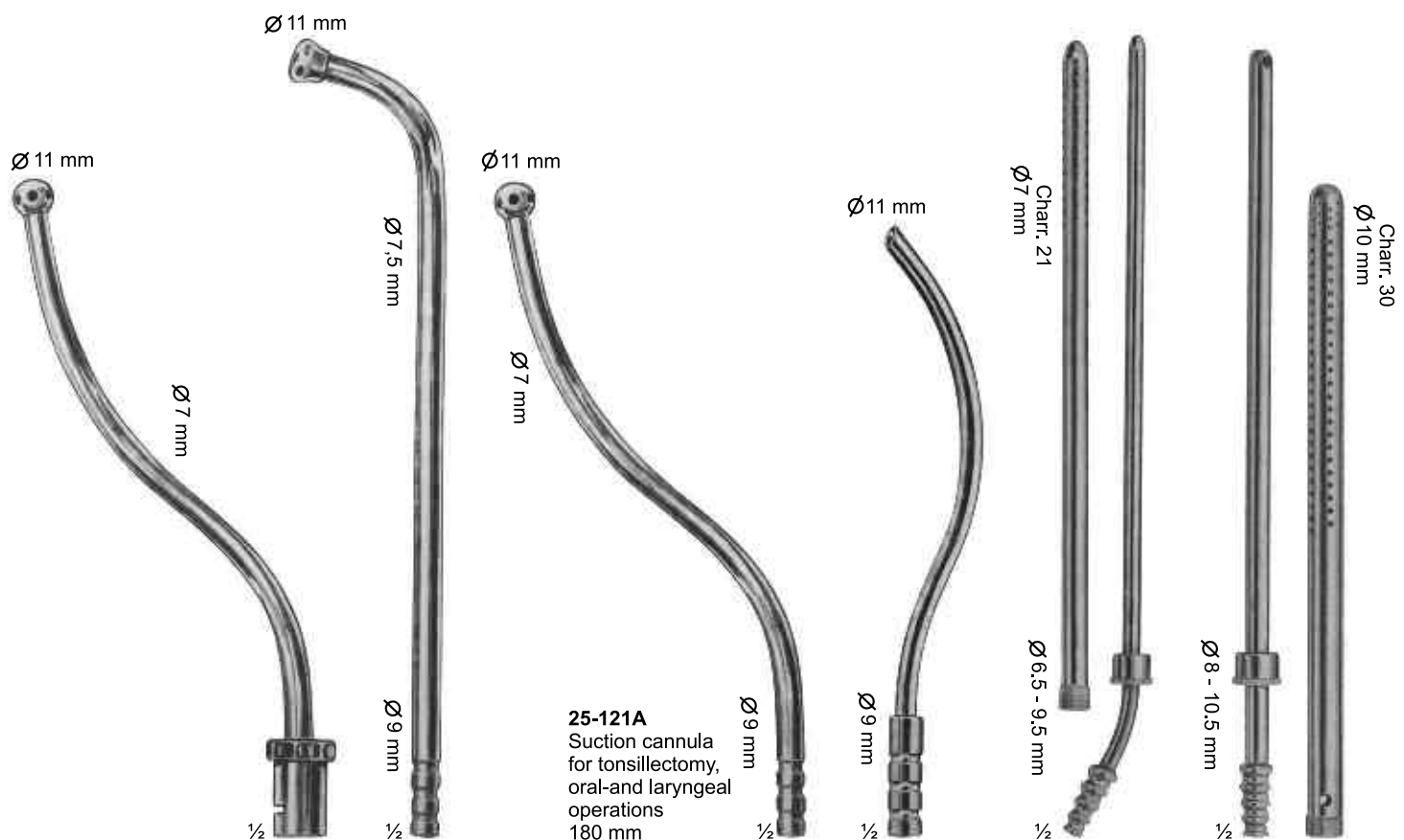

**25-120**  
For tonsillectomy,  
oral-and laryngeal  
operations  
180 mm

**25-121**  
Suction cannula  
for tonsillectomy,  
oral-and laryngeal  
operations  
220 mm

**25-121A**  
Suction cannula  
for tonsillectomy,  
oral-and laryngeal  
operations  
180 mm

**25-122**  
S-shaped blunt cannula  
for aspirating fluid from  
the excretory ducts of  
large glands and for  
keeping the operations  
area clear  
170 mm

**25-123**  
POOL  
Suction cannula,  
with outer tube  
to be screwed of  
225 mm

**25-124**  
POOL  
Suction cannula,  
with outer tube  
to be screwed of  
225 mm

# Suction Instruments

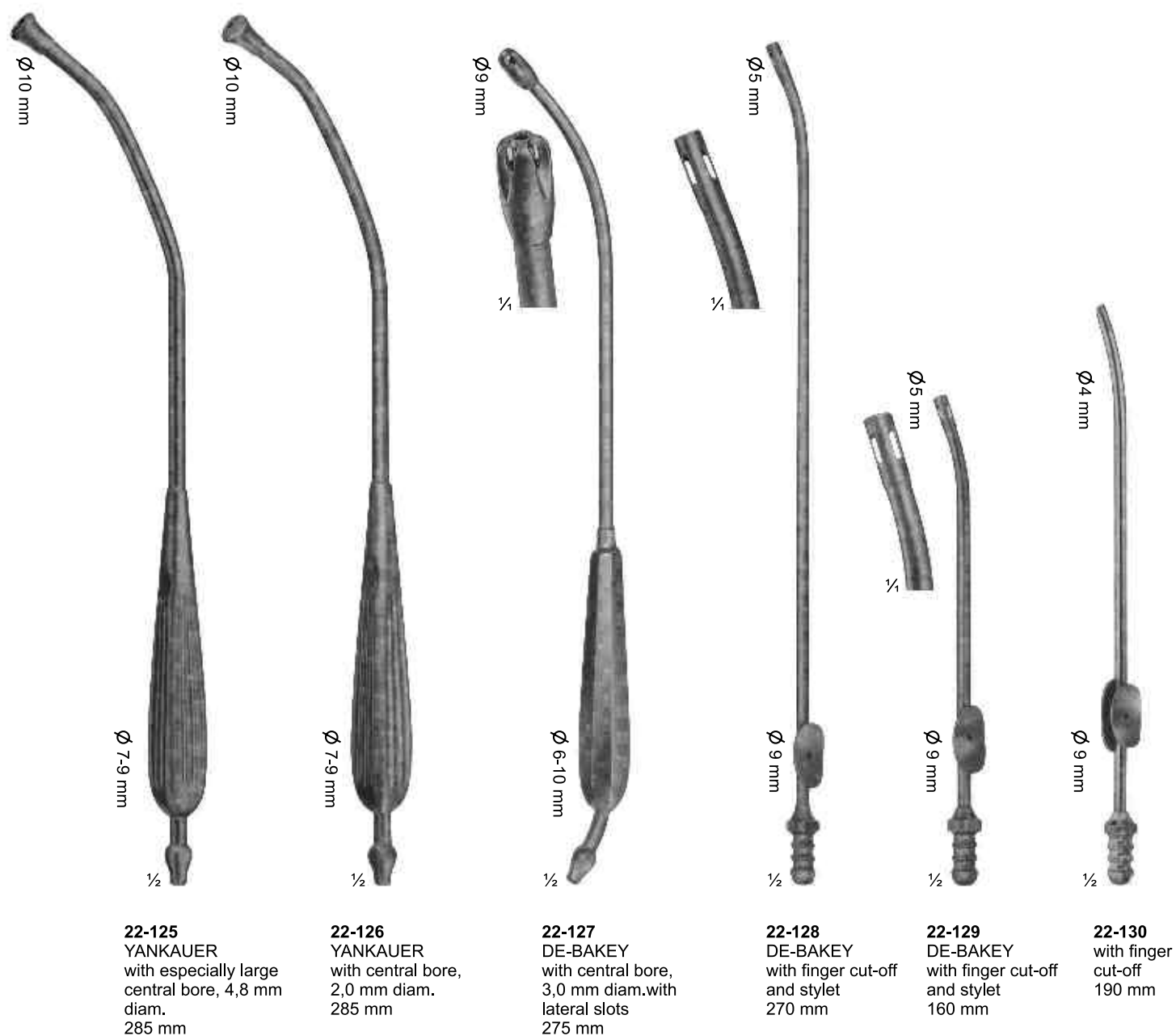

**22-125**  
YANKAUER  
with especially large  
central bore, 4,8 mm  
diam.  
285 mm

**22-126**  
YANKAUER  
with central bore,  
2,0 mm diam.  
285 mm

**22-127**  
DE-BAKEY  
with central bore,  
3,0 mm diam.with  
lateral slots  
275 mm

**22-128**  
DE-BAKEY  
with finger cut-off  
and stylet  
270 mm

**22-129**  
DE-BAKEY  
with finger cut-off  
and stylet  
160 mm

**22-130**  
with finger  
cut-off  
190 mm

# Suction Instruments

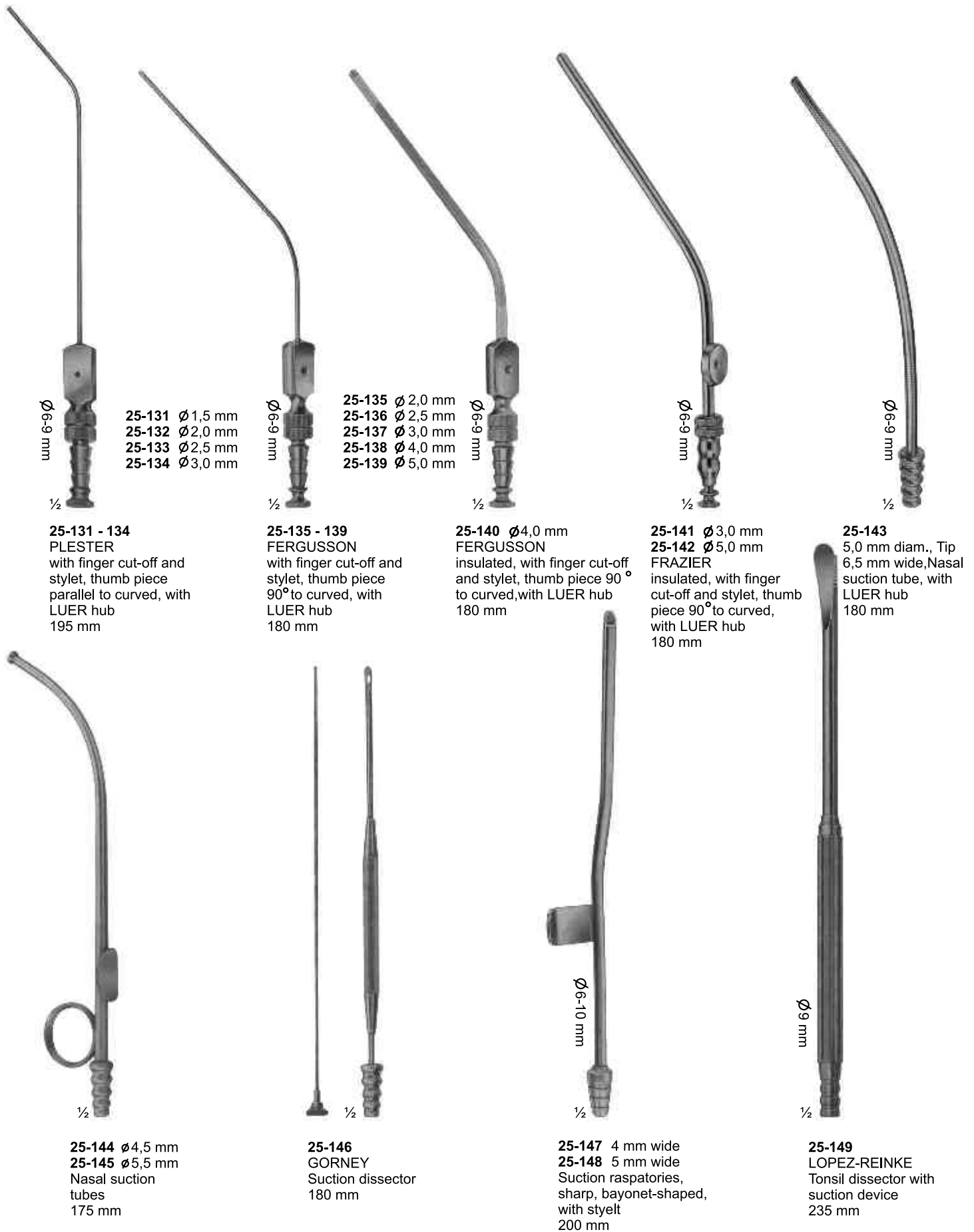

# Suction Instruments

**25-150**  
WULLSTEIN  
Suction tube, conical, silver, oliver  
with LUER hub  
160 mm

$\varnothing 1,75$  mm

$\varnothing 3$  mm  
 $\frac{1}{2}$   
 $\varnothing 8$  mm

**25-151** 1,5 mm  
**25-152** 2,0 mm  
WULLSTEIN  
Suction tube, cylindrical, silver, with  
stylet with LUER hub  
160 mm

$\frac{1}{2}$   
 $\varnothing 8$  mm

Usable length

YASARGIL usable length diam.		YASARGIL usable length diam.	
<b>25-153</b>	130 mm 1,5 mm	<b>25-161</b>	130 mm 2,5 mm
<b>25-154</b>	150 mm 1,5 mm	<b>25-162</b>	150 mm 2,5 mm
<b>25-155</b>	180 mm 1,5 mm	<b>25-163</b>	180 mm 2,5 mm
<b>25-156</b>	220 mm 1,5 mm	<b>25-164</b>	220 mm 2,5 mm
<b>25-157</b>	130 mm 2,0 mm	<b>25-165</b>	130 mm 3,5 mm
<b>25-158</b>	150 mm 2,0 mm	<b>25-166</b>	150 mm 3,5 mm
<b>25-159</b>	180 mm 2,0 mm	<b>25-167</b>	180 mm 3,5 mm
<b>25-160</b>	220 mm 2,0 mm	<b>25-168</b>	220 mm 3,5 mm
		<b>25-169</b>	180 mm 4,5 mm

$\varnothing 6,5-9$  mm  
with LUER hub

**25-170 - 172**  
LANDOLT  
150 MM  
diam  $\varnothing 3$  mm

**25-170** 8 mm / curved  
**25-171** 11 mm / curved  
**25-172** 15 mm / curved

$\frac{1}{2}$   
 $\frac{1}{2}$

$\varnothing 3.5$  mm

$\varnothing 2.0$  mm

**25-173** 500 mm  
**25-174** 350 mm  
with rubber tip,  
with LUER hub

$\varnothing 9$  mm  
 $\frac{1}{2}$

**25-175** 2,0 mm diam  
**25-176** 2,5 mm diam  
**25-177** 3,0 mm diam  
with finger cut-off,  
thumb piece 90° to  
curved, with LUER hub  
250 mm

$\varnothing 6-9$  mm  
 $\frac{1}{2}$

# Combined Suction and Irrigation Cannulae



**25-178**  
FINSTERER  
320 mm

Ø9-13 mm 1/2

Ø 15 mm



Ø 2 mm

Ø 4,5 mm

1/2

**25-179**  
YASARGIL  
LURE-LOCK cone  
200 mm



Ø 2,5 mm

175 mm

**25-180**  
with finger cut-off and stylet,

4,5 mm 1/2

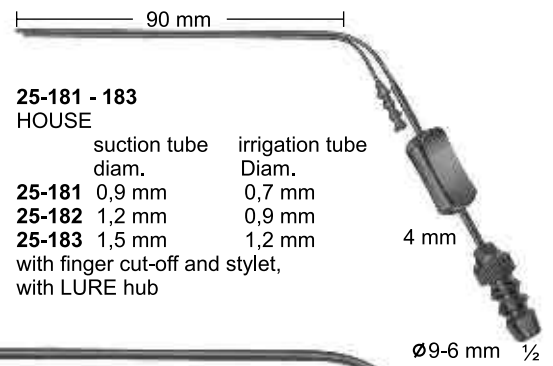

90 mm

**25-181 - 183**  
HOUSE

	suction tube diam.	irrigation tube Diam.
<b>25-181</b>	0,9 mm	0,7 mm
<b>25-182</b>	1,2 mm	0,9 mm
<b>25-183</b>	1,5 mm	1,2 mm

with finger cut-off and stylet,  
with LURE hub

4 mm

Ø9-6 mm 1/2

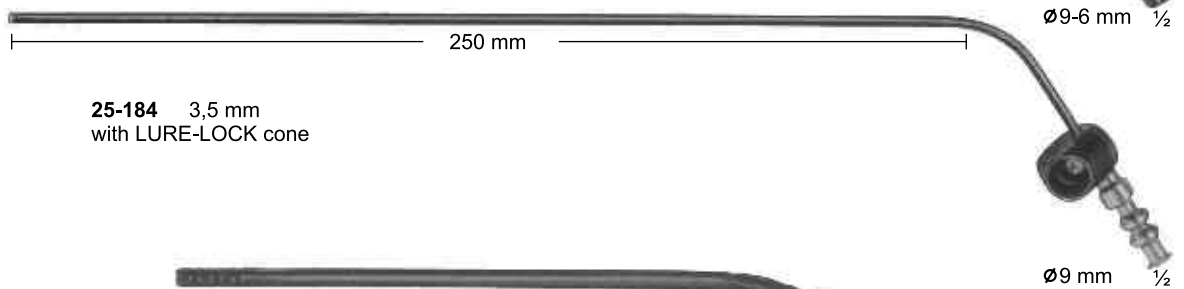

**25-184** 3,5 mm  
with LURE-LOCK cone

250 mm

Ø9 mm 1/2

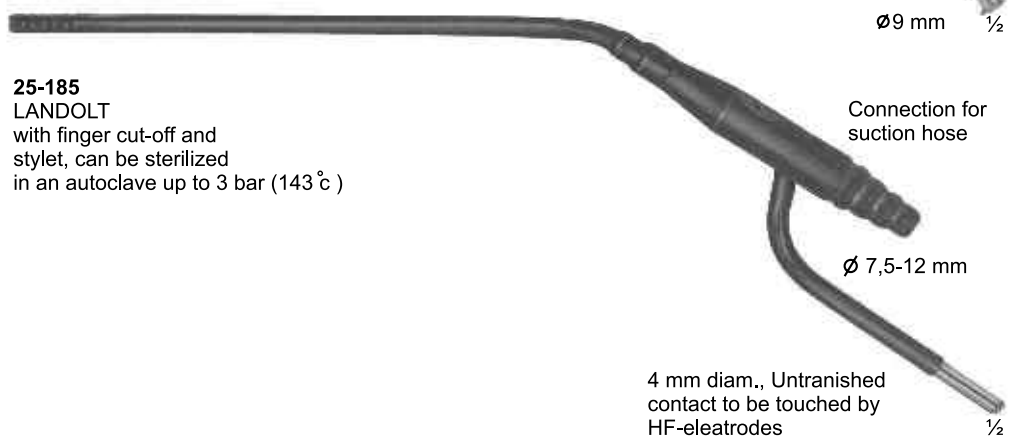

**25-185**  
LANDOLT  
with finger cut-off and stylet, can be sterilized in an autoclave up to 3 bar (143 °C)

Connection for suction hose

Ø 7,5-12 mm

4 mm diam., Untrashed contact to be touched by HF-electrodes

1/2

# Scissors with Tungsten Carbide Inserts



**26-101**  
Standard

14,5cm  
16,5cm  
18,5cm



**26-102**  
Standard

14,5cm  
16,5cm  
18,5cm



**26-103**  
Standard

14,5cm  
16,5cm  
18,5cm



**26-104**  
Standard

14,5cm  
16,5cm  
18,5cm



**26-105**  
Standard

14,5cm  
16,5cm  
18,5cm



**26-106**  
Standard

14,5cm  
16,5cm  
18,5cm

# Scissors with Tungsten Carbide Inserts



**26-107**  
Mayo-Lexer

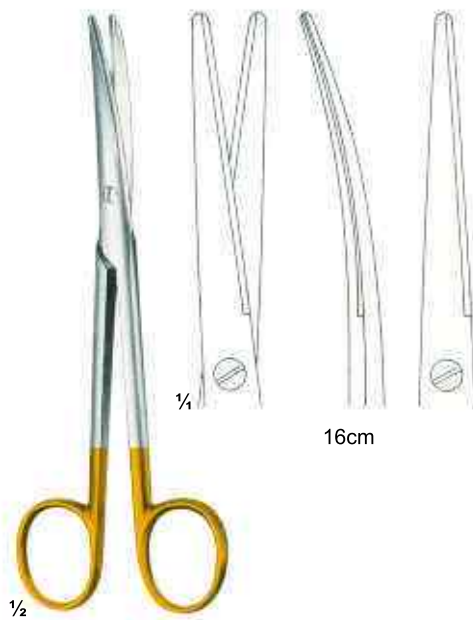

**26-108**  
Mayo-Lexer



**26-109**  
Lexer

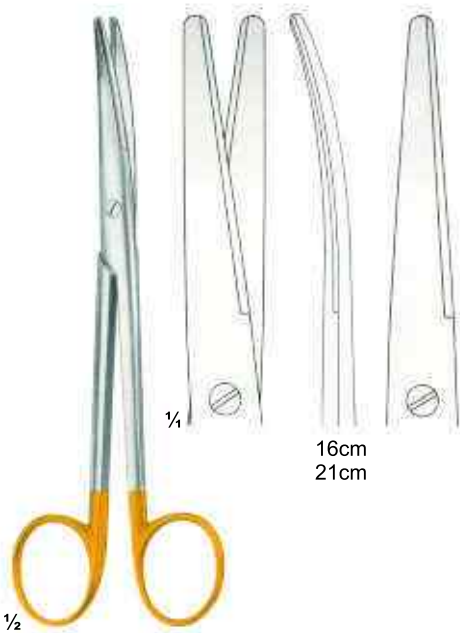

**26-110**  
Lexer

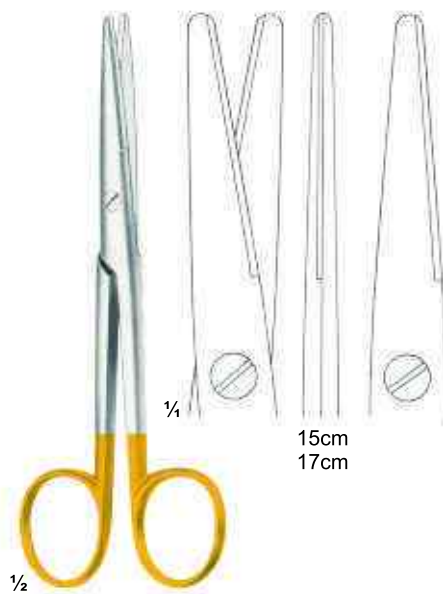

**26-111**  
Mayo-Stille

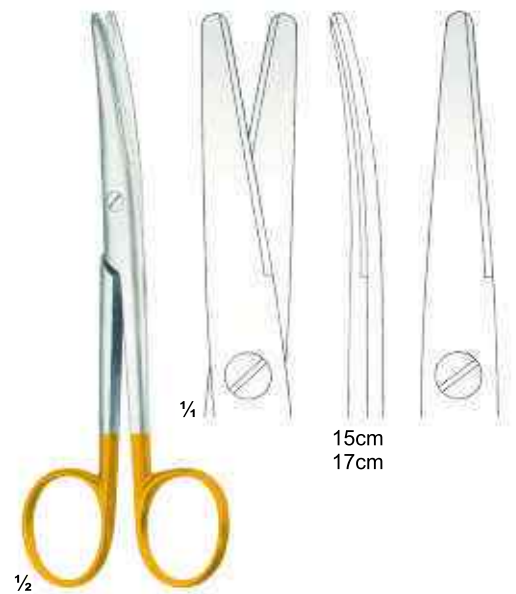

**26-112**  
Mayo-Stille



# Scissors with Tungsten Carbide Inserts



# Scissors with Tungsten Carbide Inserts

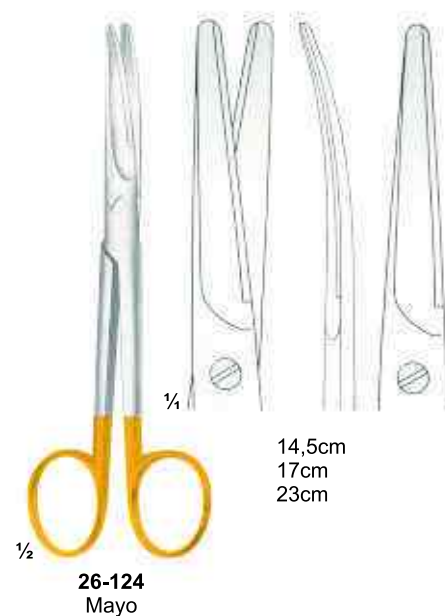
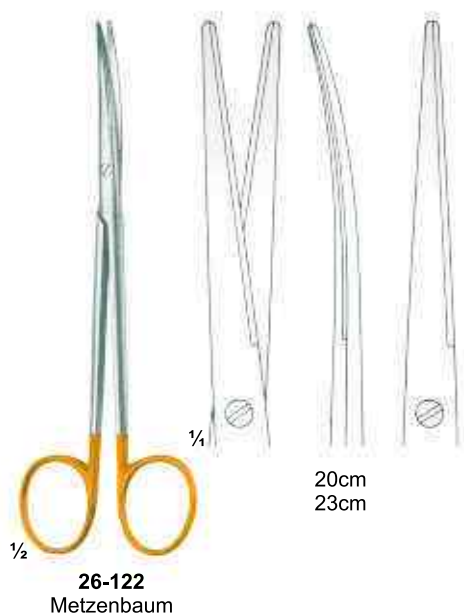
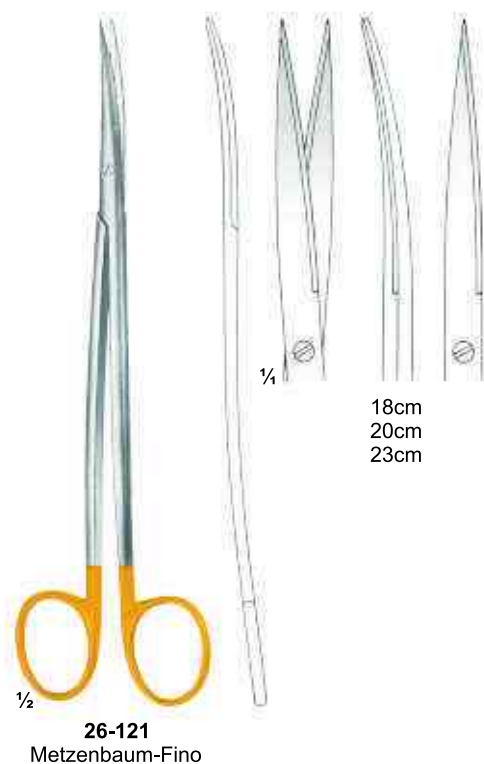
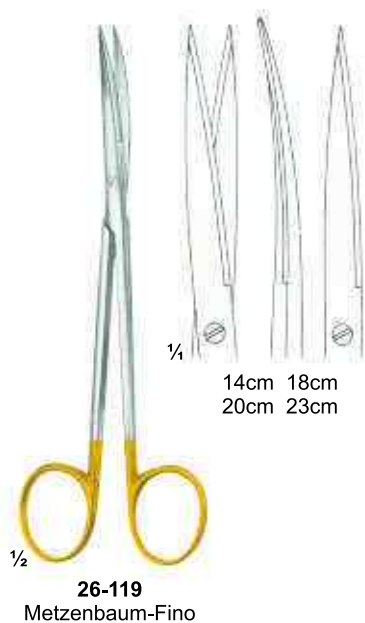

## Scissors with Tungsten Carbide Inserts

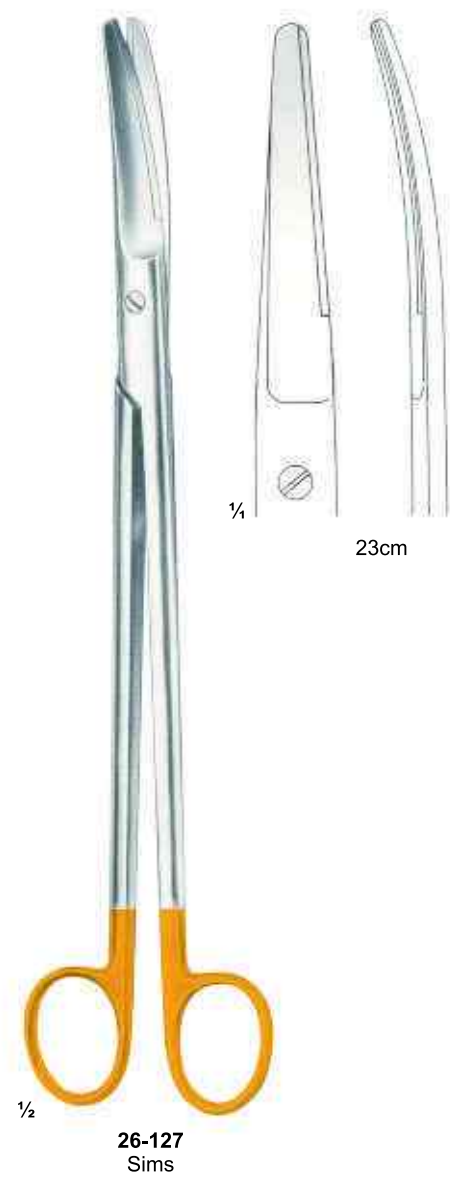
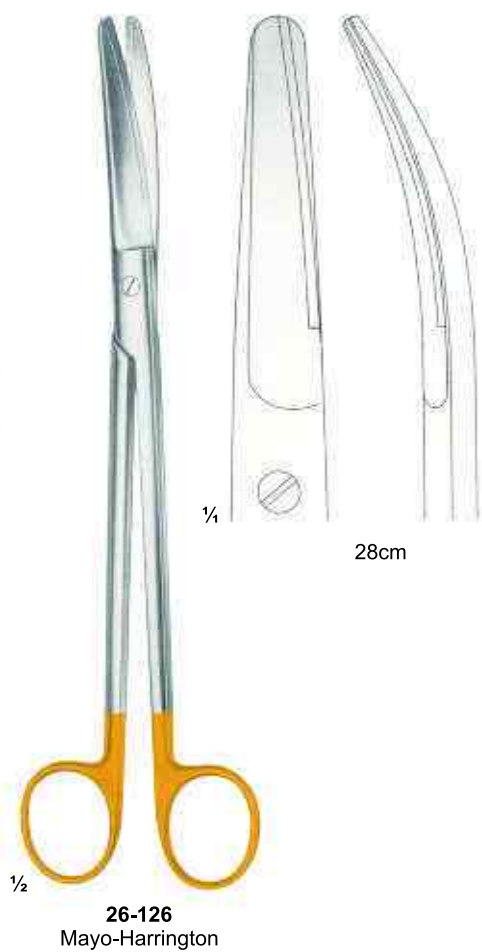

# Scissors with Tungsten Carbide Inserts

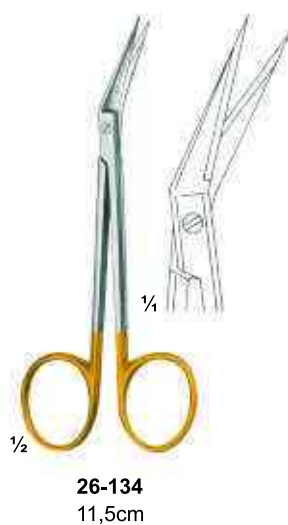
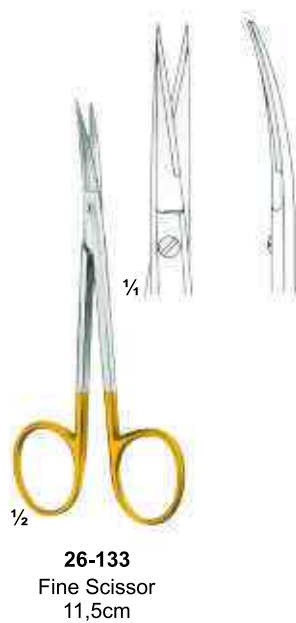
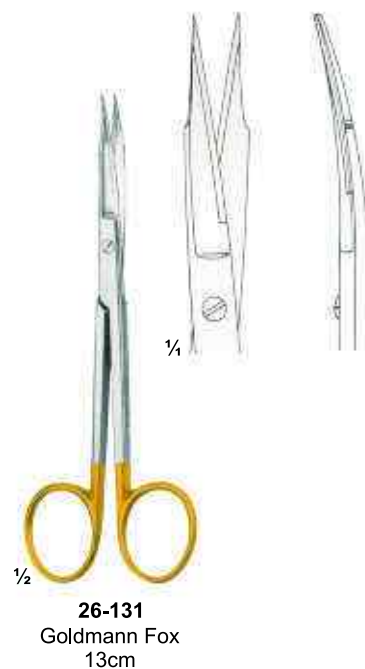
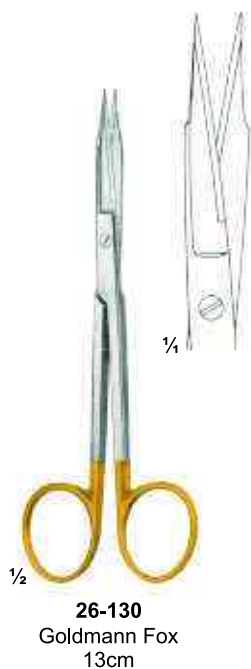

# Scissors & Dissecting Forceps with Tungsten Carbide Inserts

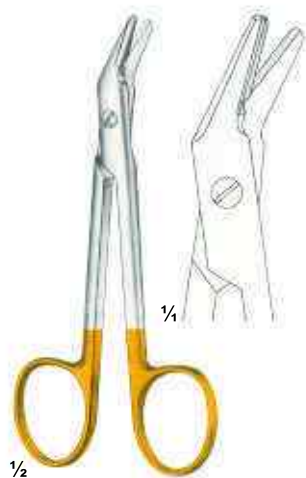

**26-136**  
Universal  
12cm



**26-137**  
Ligature Scissors  
1 Black & 1 Goldplated ring



**26-138**  
Adson



**26-139**  
Cushing  
17,5cm



**26-140**  
Cushing  
18cm



**26-141**  
Cushing-Taylor  
18cm



**26-142**  
Dissecting Forceps  
15cm



**26-143**  
Semken  
15cm

# Dissecting Forceps and Needle holders with Tungsten Carbide Inserts



**26-144**  
Wangensteen

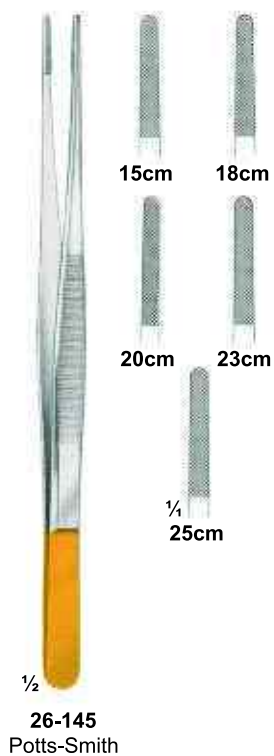

**26-145**  
Potts-Smith

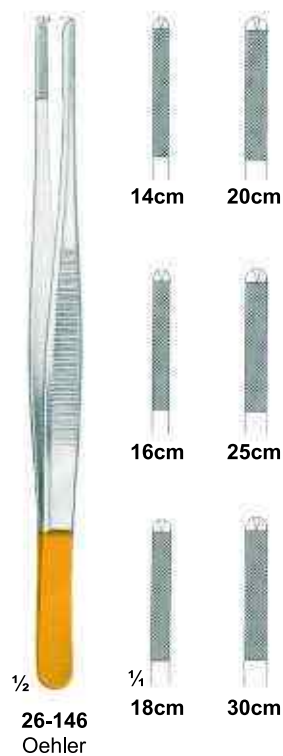

**26-146**  
Oehler





# Needle holders with Tungsten Carbide Inserts



**26-152**  
Arruga  
16cm



**26-153**  
Castroviejo  
13cm

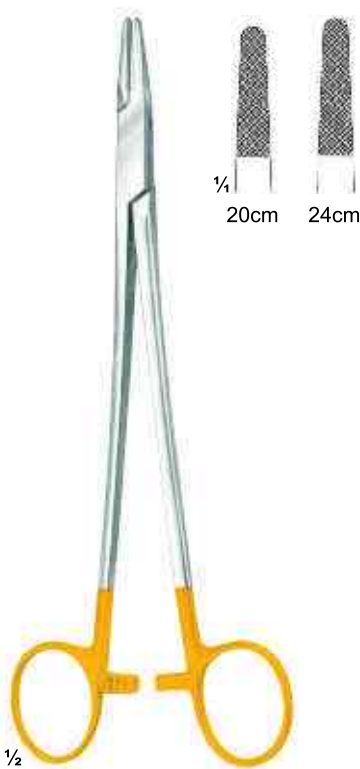

**26-154**  
Hegar  
20cm 24cm

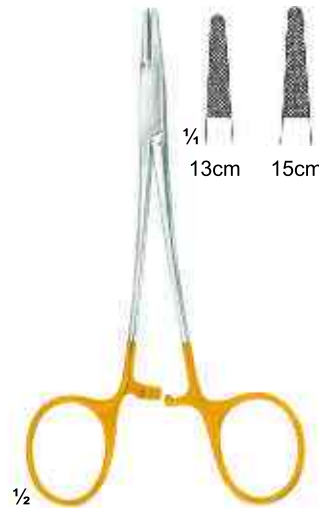

**26-155**  
Halsey  
13cm 15cm

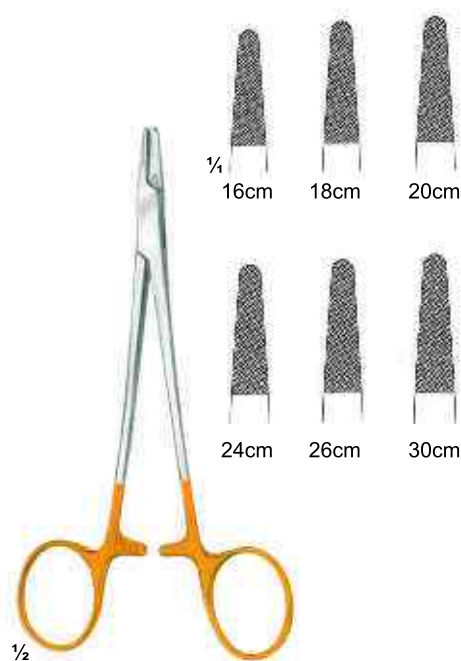

**26-156**  
Mayo-Hegar  
16cm 18cm 20cm  
24cm 26cm 30cm

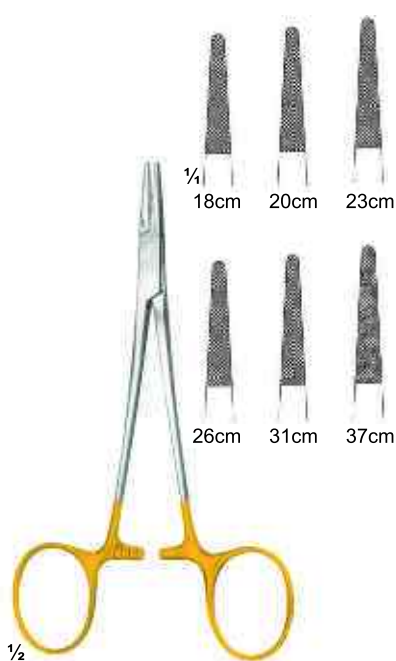

**26-157**  
De-Bakey  
18cm 20cm 23cm  
26cm 31cm 37cm

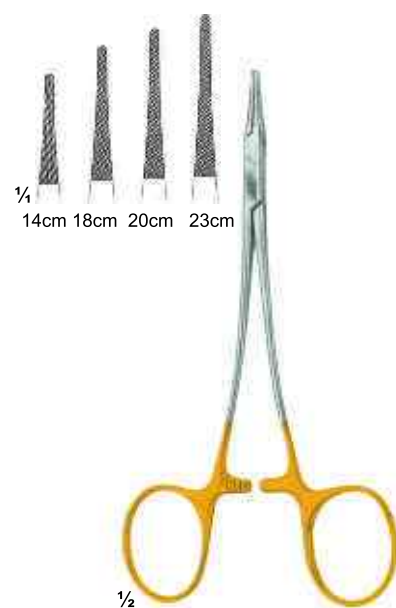

**26-158**  
Hegar-Vascular  
14cm 18cm  
20cm 23cm

# Needle holders with Tungsten Carbide Inserts

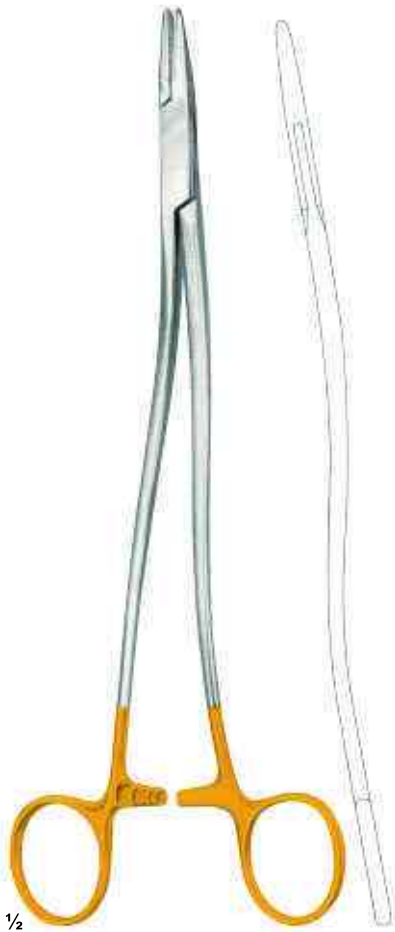

$\frac{1}{2}$   
**26-159**  
 Bozemann-Wertheim  
 20cm 24cm 26cm



$\frac{1}{2}$   
**26-160**  
 Stratte  
 22cm 23cm

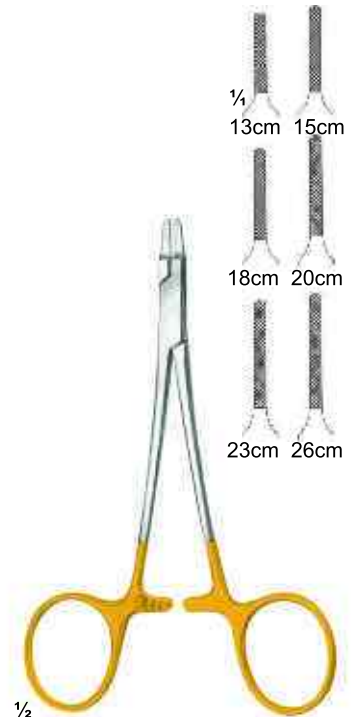

$\frac{1}{2}$   
**26-161**  
 Ryder  
 13cm 15cm 18cm  
 20cm 23cm 26cm



$\frac{1}{2}$   
**26-162**  
 Ryder-Vascular  
 13cm 15cm 18cm  
 20cm 23cm 26cm



$\frac{1}{2}$   
**26-163**  
 Martin  
 15cm 17cm 20cm



$\frac{1}{2}$   
**26-164**  
 Sarot  
 18cm 20cm 26cm



# Needle holders with Tungsten Carbide Inserts



# Needle holders with Tungsten Carbide Inserts



1/2  
**26-172**  
 Mathieu-Ryder  
 17cm  
 20cm 24cm



1/2  
**26-173**  
 Lichtenberg  
 20cm



1/2  
**26-174**  
 Langhals  
 20cm 25cm



1/2  
**26-175**  
 Lichtenberg  
 20cm 25cm



1/2  
**26-176**  
 Luehty-Beck  
 20cm 25cm

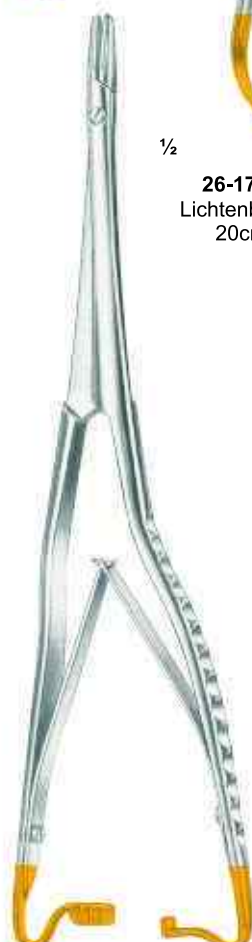

1/2  
**26-177**  
 Luehty-Beck  
 20cm 25cm



1/2  
**26-178**  
 Langebeck  
 18cm  
 20cm 23cm



1/2  
**26-179**  
 Langebeck-beck  
 18cm  
 20cm 23cm

# Hospital Wares



**27-101 - 115**  
Schimmelbusch

	Ø x H sizes in mm
<b>27-101</b>	80 x 80
<b>27-102</b>	105 x 120
<b>27-103</b>	140 x 140
<b>27-104</b>	160 x 120
<b>27-105</b>	160 x 150
<b>27-106</b>	190 x 150
<b>27-107</b>	190 x 190
<b>27-108</b>	240 x 160
<b>27-109</b>	240 x 240
<b>27-110</b>	290 x 160
<b>27-111</b>	290 x 240
<b>27-112</b>	340 x 160
<b>27-113</b>	340 x 340
<b>27-114</b>	390 x 190
<b>27-115</b>	390 x 290



**27-116**  
Box  
120 x 65 x 13 mm  
(without Bulldog clamps,  
without silicone tape)



**27-117**  
Box with support  
120 x 65 x 13 mm  
(ohne Bulldogklemmen)



**27-118**  
Box with support for  
needle electrodes,  
without instruments

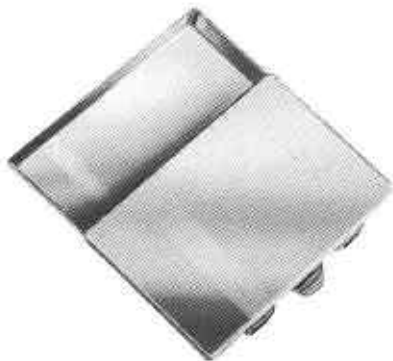

**27-119 - 121**  
50 x 25 x 4,5 mm  
**27-120**  
65 x 42 x 8 mm  
**27-121**  
75 x 25 x 4,5 mm



**27-122**  
Ø 65mm x 15mm

# Hospital Wares



27-123 - 131

	Ø x H
27-123	30 x 90 mm
27-124	50 x 100 mm
27-125	50 x 130 mm
27-126	50 x 175 mm
27-127	75 x 100 mm
27-128	75 x 130 mm
27-129	75 x 175 mm
27-130	100 x 175 mm
27-131	100 x 200 mm



27-132 - 139

27-132	165 x 85 x 35 mm
27-133	200 x 100 x 35 mm
27-134	200 x 100 x 50 mm
27-135	230 x 130 x 50 mm
27-136	260 x 150 x 50 mm
27-137	270 x 235 x 50 mm
27-138	300 x 200 x 50 mm
27-139	325 x 275 x 50 mm

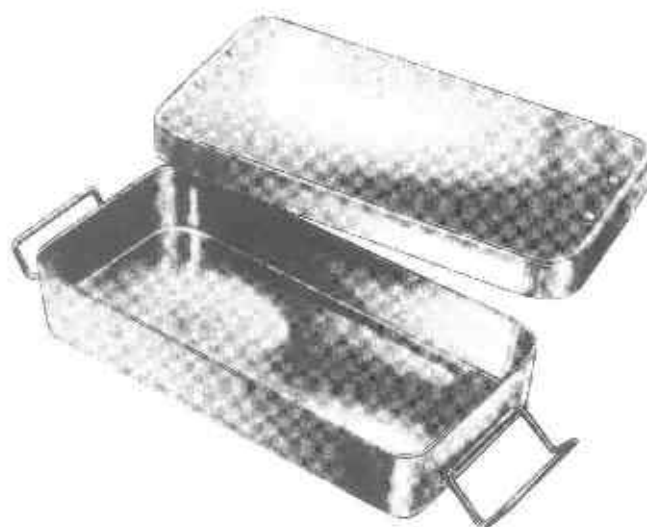

27-140  
205 x 105 x 35 mm

## Forceps Jars

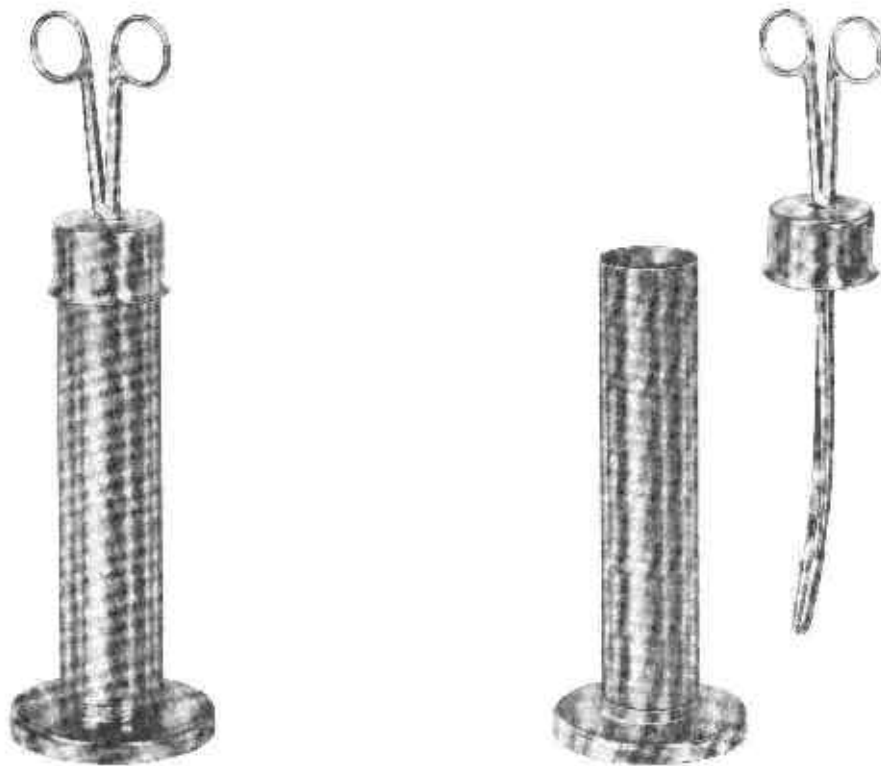

### 27-141 - 142

- |               |   |
|---------------|---|
| <b>27-141</b> | Martin Sterilizing Forceps<br>consisting of:<br>1 Sterilizing Forceps, curved, 25 cm,<br>without ratchet, with lid for jar<br>1 jar with bottom plate (anti-tilt) |
| <b>27-142</b> | ditto, with 32 cm long Sterilizing Forceps  |

# Round Metal Boxes and Medicine Cups



27-143 - 148

	Ø x H
27-143	75 x 60 mm
27-144	75 x 75 mm
27-145	100 x 60 mm
27-146	100 x 100 mm
27-146A	125 x 80 mm
27-147	125 x 125 mm
27-148	150 x 150 mm



27-149  
25 cc

27-150  
50 cc



27-151  
20 cc  
Medicine Spoon



27-152  
Ø75 x 12 mm  
Tablet Tray



27-153  
Ø90 x 90 mm  
Metal Cup



27-154  
Ø75 x 80 mm  
Sputum Cup

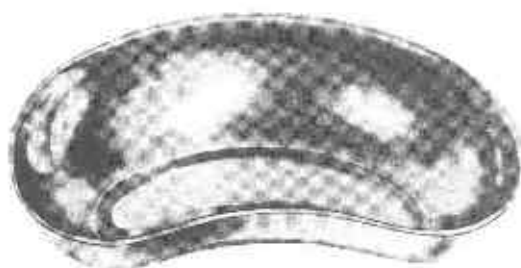

Kidney Dish

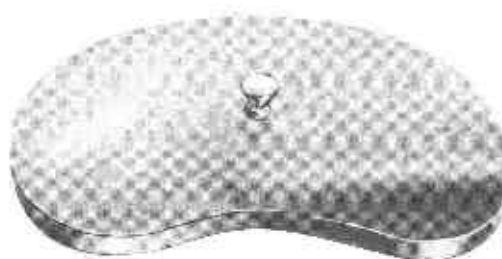

27-155 - 157

27-155	170 x 100 x 35 mm
27-156	250 x 140 x 40 mm
27-157	275 x 150 x 45 mm

# Hospital Wares



**27-158 - 165**

	Ø x H	
<b>27-158</b>	40 x 19 mm	0.05L
<b>27-159</b>	61 x 30 mm	0.07L
<b>27-160</b>	80 x 40 mm	0.14L
<b>27-161</b>	116 x 50 mm	0.35L
<b>27-162</b>	128 x 55 mm	0.45L
<b>27-163</b>	147 x 65 mm	0.70L
<b>27-164</b>	167 x 75 mm	1.10L
<b>27-165</b>	187 x 85 mm	1.60L

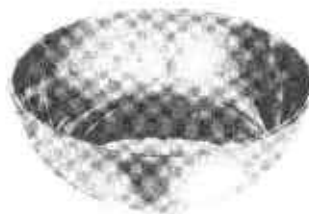

**27-166 - 170**

<b>27-166</b>	116 x 35 mm	0.30L
<b>27-167</b>	128 x 38 mm	0.40L
<b>27-168</b>	147 x 40 mm	0.50L
<b>27-169</b>	157 x 45 mm	0.75L
<b>27-170</b>	187 x 45 mm	1.00L



**27-171**  
Ø 110 x 28 mm 0.15L



**27-172**  
100 cc 0.1L



**27-173 - 176**  
**27-173** 0,25L  
**27-174** 0,50L  
**27-175** 1,00L  
**27-176** 2,00L



**27-177**  
235 x 190 x 40 mm



**27-178**  
Ø 220 x 70 mm



# Hospital Wares

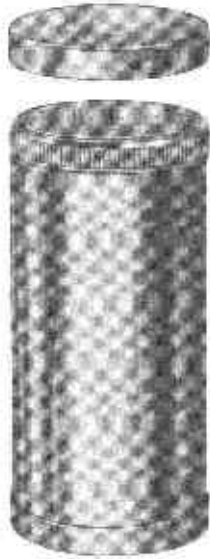

**27-179**  
 Ø 50 x 100 mm  
 Powder Pot



**27-180**  
 Ø 50 x 75 mm  
 Methot With Lid

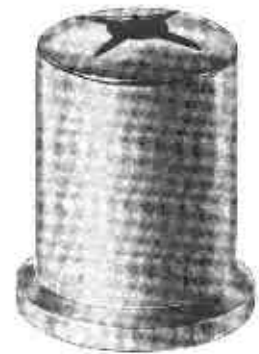

**27-181**  
 Ø 50 x 75 mm  
 Methot Without Lid

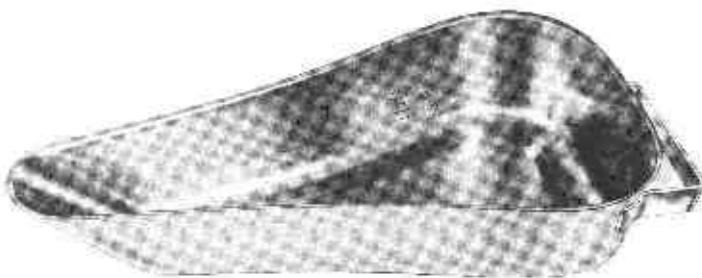

**27-182**

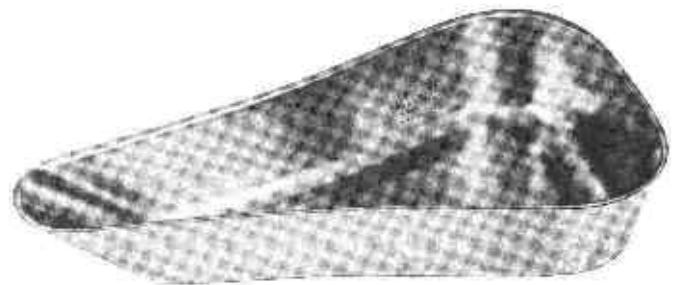

**27-183**

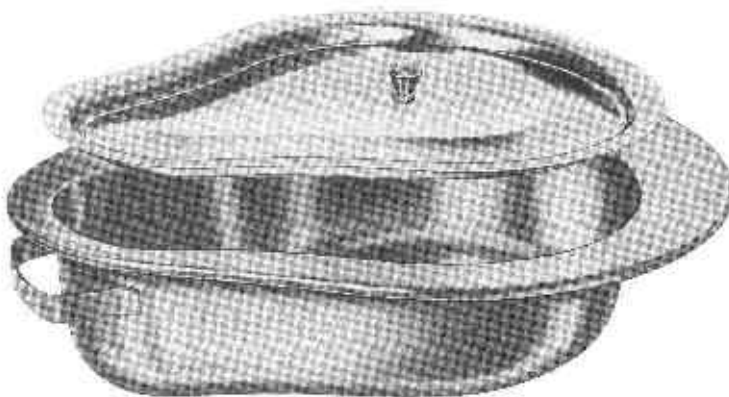

**27-184**

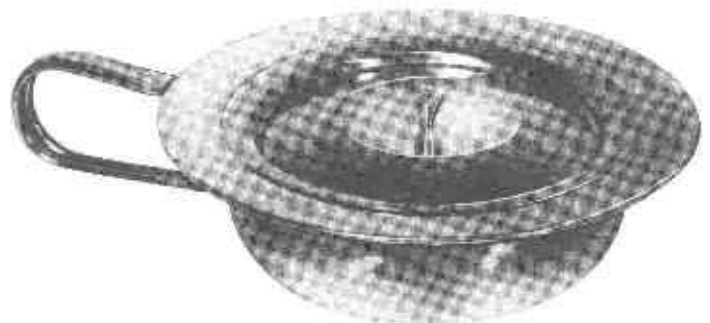

**27-185 - 186**

**27-185** Ø 235 mm  
**27-186** Ø 310 mm



# Needle Cases



**27-187**  
Sauerbruch  
210 x 125 x 17 mm



**27-188**  
Sauerbruch  
210 x 125 x 17 mm



**27-189**  
150 x 95 x 13 mm



**27-190**  
150 x 95 x 13 mm



**27-191**  
150 x 95 x 13 mm



**27-192**  
150 x 95 x 13 mm



**27-193**  
150 x 95 x 13 mm



**27-194**  
150 x 95 x 13 mm



**27-195**  
150 x 95 x 11 mm

## Storing Cases

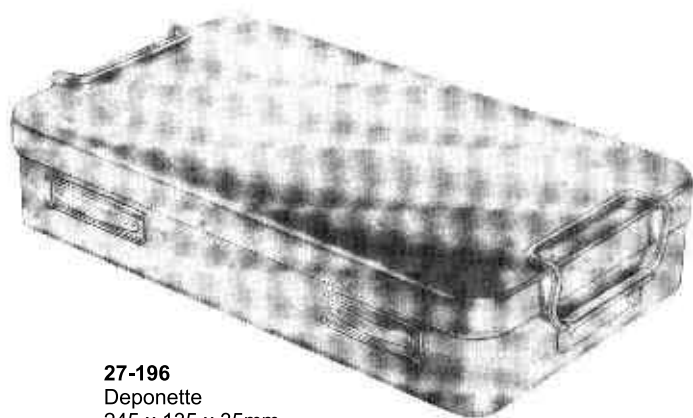

**27-196**  
Deponette  
245 x 135 x 35mm

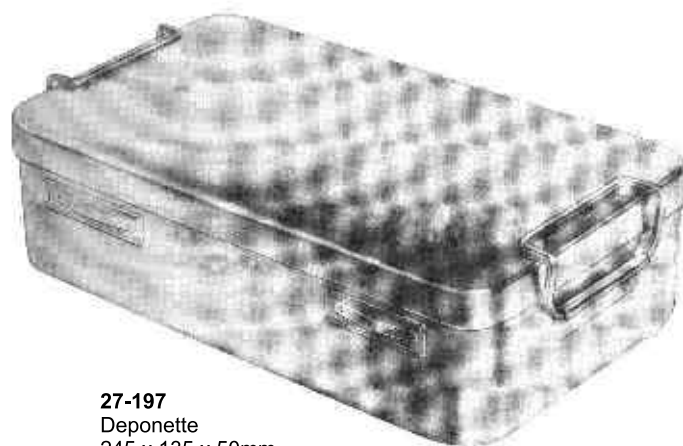

**27-197**  
Deponette  
245 x 135 x 50mm

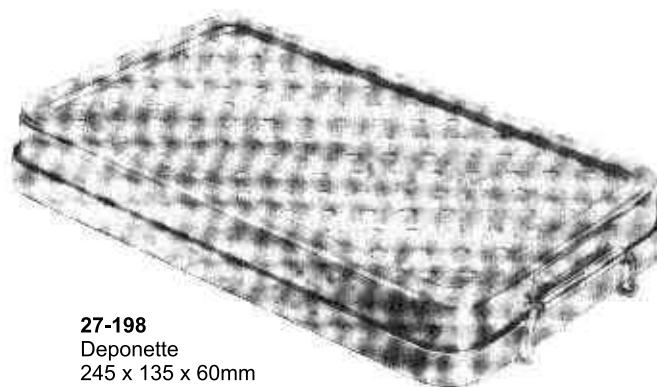

**27-198**  
Deponette  
245 x 135 x 60mm

## Storing Cases

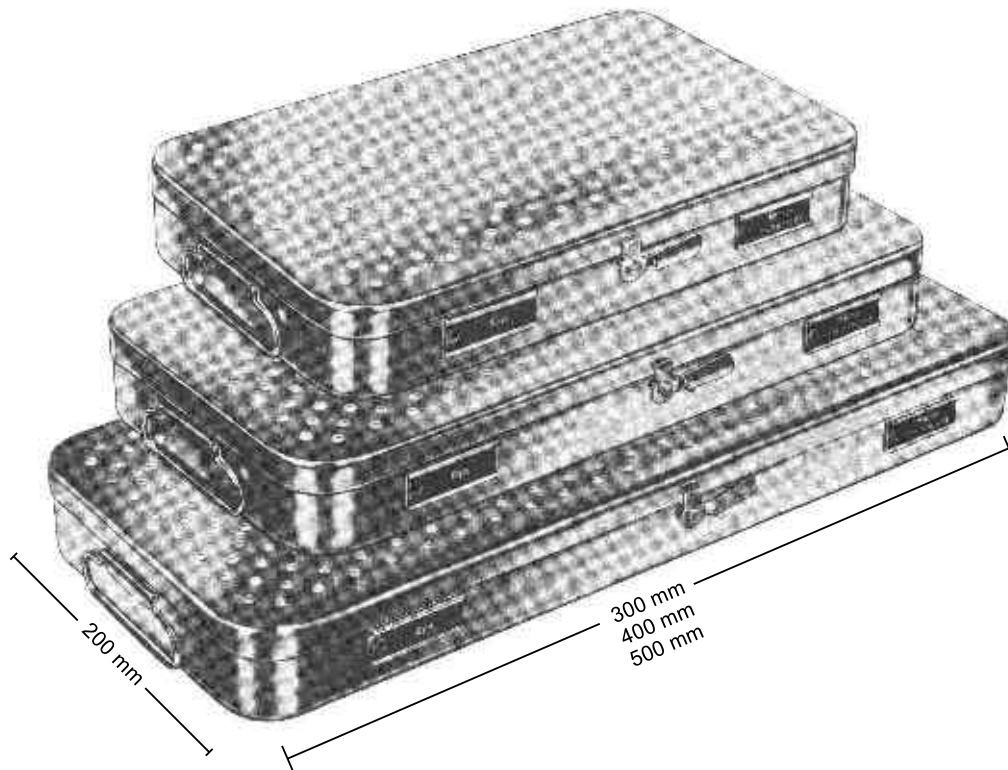

27-199 - 209

27-199	230 x 130 x 50	mm
27-200	260 x 150 x 50	mm
27-201	275 x 235 x 50	mm
27-202	300 x 200 x 50	mm
27-203	325 x 275 x 50	mm
27-204	420 x 175 x 50	mm
27-205	230 x 130 x 75	mm
27-206	260 x 150 x 75	mm
27-207	300 x 200 x 75	mm
27-208	325 x 275 x 75	mm
27-209	420 x 175 x 75	mm

# Sterilizing Baskets / Trays

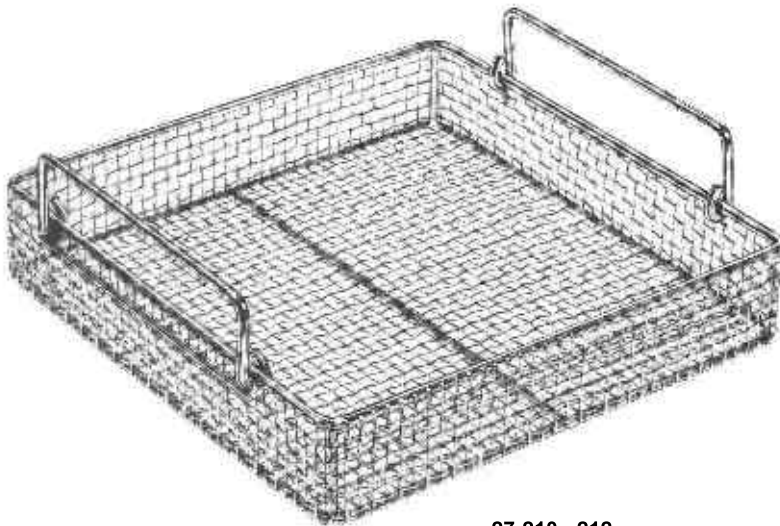

27-210 - 212

27-210	480 x 250 x 50	mm
27-211	520 x 250 x 75	mm
27-212	520 x 250 x 100	mm



27-213 - 218

27-213	240 x 240 x 50	mm
27-214	240 x 240 x 80	mm
27-215	240 x 240 x 100	mm
27-216	480 x 260 x 50	mm
27-217	520 x 260 x 80	mm
27-218	520 x 260 x 100	mm

## Sterilizing Basket

---

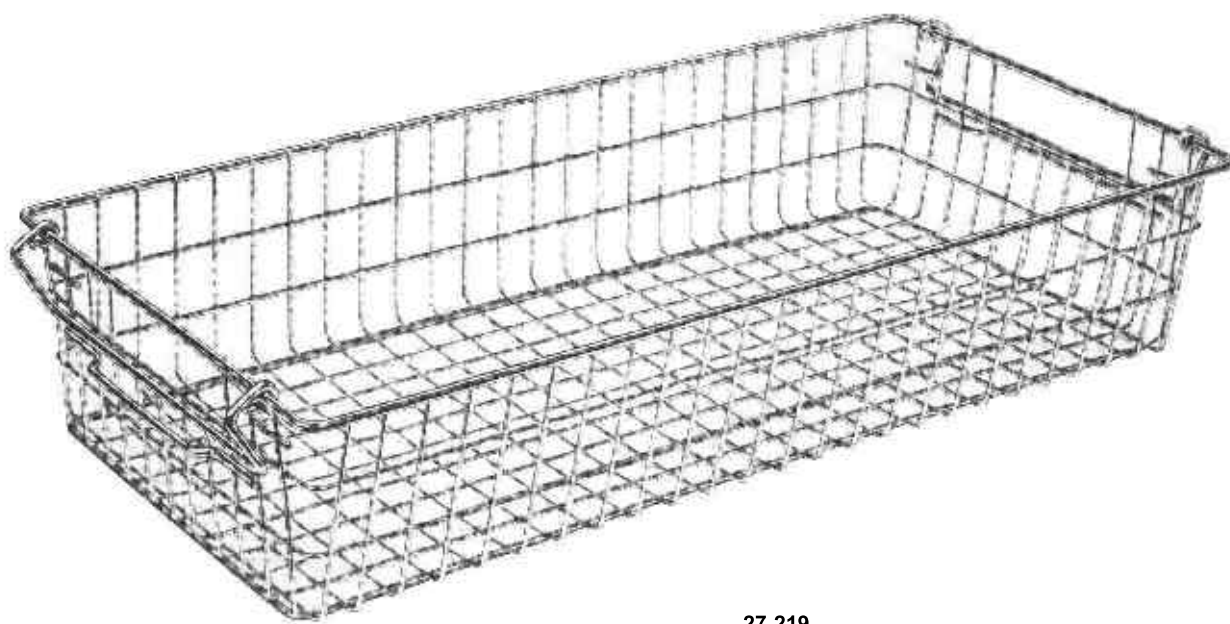

**27-219**  
(60 x 30 x 15 cm)  
Nominal dimensions